

Operating Manual and Programming Reference

Model SR780 Network Signal Analyzer



1290-D Reamwood Avenue
Sunnyvale, CA 94089 U.S.A.
Phone: (408) 744-9040 • Fax: (408) 744-9049
Email: info@thinkSRS.com • www.thinkSRS.com

Copyright © 1995, 1996, 2005, 2014, 2017
Stanford Research Systems, Inc.
All Rights Reserved

Certification

Stanford Research Systems certifies that this product met its published specifications at the time of shipment. Stanford Research Systems further certifies that its calibration measurements are traceable to the United States National Institute of Standards and Technology (NIST).

Warranty

This Stanford Research Systems product is warranted against defects in materials and workmanship for a period of one (1) year from the date of shipment.

Service

For warranty service or repair, this product must be returned to a Stanford Research Systems authorized service facility. Contact Stanford Research Systems or an authorized representative before returning this product for repair.

Information in this document is subject to change without notice.

Copyright © Stanford Research Systems, Inc., 1995, 1996, 2005, 2014, 2017
All rights reserved.

Stanford Research Systems, Inc.
1290-D Reamwood Avenue
Sunnyvale, California 94089

Printed in U.S.A.

Safety and Preparation For Use

WARNING!



Dangerous voltages, capable of causing injury or death, are present in this instrument. Use extreme caution whenever the instrument cover is removed. Do not remove the cover while the unit is plugged into a live outlet.

Caution



This instrument may be damaged if operated with the LINE VOLTAGE SELECTOR set for the wrong AC line voltage or if the wrong fuse is installed.

Line Voltage Selection

The SR780 operates from a 100V, 120V, 220V, or 240V nominal AC power source having a line frequency of 50 or 60 Hz. Before connecting the power cord to a power source, verify that the LINE VOLTAGE SELECTOR card, located in the rear panel fuse holder, is set so that the correct AC input voltage value is visible.

Conversion to other AC input voltages requires a change in the fuse holder voltage card position and fuse value. Disconnect the power cord, open the fuse holder cover door and rotate the fuse-pull lever to remove the fuse. Remove the small printed circuit board and select the operating voltage by orienting the printed circuit board so that the desired voltage is visible when pushed firmly into its slot. Rotate the fuse-pull lever back into its normal position and insert the correct fuse into the fuse holder.

Line Fuse

Verify that the correct line fuse is installed before connecting the line cord. For 100V/120V, use a 1.5 Amp fuse. For 220V/240V, use a 3/4 Amp fuse.

Line Cord

The SR780 has a detachable, three-wire power cord for connection to the power source and to a protective ground. The exposed metal parts of the instrument are connected to the outlet ground to protect against electrical shock. Always use an outlet which has a properly connected protective ground.

Service



Do not attempt to service or adjust this instrument unless another person, capable of providing first aid or resuscitation, is present.



Do not install substitute parts or perform any unauthorized modifications to this instrument. Contact the factory for instructions on how to return the instrument for authorized service and adjustment.

Fan

The fans in the SR780 are required to maintain proper operation. Do not block the vents in the chassis or the unit may not operate properly.

Contents

Safety and Preparation For Use	i
Contents	iii
Table of Figures	vii
Features	ix
Specifications	xi
Chapter 1 Getting Started	
General Installation	1-3
Front Panel Quick Start	1-4
Things To Watch Out For	1-5
Analyzing a Sine Wave	1-7
Measuring a Transfer Function	1-11
Linking (Advanced Operation)	1-15
Triggering and the Time Record	1-19
Octave Analysis	1-25
Capture	1-29
Waterfall Display	1-35
Swept Sine Measurement	1-43
Saving and Recalling	1-49
User Math Functions	1-55
Limit Testing	1-59
Exceedance Statistics	1-63
Chapter 2 Analyzer Basics	
Measurement Groups	2-3
What is an FFT?	2-4
FFT Frequency Spans	2-6
FFT Time Record	2-8
FFT Windowing	2-10
FFT Measurements	2-14
Views	2-20
FFT Averaging	2-23
Real Time Bandwidth and Overlap	2-25
Waterfall Display	2-28
Capture Buffer	2-30
The Source	2-33
Octave Analysis	2-35
Swept Sine Measurements	2-41
Trace Storage	2-48
User Math Functions	2-49
Signal Inputs	2-55
Input Connections	2-58
Intrinsic Noise Sources	2-60
External Noise Sources	2-61
Chapter 3 Operation	
Overview	3-3

Front Panel Connectors	3-6
Rear Panel Connectors	3-8
Screen Display	3-11
Status Indicators	3-17
Keypad	3-22
Normal and Alternate Keys	3-22
Menu Keys	3-23
Entry Keys	3-24
Control Keys	3-26
Function Keys	3-32
Macros	3-36

Chapter 4 Menus

Frequency Menu	4-7
FFT Frequency Menu	4-7
Octave Frequency Menu	4-12
Swept Sine Frequency Menu	4-15
Display Setup Menu	4-19
Display Options Menu	4-33
Marker Menu	4-37
Normal Marker Menu	4-40
Harmonic Marker Menu	4-43
Sideband Marker Menu	4-46
Band Marker Menu	4-49
Source Menu	4-51
Sine Source Menu	4-55
Chirp Source Menu	4-57
Noise Source Menu	4-59
Arbitrary Source Menu	4-62
Swept Sine Source Menu	4-67
Input Menu	4-71
Analog Input Menu	4-71
Playback Input Menu	4-81
Trigger Menu	4-85
Average Menu	4-91
FFT Average Menu	4-91
Octave Average Menu	4-99
Swept Sine Average Menu	4-103
User Math Menu	4-107
Window Menu	4-115
Waterfall Menu	4-119
Capture Menu	4-127
Analysis Menu	4-131
Data Table Analysis Menu	4-133

Limit Testing Analysis Menu	4-135
Marker Statistics Analysis Menu	4-139
Exceedance Statistics Analysis Menu	4-142
Disk Menu	4-145
Recall Settings Menu	4-149
Disk Buffers Menu	4-152
Disk Upkeep Menu	4-158
Output Menu	4-161
System Menu	4-169
System Remote Menu	4-172
System Preferences Menu	4-174
System Date/Time Menu	4-176
System Diagnostics Menu	4-177
Edit Macro Menu	4-180
Chapter 5 Programming	
Index of Commands	5-2
Alphabetical List of Commands	5-11
Introduction	5-19
Command Syntax	5-23
Frequency Commands	5-25
Display Setup Commands	5-31
Display Options Commands	5-35
Marker Commands	5-37
Source Commands	5-44
Input Commands	5-51
Trigger Commands	5-55
Average Commands	5-56
User Math Commands	5-61
Window Commands	5-63
Waterfall Commands	5-65
Capture Commands	5-68
Memory Allocation Commands	5-69
Data Table Commands	5-70
Limit Test Commands	5-72
Marker Statistics Commands	5-74
Exceedance Statistics Commands	5-75
Disk Commands	5-76
Output Commands	5-79
System Commands	5-82
Front Panel Commands	5-84
Data Transfer Commands	5-89
Interface Commands	5-101
Nodal Degree-of-Freedom Commands	5-102
Status Reporting Commands	5-104
Status Word Definitions	5-108
Example Program	5-113

Chapter 6 File Conversion

Why File Conversion	6-2
Supported External File Types	6-3
SR780 File Types	6-4
Using the File Conversion Utility	6-5

Table of Figures

Figure 2-1 Waterfall Display	2-28
Figure 2-2 Transfer Functions	2-42
Figure 2-3 Capacitive Coupling	2-61
Figure 2-4 Inductive Coupling	2-62
Figure 2-5 Resistive Coupling	2-63
Figure 3-1 Front Panel	3-3
Figure 3-2 Rear Panel	3-8
Figure 3-3 Dual Display Screen	3-11
Figure 3-4 Single Display Screen	3-12
Figure 3-5 Vertical Scale Bar	3-13
Figure 3-6 Horizontal Scale Bar	3-14
Figure 3-7 Marker Region	3-14
Figure 3-8 Marker Position Bar	3-15
Figure 3-9 Status Indicator Panel	3-17
Figure 3-10 Front Panel Keypad	3-22

Features

Measurements

FFT Group

FFT	Time Record	Windowed Time
Time Capture	Transfer Function	Cross Spectrum
Coherence	Cross Correlation	Autocorrelation
Orbit	User Math Functions	

Octave Analysis Group

1/1, 1/3, 1/12 Octave	Time Capture	User Math Functions
L_{EQ}	Impulse	Reverberation

Swept Sine Group

Spectrum	Transfer Function	Cross Spectrum
User Math Functions		

Views

Log Magnitude	Linear Magnitude	Magnitude Squared
Real Part	Imaginary Part	Phase
Unwrapped Phase	Nichols Plot	Nyquist Plot

Displays

Single	Dual Upper/Lower	Waterfall with Skew
Zoom and Pan		

FFT Resolution

100, 200, 400 or 800 FFT lines

FFT Windows

Hanning	Blackman-Harris	Flattop
Kaiser	Uniform	Force/Exponential
User defined	$[-T/2..T/2]$	$[-T/4..T/4]$
$[0..T/2]$		

Averaging

RMS	Vector	Peak Hold
Linear or Exponential	Preview Time Records	Equal Confidence

Analysis

Harmonic	Sideband	Band
THD/THD+N	Limit Testing	Data Table
Exceedance (L_N)	Statistics	Waterfall Slice

User Math

+, -, *, /	Conjugate	Magnitude/Phase
Real/Imaginary	Sqrt	FFT/Inverse FFT
$j\omega$	Log/Exp	d/dx
Group Delay	A, B, C Wt	

Source Outputs

Sine	Two Tone	Swept Sine
White/Pink Noise	Burst Noise	Chirp
Burst Chirp	Arbitrary	

Trigger

Free Run	External (Analog and TTL)	
Internal	Source	Auto/Manual Arming

Time Capture

Capture time data for later analysis (FFT or Octave). Up to 2M samples of data can be saved.

Storage 3.5", 1.44 Mbytes, DOS formatted disk. Save data, setups and hardcopy.

Hard Copy Print to dot matrix or LaserJet/InkJet printers. Plot to HPGL or Postscript plotters. Print/Plot on-line (serial, parallel or IEEE-488) or to disk file. GIF, EPS and PCX graphic formats available for disk output.

Interfaces RS232 serial, Centronics parallel and IEEE-488.

Help On screen help system provides Operating Manual and Programming Reference on-line.

Specifications

Specifications apply after 30 minutes of warm-up and within 2 hours of last auto-offset. All specifications are with 400 line FFT resolution and anti-alias filters enabled unless stated otherwise.

Frequency

Range	102.4 kHz or 100 kHz (both displays have the same range).
FFT Spans	195.3 mHz to 102.4 kHz or 191 mHz to 100 kHz. The 2 displays can have different spans and start frequencies.
FFT Resolution	100, 200, 400 or 800 lines
Real Time Bandwidth	102.4 kHz (highest FFT span with continuous data acquisition and averaging on both inputs).
Accuracy	25 ppm from 20° to 40°C

FFT Dynamic Range

Dynamic Range	-90 dBfs typical, -80 dBfs guaranteed (FFT and Octave), 145 dB (Swept Sine). Includes spurs, harmonic and intermodulation distortion and alias products. Excludes alias responses at extremes of span.
Harmonic Distortion	<-80 dB (Single tone in band).
Intermodulation Distortion	<-80 dB (Two tones in band, each <- 6.02 dBfs).
Spurious	<-80 dBfs
Alias Responses	<-80 dBfs (Single tone outside of span, < 0 dBfs, < 1 Mhz).
Full Span FFT Noise Floor	-100 dBfs typical (Input grounded, Input Range > -30 dBV, Hanning window, 64 RMS averages).
Residual DC Response	< -30 dBfs (FFT with Auto Cal On).

Amplitude Accuracy

Single Channel	± 0.2 dB (excluding windowing effects).
Cross Channel	± 0.05 dB (dc to 102.4 kHz) (Transfer Function measurement, both inputs on the same Input Range, RMS averaged).

Phase Accuracy

Single Channel	± 3.0 deg relative to External TTL trigger. (-50 dBfs to 0 dBfs, freq < 10.24 kHz) (Center of frequency bin, DC coupled) For Uniform, Blackman-Harris, Hanning, Flattop and Kaiser windows, phase is relative to a cosine wave at the center of the time record. For Force and Exponential windows, phase is relative to a cosine wave at the beginning of the time record.
Cross Channel	± 0.5 deg (dc to 51.2 kHz) ± 1.0 deg (dc to 102.4 kHz) (Transfer Function measurement, both inputs on the same Input Range, Vector averaged.)

Signal Inputs

Number of Inputs	2
Full Scale Input Range	-50 dBV (3.16 mVpk) to +34 dBV (50 Vpk) in 2 dB steps.
Maximum Input Level	57 Vpk
Input Configuration	Single-ended (A) or True Differential (A-B).
Input Impedance	1 M Ω + 50 pF
Shield to Chassis	Floating Mode: 1 M Ω + 0.01 μ F Grounded Mode: 50 Ω Shields are always grounded in differential input (A-B).
Maximum Shield Voltage	4 Vpk
AC Coupling	-3 dB rolloff at 0.16 Hz.
CMRR	90 dB at 1 kHz (Input Range < 0 dBV). 80 dB at 1 kHz (Input Range <10 dBV). 50 dB at 1 kHz (Input Range \geq 10 dBV).
ICP Signal Conditioning	Current Source: 4.8 mA Open Circuit Voltage +26 V
A-weight Filter	ANSI Standard S1.4-1983; 10 Hz to 25.6 kHz, Type 0 Tolerance.
Crosstalk	<-145 dB below signal, (Input to Input and Source to Inputs, 50 Ω receiving input source impedance).
Input Noise	<10 nVrms/ \sqrt Hz (< -160 dBVrms/ \sqrt Hz) above 200 Hz.

Trigger Input

Modes	Continuous, Internal, External, or External TTL.
Internal	Level adjustable to \pm 100% of input scale. Positive or Negative slope. Minimum Trigger Amplitude: 5% of input range
External	Level adjustable to \pm 5V in 40 mV steps. Positive or Negative slope. Input Impedance: 1 M Ω Max Input: \pm 5V Minimum Trigger Amplitude: 100 mV
External TTL	Requires TTL level to trigger (low<0.7V, high>3.0V).
Post-Trigger	Measurement record is delayed up to 8192 samples after the trigger.
Pre-Trigger	Measurement record starts up to 8192 samples prior to the trigger.

Time Capture

Mode	Continuous real time data recording to memory.
Maximum Rate	262,144 samples/sec for both inputs. Lower rates may be used for longer capture.
Maximum Capture Length	2M samples standard, 4M and 8M samples optional.

Octave Analysis

Standards	Conforms to ANSI S1.11-1986, Order 3, Type 1-D.
Frequency Range	Band centers: Single Channel

	1/1 Octave	0.125 Hz - 32 kHz
	1/3 Octaves	0.100 Hz - 40 kHz
	1/12 Octaves	0.091 Hz - 12.34 kHz
	Two Channels	
	1/1 Octave	0.125 Hz - 16 kHz
	1/3 Octaves	0.100 Hz - 20 kHz
	1/12 Octaves	0.091 Hz - 6.17 kHz
Accuracy	< 0.2 dB (1 second stable average, single tone at band center).	
Dynamic Range	80 dB (1/3 Octave, 2 second stable average), per ANSI S1.11-1986.	
Sound Level	Exponential time averaged broadband power (L), per ANSI S1.4-1983, Type 0. Broadband Impulse and Peak power, per IEC 651-1979, Type 0. Sum of octave bands total power.	

Source Output

Amplitude Range	0.1 mVpk to 5 Vpk
Amplitude Resolution	0.1 mVpk
DC Offset	<10.0 mV (typical)
Output Impedance	< 5 Ω ; \pm 100 mA peak output current.

Sine

Amplitude Accuracy	\pm 1% of setting, 0 Hz to 102.4 kHz 0.1 Vpk to 5.0 Vpk, high impedance load.
Offset	0 V to \pm 5 V, max output \pm 5 V (ac+dc).
Harmonics, Sub-Harmonics and Spurious Signals	0.1 Vpk to 5 Vpk, 0 V offset, <-80 dBc (fundamental < 30 kHz), <-74 dBc (fundamental > 30 kHz).

Two Tone

Amplitude Accuracy	\pm 1% of setting, 0 Hz to 102.4 kHz 0.1 Vpk to 5 Vpk, high impedance load.
Offset	0 V to \pm 5 V, max output \pm 5 V (ac+dc).
Harmonics, Sub-Harmonics and Spurious Signals	0.1 Vpk to 2.5 Vpk, 0 V offset, < -80 dBc (fundamental < 30 kHz), <-74 dBc (fundamental > 30 kHz).

White Noise

Time Record	Continuous or Burst
Bandwidth	DC to 102.4 kHz or limited to analysis span.
Flatness	<0.25 dB pk-pk (typical), <1.0 dB pk-pk (max), (5000 rms averages).

Pink Noise

Time Record	Continuous or Burst
Bandwidth	DC to 102.4 kHz
Flatness	<2.0 dB pk-pk, 20 Hz - 20 kHz, (measured using averaged 1/3 Octave Analysis).

Chirp

Time Record Continuous or Burst
Output Sine sweep across the FFT span.
Flatness ±0.25 dB pk-pk, Amplitude = 1.0 Vpk.
Crest Factor 1.94 (5.77 dB)

Swept Sine

Auto Functions Source Level, Input Range and Frequency Resolution.
Dynamic Range 145 dB

Arbitrary

Amplitude Range ± 5V
Record Length 2M samples (playback from Arbitrary Waveform memory or
 a Capture buffer),
 4M and 8M samples optional.
 Variable output sample rate.

General

Monitor Monochrome CRT, 800H by 600V resolution.
Interfaces IEEE-488, RS232 and Printer interfaces standard.
 All instrument functions can be controlled through the
 IEEE-488 and RS232 interfaces. A PC (XT) keyboard input is
 provided for additional flexibility.
Hardcopy Print to dot matrix and HP LaserJet/InkJet compatible printers.
 Plot to HPGL or Postscript plotters. Print/Plot to RS232 or
 IEEE-488 interfaces or to disk file. Additional file formats
 include GIF, PCX and EPS.
Disk 3.5 inch DOS compatible format, 1.44 Mbytes capacity.
 Storage of data, setups and hardcopy.
Preamp Power Power connector for SRS preamplifiers.
Power 70 Watts, 100/120/220/240 VAC, 50/60 Hz.
Dimensions 17"W x 8"H x 22"D
Weight 56 lb.
Warranty One year parts and labor on materials and workmanship.

Chapter 1

Getting Started

These example measurements are designed to acquaint the first time user with the SR780 Network Analyzer. They provide a foundation for understanding how to use the SR780. For a more complete overview of the instrument and its capabilities, refer to the ‘Analyzer Basics’ and ‘Operation’ sections of this manual.

Many of the examples use the test filter enclosed with this manual. The filter is a simple twin-tee 1 kHz passive notch filter. This filter provides an interesting transfer function for these measurements.

In This Chapter

General Installation	1-3	Analyzing a Sine Wave	1-7
Caution	1-3	Measuring a Transfer Function	1-11
Line Voltage Selection	1-3	Linking (Advanced Operation)	1-15
Line Fuse	1-3	Triggering and the Time Record	1-19
Line Cord	1-3	Octave Analysis	1-25
Power Switch	1-3	Capture	1-29
Screen Brightness	1-3	Waterfall Display	1-35
Fan	1-3	Swept Sine Measurement	1-43
Front Panel Quick Start	1-4	Saving and Recalling	1-49
[Hardkeys]	1-4	User Math Functions	1-55
<Softkeys>	1-4	Limit Testing	1-59
Knob	1-4	Exceedance Statistics	1-63
Help	1-4		
Things To Watch Out For	1-5		
Start	1-5		
Live Display	1-5		
Narrow Span	1-5		
Low Detection Frequency	1-5		
Averaging	1-5		
Triggering	1-5		
Scaling and Ranging	1-6		
Local	1-6		
Reset	1-6		

General Installation

Caution



This instrument may be damaged if operated with the LINE VOLTAGE SELECTOR set for the wrong AC line voltage or if the wrong fuse is installed.

Line Voltage Selection

The SR780 operates from a 100V, 120V, 220V, or 240V nominal AC power source having a line frequency of 50 or 60 Hz. Before connecting the power cord to a power source, verify that the LINE VOLTAGE SELECTOR card, located in the rear panel fuse holder, is set so that the correct AC input voltage value is visible.

Conversion to other AC input voltages requires a change in the fuse holder voltage card position and fuse value. Disconnect the power cord, open the fuse holder cover door and rotate the fuse-pull lever to remove the fuse. Remove the small printed circuit board and select the operating voltage by orienting the printed circuit board so that the desired voltage is visible when pushed firmly into its slot. Rotate the fuse-pull lever back into its normal position and insert the correct fuse into the fuse holder.

Line Fuse

Verify that the correct line fuse is installed before connecting the line cord. For 100V/120V, use a 1.5 Amp fuse. For 220V/240V, use a 3/4 Amp fuse.

Line Cord

The SR780 has a detachable, three-wire power cord for connection to the power source and to a protective ground. The exposed metal parts of the instrument are connected to the outlet ground to protect against electrical shock. Always use an outlet which has a properly connected protective ground.

Power Switch

The power switch is on the rear panel. Turn the unit on by depressing the upper half of the power switch. The green power LED on the front panel indicates that the unit is powered.

Screen Brightness

If the screen is too dark or too bright, adjust the brightness using the Brighter and Dimmer buttons below the softkeys (below right of the display). Do not set the brightness higher than necessary.

Fan

The fans in the SR780 are required to maintain proper operation. Do not block the vents in the chassis or the unit may not operate properly.

Front Panel Quick Start

There are two types of front panel keys which are referenced in this section. Hardkeys are those keys with labels printed on them. Their function is determined by the label and does not change. Hardkeys are referenced by brackets like this - [Hardkey]. Softkeys are the ten gray keys along the right edge of the screen. Their function is labeled by a menu box displayed on the screen next to the key. Softkey functions change depending upon the menu and instrument configuration. Softkeys are referenced as the <Softkey>.

[Hardkeys]

The keypad consists of four groups of hardkeys (keys with printed labels).

The ENTRY keys are used to enter numeric parameters which have been highlighted by a softkey. The MENU keys select a menu of softkeys. Pressing a menu key will change the menu boxes which are displayed next to the softkeys. Each menu presents a group of similar or related parameters and functions. The CONTROL keys start and stop data acquisition, toggle the active display and link parameters and functions. These keys are not in a menu since they are used frequently and within any menu. The FUNCTION keys perform common functions such as Auto Scale and Auto Range. These keys can be accessed at any time.

<Softkeys>

The SR780 has a menu driven user interface. The Menu keys each display a menu of softkeys. The softkeys are at the right of the video display and have different functions depending upon the displayed menu.

There are three types of softkeys - buttons, lists and numeric values. A button performs a function, such as <Full Span>. A list presents a list of choices or options in the entry field (at the top of the screen). Use the knob to make a selection and press [Enter]. <Measurement> is an example of a list. A numeric value presents the current value in the entry field and awaits numeric entry. Enter a new value with the entry keys and press [Enter]. <Start Freq> is an example of a numeric value.

Knob

The knob normally moves the markers within the displays. If a parameter has been highlighted by its softkey, the knob adjusts the parameter. List parameters are most easily modified with the knob. Numeric parameters may also be adjusted with the knob.

Knob list selections are referenced in parenthesis like (Hanning).

Help



Enter the on screen help system by pressing [Help/Local]. Help on any hardkey or softkey is available simply by pressing the key. Press [1] for the Help Index. Press [0] to exit the help system and return to normal operation.

Things To Watch Out For

If the analyzer is on but doesn't seem to be taking data, there are a number of things to check.

Start

Press the [Start/Reset] key to start the measurements. Make sure the Run/Pause indicator at the top of the screen displays 'RUN' instead of 'PAUSE'.

Live Display

If the displays are showing recalled trace data, they are Off-Line and do not display the live measurement data. Set the Display to Live instead of Off-Line (in the [Display Options] menu).

Narrow Span

If the FFT span is very narrow, the time record is very long (up to 1000's of seconds). Completely new data is available only every time record. Change the Time Record Increment in the [Average] menu) to display overlapped data more often.

Low Detection Frequency

Swept Sine measurements at very low frequencies ($\ll 1$ Hz) take a very long time (at least 2 cycles and maybe longer). Do not set the sweep Start to a very low frequency to measure the DC response.

Octave measurements with a very low starting band take a long time to settle before the first measurement is valid. The settling time is related to the bandwidth of the lowest octave band. If the Lowest Band is less than 1 Hz, the settling time can be very long.

Averaging

Very long averaging times for any measurement may give the appearance that the display does not update. Check the FFT Number Of Averages, the Octave Integration Time or the Swept Sine Integration Time.

When Linear averaging is on, the measurement is paused after the average is completed (unless triggered or waterfall storage is on). Press [Start/Reset] to take another average.

Triggering

If the analyzer is waiting for a trigger, the Trig Wait indicator at the top of the screen is on.

If the measurement is not meant to be triggered, make sure the Trigger Mode is Free Run.

If the measurement is meant to be triggered, make sure that the correct Trigger Source is selected and the Trigger Level is appropriate for the trigger signal.

Check that the Trigger Mode is set to Auto Arm. If the Trigger Mode is Manual Arm, then the analyzer will only trigger once and then wait for the next Manual Arm command.

Scaling and Ranging

Check that the inputs are not completely overloaded by using [Auto Range Ch1] and [Auto Range Ch2].

Scale the display to show the entire range of the data with [Auto Scale A] and [Auto Scale B].

Local

Make sure that the analyzer is not in the REMOTE state where the computer interfaces have setup the instrument and locked out the front panel. Press the [Local/Help] key to restore local control.

Reset

If the analyzer still seems to function improperly, turn the power off and turn it back on while holding down the [<-] (backspace) key. This will reset the analyzer into the default configuration. The analyzer should power on running and taking measurements.

Analyzing a Sine Wave

This measurement investigates the spectrum of a 1.024 kHz sine wave. You will use the SR780 source to provide the sine signal (or you can use a function generator capable of providing a 1.024 kHz sine wave at a level of 100 mV to 1 V, such as the SRS DS345). The actual settings of the generator are not important since you will be using the SR780 to measure and analyze its output.

<p>1. Press [System]</p> <p>Press <Preset></p> <p>Press [Enter] to confirm Preset.</p>	<p>Display the System menu.</p> <p>Preset returns the unit to its default settings.</p> <p>Preset requires confirmation to prevent accidental reset. Wait until the self tests are completed.</p>
<p>2. Connect the Source Output to the Channel 1 A Input.</p> <p>(Or connect a function generator's output to the Ch1 A Input of the analyzer.)</p>	<p>Setup to analyze the source output.</p> <p>(The input impedance of the analyzer is 1 MΩ. The generator may require a terminator. Many generators have either a 50 Ω or 600 Ω output impedance. Use the appropriate feedthrough termination if necessary. In general, not using a terminator means that the output amplitude will not agree with the generator setting and the distortion may be greater than normal.)</p>
<p>3. Press [Source]</p> <p>Press <Sine></p> <p>Press <Frequency 1></p> <p>Press [1] [.] [0] [2] [4], select (kHz) with the knob, and press [Enter].</p> <p>(Or turn on the generator, set the frequency to 1.024 kHz and the amplitude to approximately 1 V_{rms}.)</p>	<p>Select the Source menu.</p> <p>Choose Sine output.</p> <p>Adjust the output Frequency.</p> <p>Enter 1.024 kHz for the Frequency. Enter the value with the numeric entry keys. Select the units with the knob. Enter the new value with the [Enter] key.</p> <p>(Setup the function generator for 1.024 kHz sine output.)</p>
<p>4. Press [Auto Range Ch1]</p>	<p>Let the analyzer automatically set the Input Range to agree with the signal (either from the Source or function generator). Note that the Ch1 Input Range readout at the top of the screen is displayed in inverse when Ch1 Auto Range is on.</p>

1-8 Analyzing a Sine Wave

<p>5. Press [Freq]</p> <p>Press </p> <p>Use the knob to adjust the Span to 6.4 kHz and press [Enter].</p>	<p>Select the Frequency menu.</p> <p>Adjust the FFT Span.</p> <p>Set the Span to display the signal and its first few harmonics.</p>
<p>6. Press [Display Options]</p> <p>Press <Format></p> <p>Select (Single) with the knob and press [Enter].</p>	<p>Select the Display Options menu.</p> <p>Choose a new Display Format.</p> <p>Select the desired option from the displayed list and press [Enter]. Single Display Format shows a single large graph.</p>
<p>7. Press [Auto Scale A]</p> <p>Press [Marker Max]</p>	<p>Automatically scale DisplayA (the active display) to show the entire range of the measurement.</p> <p>This moves the Marker to the maximum data point in the active display (A). The Marker should now be on the 1.024 kHz signal. The Marker Position shown above the graph displays the frequency and amplitude of the signal.</p>
<p>8. Use the knob to move the Marker around. Take a look at some of the harmonics.</p>	<p>The knob normally adjusts the Marker Position within the active display (DisplayA in this case). If a menu box is highlighted with a softkey, the knob adjusts the selected parameter shown in the entry field at the top of the screen.</p>
<p>9. Let's look at the fundamental only.</p> <p>Press [Span Down] twice to decrease the Span to 1.6 kHz. The Stop Frequency shown at the bottom right of the graph should read 1.6 kHz.</p> <p>Press [Marker Max]</p> <p>Press [Marker Center]</p>	<p>You can also use the [Span Up] and [Span Down] keys to adjust the Span.</p> <p>This isolates the 1.024 kHz fundamental frequency. You may notice that the spectrum takes a noticeable time to settle at this last span. This is because the time record is 250 ms long.</p> <p>Move the Marker to the peak.</p> <p>This sets the span Center Frequency to the Marker Position (for the active display). The signal will be at the center of the span. Further adjustments to the span will keep the center frequency fixed.</p>
<p>10. Let's look at the signal distortion.</p> <p>Press [Freq]</p>	<p>Select the Frequency menu.</p>

<p>Press </p> <p>Enter [1] [2] [.] [8], select (kHz) with the knob, and press [Enter].</p> <p>Press [Auto Scale A]</p>	<p>Adjust the Span.</p> <p>You can also use the numeric keypad to enter the span.</p> <p>Enter the 12.8 kHz span numerically. Note that the Center Frequency is no longer 1.024 kHz. This is because a 12.8 kHz span cannot be centered below 6.4 kHz without starting at a negative frequency.</p> <p>Adjust the graph scale and reference to display the entire range of the data. This key can be used at any time.</p>
<p>11. Let's measure some harmonics using the Marker Reference.</p> <p>Press [Marker Max]</p> <p>Press [Marker Ref]</p> <p>Use the knob to move the Marker to the harmonics.</p> <p>Press [Marker Ref]</p>	<p>Move the Marker to the fundamental peak.</p> <p>Set the Marker Offset or Reference to the amplitude of the fundamental. The Marker Position above the graph now reads relative to this offset (~0 dB). This is indicated by the Δ in front of the Marker Position reading. A small flag shaped symbol is located at the screen location of the reference.</p> <p>The Marker Position shows the distortion peaks relative to the fundamental.</p> <p>Pressing [Marker Ref] again removes the Marker Offset and returns the Marker to absolute readings.</p>
<p>12. Let's have the analyzer measure the distortion.</p> <p>Press [Marker]</p> <p>Press <Mode></p> <p>Select (Harmonic) with the knob and press [Enter].</p> <p>Press <# Harmonics></p> <p>Use the knob to adjust the Number Of Harmonics to 10 and press [Enter].</p>	<p>Select the Marker menu.</p> <p>Adjust the Marker Mode.</p> <p>Choose the Harmonic Marker for the active display.</p> <p>Adjust the Number Of Harmonics for analysis.</p> <p>Enter 10 harmonics.</p>

1-10 Analyzing a Sine Wave

Press [Marker Max]

Move the Marker to the peak (fundamental).

Notice that Harmonic Markers (little triangles) appear on top of all of the harmonic peaks. These indicate which data points are used in the harmonic calculations.

The harmonic calculations are displayed within the menu. THD (total harmonic distortion) is relative to the fundamental. Harmonic power is an absolute measurement of the harmonic power level.

This concludes this measurement example. You should have a feeling for the basic operation of the menus, knob and numeric entry, marker movement and some function keys.

Measuring a Transfer Function

This example investigates the transfer function of the test filter (enclosed with this manual) using FFT measurements. You will use the SR780 source to provide a broad band chirp and both input channels to measure the input to and output from the device under test.

<p>1. Press [System]</p> <p>Press <Preset></p> <p>Press [Enter] to confirm Preset.</p>	<p>Display the System menu.</p> <p>Preset returns the unit to its default settings.</p> <p>Preset requires confirmation to prevent accidental reset. Wait until the self tests are completed.</p>
<p>2. Use a BNC Tee to connect the Source Output to the filter input and the Ch1 A Input.</p> <p>Connect the filter output to the Ch2 A Input.</p>	<p>In this instrument, transfer function is defined as Ch2 response over Ch1 reference. Thus, Ch1 monitors the filter input (source output) and Ch2 measures the response of the device under test.</p>
<p>3. Press [Source]</p> <p>Press <Chirp></p> <p>Press [Window]</p> <p>Press <Window></p> <p>Select (Uniform) with the knob and press [Enter].</p>	<p>Select the Source menu.</p> <p>Choose Chirp output. The output is an equal amplitude sine wave at each frequency bin of the FFT spectrum.</p> <p>Select the Window menu.</p> <p>Adjust the FFT Window function.</p> <p>The Chirp source requires the use of the Uniform window since not all chirp frequency components are present at all points in the time record. The chirp is exactly periodic with the FFT time record and does not 'leak' with the uniform window.</p>
<p>4. Press [Auto Range Ch1]</p> <p>Press [Auto Range Ch2]</p>	<p>Let the analyzer automatically set the Input Ranges to agree with the signals. Note that the Input Range readouts at the top of the screen are displayed in inverse when Auto Range is on.</p>
<p>5. Press [Freq]</p> <p>Press </p> <p>Use the knob to adjust the Span to 6.4 kHz and press [Enter].</p>	<p>Select the Frequency menu.</p> <p>Adjust the FFT Span.</p> <p>Set the Span to display the filter notch at 1 kHz.</p>

1-12 Measuring a Transfer Function

	<p>The top display (A) is measuring the filter input and should show a fairly flat spectrum. The bottom display (B) is measuring the filter output and should show a deep notch.</p> <p>Both displays are measuring absolute signal levels.</p>
<p>6. Press [Display Setup]</p> <p>Press <Measurement></p> <p>Select (<F2/F1>) with the knob and press [Enter].</p> <p>Press <Units></p> <p>Select (dB) with the knob and press [Enter].</p> <p>Press [Auto Scale A]</p>	<p>Select the Display Setup menu.</p> <p>Adjust the Measurement of the active display (A).</p> <p>Choose Transfer Function for the Measurement in DisplayA (top).</p> <p>Transfer Function is the ratio of the response (Ch2) to the input (Ch1) and is a unitless quantity.</p> <p>Change the Units.</p> <p>Choose dB units for the Transfer Function.</p> <p>Adjust the scale and reference for DisplayA to show the entire range of the data.</p>
<p>7. Press [Marker]</p> <p>Press <Width></p> <p>Select (Normal) with the knob and press [Enter].</p> <p>Press <Seeks></p> <p>Select (Min) with the knob and press [Enter].</p> <p>Move the Marker Region with the knob to find the notch frequency and depth. Or press [Marker Min].</p>	<p>Select the Marker menu.</p> <p>Adjust the Marker Width for DisplayA.</p> <p>Change to Normal Width (1/2 division).</p> <p>Adjust what the Marker Seeks within the Marker Region.</p> <p>Seek the Minimum of the data within the Marker Region.</p> <p>The Marker Region makes it easy to find narrow peaks and valleys in the graph. The notch should be around 1 kHz and about -60 dB deep.</p>
<p>8. Press [Display Options]</p> <p>Press <X-Axis></p> <p>Select (Log) with the knob and press [Enter].</p>	<p>Select the Display Options menu.</p> <p>The graph might look better on a log x axis.</p> <p>Log scale is a common way to display filter response functions.</p>
<p>9. Let's show phase response on DisplayB (bottom).</p>	<p>The two displays have separate Measurements.</p>

<p>Press [Active Display]</p> <p>Press [Display Setup]</p> <p>Press <Measurement></p> <p>Select (<F2/F1>) with the knob and press [Enter].</p> <p>Press <View></p> <p>Select (Phase) with the knob and press [Enter].</p> <p>Press [Auto Scale B]</p>	<p>Make DisplayB the active display. The active display has its Marker Position Bar (above the graph) highlighted.</p> <p>Select the Display Setup menu. The setup of DisplayB (the active display) is now shown in the menu.</p> <p>Adjust the Measurement of DisplayB.</p> <p>Choose Transfer Function also.</p> <p>The measured data is a set of complex values which can be viewed in a number of different ways.</p> <p>Choose Phase View to show the phase of the transfer function.</p> <p>Scale DisplayB to show the entire phase transfer function.</p>
<p>10. Press [Display Options]</p> <p>Press <X-Axis></p> <p>Select (Log) with the knob and press [Enter].</p>	<p>Select the Display Options menu.</p> <p>The graph looks better on a log x axis.</p> <p>Now both displays have a log x axis.</p>
<p>11. Let's link the Markers together.</p> <p>Press [Active Display]</p> <p>Press [Marker]</p> <p>Press <Width></p> <p>Select (Spot) with the knob and press [Enter].</p>	<p>Make DisplayA (top) the active display.</p> <p>Select the Marker menu.</p> <p>Adjust the Marker Width of DisplayA.</p> <p>Change the Marker Width to Spot.</p>
<p>12. Press [Link] and use the knob to move the marker.</p> <p>Press [Enter]</p>	<p>The [Link] key links the two display markers together. This allows simultaneous readout of Transfer Function Magnitude (top) and Phase (bottom).</p> <p>Pressing any key removes the link between the markers.</p>

1-14 Measuring a Transfer Function

To permanently link the Markers, go to the Marker menu.

Press [Marker]

Press <Marker>

Select (Link) with the knob and press [Enter].

Move the Marker with the knob.

Select the Marker menu.

Adjust the Marker Type.

Linked Markers move together. Since we changed the DisplayA Marker to Linked, moving the DisplayA Marker moves the DisplayB Marker.

If DisplayB is active, moving its Marker does not move the DisplayA Marker. To do this, change the DisplayB Marker Type to Linked also.

This concludes this measurement example. You should have a feeling for the basic operation of two channel measurements and the use of [Active Display].

Linking (Advanced Operation)

This example investigates the test filter (enclosed with this manual) using FFT measurements. You will use the SR780 source to provide a broad band source and both displays to measure the output of the device under test. Display parameter linking and function linking will be explored in greater detail.

<p>1. Press [System]</p> <p>Press <Preset></p> <p>Press [Enter] to confirm Preset.</p>	<p>Display the System menu.</p> <p>Preset returns the unit to its default settings.</p> <p>Preset requires confirmation to prevent accidental reset. Wait until the self tests are completed.</p>
<p>2. Connect the Source Output to the filter input.</p> <p>Connect the filter output to the Ch2 A Input.</p>	<p>In this example, only the filter output on Channel 2 is required.</p>
<p>3. Press [Source]</p> <p>Press <Noise></p> <p>Press <Type></p> <p>Select (White) with the knob and press [Enter].</p>	<p>Select the Source menu.</p> <p>Choose Noise output. The output is random noise.</p> <p>Adjust the Noise Type.</p> <p>This source is White Noise which extends over the entire 0-102.4 kHz frequency range.</p>
<p>4. Press [Auto Range Ch2]</p>	<p>Let the analyzer automatically set the Input Range to agree with the signal. Note that the Input Range readouts at the top of the screen are displayed in inverse when Auto Range is on.</p>
<p>5. Press [Display Setup]</p> <p>Press <Measurement></p> <p>Select (FFT ch2) with the knob and press [Enter].</p>	<p>Select the Display Setup menu.</p> <p>Change the Measurement of the active display (A).</p> <p>Choose FFT spectrum of Ch2 for the measurement in DisplayA (top). Both displays are independently measuring the filter output spectrum.</p>
<p>6. Press [Freq]</p>	<p>Select the Frequency menu. The menu shows the frequency parameters for the measurement in DisplayA (active display).</p>

1-16 Linking (Advanced Operation)

Press 	Highlight the Span. Note that the Link indicator at the top of the screen turns on. This indicates that the highlighted parameter (Span) is linked to both displays. Changing a linked parameter affects both displays at once.
Use the knob to adjust the Span to 12.8 kHz and press [Enter].	Narrow the Span of both displays to show the filter notch at 1 kHz (noisy of course).
Press again.	Highlight the Span again.
Press [Link]	Pressing [Link] toggles parameter linking off. The Link indicator now shows 'DispA' indicating that this menu box adjusts the span for DisplayA only.
Use the knob to adjust the Span to 3.2 kHz and press [Enter].	Change the Span of DisplayA to 3.2 kHz. The Span of DisplayB remains at 12.8 kHz. The SR780 allows the two displays to have differing Spans and Start frequencies. Many parameters affect the displays separately. Linking is a convenient way to adjust the two displays together and keep their settings the same. The default settings link many measurement parameters, such as frequency and averaging, together as found in many other instruments.
7. Press [Average]	Select the Average menu.
Press <Averaging>	Averaging is linked by default.
Select (On) with the knob and press [Enter].	Turn Averaging On for both displays.
Press <# Avgs>	Change the Number Of Averages for DisplayA.
Press [Link]	Unlink the Number Of Averages. 'DispA' is shown as the Link indicator.
Press [2] [0] and press [Enter].	Change the Number Of Averages for DisplayA to 20 (instead of 2). DisplayA will average for 10 times as many measurements as DisplayB and be quite a bit smoother.
8. Press [Active Display]	Let's change the Window for DisplayB. Make DisplayB the active display.
Press [Window]	Select the Window menu.

<p>Press <Window></p> <p>Press [Link]</p> <p>Select (Hanning) with the knob and press [Enter].</p>	<p>The windows are linked by default.</p> <p>Unlink the Window type. ‘DispB’ is shown as the Link indicator.</p> <p>DisplayB is now using the Hanning window while DisplayA is still using the BMH window.</p> <p>So far we have unlinked measurement parameters. Frequency Span, Averaging and Window type affect the actual measurements within the displays. Most analyzers do not allow these measurement parameters to be unlinked.</p> <p>Display parameters, such as Scaling, Views, Units and Marker functions, are usually unlinked. However, linking them can be a convenient way to adjust graph parameters together with a minimum of key presses.</p>
<p>9. Press [Display Setup]</p> <p>Press <Units></p> <p>Press [Link]</p> <p>Select (dBVrms) with the knob and press [Enter].</p>	<p>Select the Display Setup menu.</p> <p>Let’s change the Units for both displays.</p> <p>Link the Units parameter (default is unlinked).</p> <p>Both displays’ Units become dBVrms with a single parameter entry. The Units remain linked until unlinked with the [Link] key.</p>
<p>10. Press <Y Max></p> <p>Press [Link]</p> <p>Press [-] [1] [0] and press [Enter].</p> <p>Press [Auto Scale A]</p> <p>Press [Link] and then [Auto Scale A]</p>	<p>Let’s change the Top Reference of the graphs.</p> <p>Link the Y Max parameter (default is unlinked).</p> <p>Change the Top Reference of both graphs to -10 dBVrms with a single entry.</p> <p>Change the scale of DisplayA to center the data.</p> <p>Another simple way to adjust the scales of both graphs is using the Auto Scale keys.</p> <p>Pressing [Link] [Auto Scale A] first auto scales DisplayA and then changes the scale of DisplayB to match. This is convenient when you are comparing the two displays.</p>

1-18 Linking (Advanced Operation)

<p>11. Press [Link] and use the knob to move the Marker. Both Markers move together when linked.</p> <p>Press [Enter]</p> <p>Press [Marker Min]</p> <p>Press [Link] then [Marker Min]</p>	<p>The [Link] key temporarily links the two display Markers together.</p> <p>Pressing any key removes the link between the Markers.</p> <p>To permanently link the markers, go to the Marker menu and change <Marker> to Link.</p> <p>[Marker Min] moves the Marker in the active display (B) to the graph minimum.</p> <p>Pressing [Link] first moves both Markers to their graph minimums at the same time.</p> <p>[Link] preceding a function key generally performs the function on both displays at once. [Link] [Auto Scale] matches the active display. [Span Up] and [Span Down] are always linked.</p>
	<p>This concludes this measurement example. You should have a feeling for linking and unlinking and the flexibility of unlinked measurements.</p>

Triggering and the Time Record

This example investigates the trigger and time record. You will need a function generator capable of providing a 100 μ s wide pulse at 256 Hz with an amplitude of 1V. The output should have a DC level of 0V.

Make sure you have read ‘The FFT Time Record’ in Chapter 2 before trying this exercise.

<p>1. Press [System]</p> <p>Press <Preset></p> <p>Press [Enter] to confirm Preset.</p>	<p>Display the System menu.</p> <p>Preset returns the unit to its default settings.</p> <p>Preset requires confirmation to prevent accidental reset. Wait until the self tests are completed.</p>
<p>2. Turn on the generator and choose a pulsed output waveform. Set the frequency to 256 Hz, the pulse width to 100 μs and the amplitude to 1V. (These settings only need to be approximate.) Make sure that the DC level of the output is near 0V.</p> <p>Connect the generator output to the Ch1 A input of the analyzer.</p>	<p>The input impedance of the analyzer is 1 MΩ. The generator may require a terminator. Many generators have either a 50 Ω or 600 Ω output impedance. Use the appropriate feedthrough termination if necessary. In general, not using a terminator means that the output amplitude will not agree with the generator setting.</p>
<p>3. Press [Input]</p> <p>Press <Ch1 Input Range></p> <p>Press [4] [Enter]</p>	<p>Select the Input menu.</p> <p>Choose an input range that doesn't overload.</p> <p>Set the input range to 4 dBV (1.6V). Adjust the pulse amplitude to that no overloads occur.</p>
<p>4. Press [Active Display]</p> <p>Press [Display Setup]</p> <p>Press <Measurement></p> <p>Select (Time1) with the knob and press [Enter].</p>	<p>Let's change the Measurement for DisplayB. Make DisplayB the active display.</p> <p>Select the Display Setup menu.</p> <p>Change the Measurement of the active display (B).</p> <p>Choose Time Record of Ch1 for the measurement in DisplayB (bottom).</p>
<p>5. Press [Trigger]</p> <p>Press <Trigger Mode></p>	<p>Select the Trigger menu.</p> <p>Change the Trigger Mode.</p>

1-20 Triggering and the Time Record

Select (Auto Arm) with the knob and press [Enter].	Free Run means the measurement is free running (requires no trigger). Auto Arm means the trigger is armed automatically and the measurement is triggered.
Press <Trigger Level>	The default Trigger Source is the Ch1 input (our pulse signal). Adjust the trigger level to trigger on the pulse.
Press [3] [0] and [Enter].	Set the trigger level as a percentage of full scale. Adjust the level for a stable time record in DisplayB.
Press [Auto Scale B]	DisplayB (bottom) should display the pulse waveform at the left edge. Remember, the FFT span is baseband so the time record is entirely real and non-heterodyned. In this case, the display shows the signal pulse as a digital oscilloscope would.
<hr/>	
6. Press [Window]	Select the Window menu.
	Because the pulse is much shorter than the time record, we need to use the Uniform (or Force) window. The other window functions taper to zero at the start and end of the time record. Always be aware of the effect windowing has on the time record and the FFT.
Press <Window>	Select a new window type for both displays (window type is linked by default).
Select (Uniform) with the knob and press [Enter].	Notice how the spectrum in DisplayA is changed by the Uniform window.
Press [Auto Scale A]	The spectrum in DisplayA is the $\sin x/x$ envelope of a rectangular pulse. The zeroes in the spectrum occur at the harmonics of 1/pulse width (1/100 μ s or 10 kHz.)
<hr/>	
7. Press <Window>	Choose a non-optimum window.
Select (Hanning) with the knob and press [Enter].	Choose the Hanning window. Notice how the spectrum in DisplayA goes away.
Press [Display Setup]	Select the Display Setup menu.
Press <Measurement>	Change the Measurement of DisplayB to show the effect of the Hanning window on the time record.

<p>Select (WinTime1) with the knob and press [Enter].</p>	<p>The Hanning window is zero at the beginning of the time record and large in the center. This effectively zeroes the signal pulse at the start of the time record leaving nothing in the windowed time record. The FFT operates on this windowed time record and thus the spectrum shows no evidence of the signal pulse.</p>
<p>8. Press [Trigger]</p>	<p>Select the Trigger menu again.</p>
<p>Press <DelayB></p>	<p>Change the Trigger Delay for the measurement in DisplayB.</p>
<p>Press [-] [5] [0] [0] and [Enter].</p>	<p>We can get the spectrum back by delaying the time record relative to the trigger so that the pulse is positioned in the center of the time record.</p>
<p>Press [Auto Scale B]</p>	<p>A negative delay means that the time record starts before the trigger event. In this case, the time record is 1024 points long so we need about 500 bins (points) of negative delay to put the signal pulse in the center of the triggered time record.</p> <p>The trigger delay is specified in time record bins at the current span.</p>
<p>Press <DelayA></p>	<p>Note that the windowed time record in DisplayB shows the signal at the center of the time record.</p> <p>The amplitude of the windowed time record is not the same as the amplitude of the time record itself. This is because the window functions have gain and attenuation at different parts of the time record. The Hanning window is 2.0 at the center so the amplitude of the signal in the windowed time record is twice as large.</p> <p>The Hanning, Flattop, BMH and Kaiser windows are not intended for use with narrow pulse signals. They are used for signals which last the entire time record and normalized as such.</p> <p>The Uniform (and Force) windows have no gain and should be used with pulsed signals such as this.</p>
<p>Press <DelayA></p>	<p>We need to change the trigger delay for DisplayA in order to recover the spectrum.</p>

1-22 Triggering and the Time Record

Press [-] [5] [0] [0] and [Enter].	Use the same delay.
Press [Auto Scale A]	The windowed spectrum is shown in DisplayA.
9. Press [Display Setup]	Select the Display Setup menu.
Press <Measurement>	Change the Measurement of DisplayB back to Time Record.
Select (Time1) with the knob and press [Enter].	Time1 is the un-windowed time record.
Press [Window]	Select the Window menu.
Press <Window>	Change the window type for both displays.
Select (Uniform) with the knob and press [Enter].	Use the Uniform window (which is the correct window for this measurement).
10. Press [Trigger]	Select the Trigger menu.
Press <Trigger Mode>	Change the Trigger Mode.
Select (Free Run) with the knob and press [Enter].	Free Run requires no trigger. The measurements are not triggered. If the generator is set to 256 Hz pulse rate, the signal will drift slowly in the time record. This is because the SR780 time records are exactly 1/256 Hz (3.90625 ms) long (400 lines at full span) and the analyzer is running in real time (no missed data). The drift in the time record is because the analyzer and the generator are using different time bases.
Adjust the generator frequency to 255 Hz.	The time record is now unstable and the pulse moves through the entire time record. The spectrum in DisplayA is mostly unaffected since the Uniform window allows the pulse to be anywhere in the time record. Only when the pulse is not entirely within the time record is the spectrum disturbed.
	This concludes this measurement example. You should have a feeling for triggered time records and the effect of windowing on the resulting FFT.

Octave Analysis

This example investigates the test filter (enclosed with this manual) using Octave measurements. You will use the SR780 source to provide a broad band source and both displays to measure the output of the device under test.

Refer to ‘Octave Analysis’ in Chapter 2 for more about Octave Analysis measurements.

<p>1. Press [System]</p> <p>Press <Preset></p> <p>Press [Enter] to confirm Preset.</p>	<p>Display the System menu.</p> <p>Preset returns the unit to its default settings.</p> <p>Preset requires confirmation to prevent accidental reset. Wait until the self tests are completed.</p>
<p>2. Use a BNC Tee to connect the Source Output to the filter input and the Ch1 A Input.</p> <p>Connect the filter output to the Ch2 A Input.</p>	<p>Ch1 measures the source (filter input) and Ch2 measures the filter output.</p>
<p>3. Press [Display Setup]</p> <p>Press <Measure Group></p> <p>Select (Octave) with the knob and press [Enter].</p> <p>Press [Link] [Auto Scale A]</p>	<p>Select the Display Setup menu.</p> <p>Change the Measurement Group.</p> <p>Choose the Octave group. Both displays are now making Octave Analysis measurements.</p> <p>Auto Scale DisplayA and change the scale of DisplayB to match DisplayA.</p> <p>The Octave measurement displays the output of logarithmically spaced bandpass filters. This is not an FFT based measurement. The last bin at the right is a Sound Level measurement and may be calculated independently from the octave bands.</p> <p>Note that even though the source is a single frequency sine wave, the octave display shows a very broad peak. This is because the individual bandpass filters are very broad, 1/3 of an octave in this case.</p>
<p>4. Press [Source]</p> <p>Press <Noise></p>	<p>Select the Source menu.</p> <p>Choose Noise as the source type. Octave measurements are generally used to measure noise.</p>

1-26 Octave Analysis

Press <Type>	Change the type of noise.
Use the knob to select (Pink) and press [Enter].	Choose Pink noise. Pink noise rolls off at -3dB per octave. This maintains equal power per octave band and yields a flat octave spectrum.
Press [Auto Range Ch1] and [Auto Range Ch2].	Adjust the input ranges to remove overloads. Notice that the measurement needs to settle after the input range is changed. This is because the measurement is invalid until the input change has propagated through all of the octave band filters. This settling time is related to 1/bandwidth of each filter. Bands which are un-settled are graphed in half intensity. 'Settle' is displayed until all bands in the display are settled.
Press [Auto Scale A] and [Auto Scale B].	DisplayA (Ch1) shows the flat source spectrum and DisplayB (Ch2) shows the notch filter output.
5. Press [Average]	Select the Average menu. Note that this menu is changed in Octave group.
Press <Integration Time>	The Integration Time is the averaging time constant. All Octave measurements are rms averaged.
Press [1], select (s) with the knob, and press [Enter].	Increase the Integration Time to smooth the fluctuations in the spectrum.
6. Press [Freq]	Select the Frequency menu.
Press <Octave Resolution>	Change the number of bands per octave.
Use the knob to select (Full) and press [Enter].	Choose Full octave bands. Each band represents a full octave with very poor frequency resolution.
Press <Octave Resolution>	Change the number of bands per octave again.

<p>Use the knob to select (Twelfth) and press [Enter].</p>	<p>Choose 1/12 octave bands.</p> <p>Each band represents 1/12 of an octave with very good frequency resolution.</p> <p>Note that the measurement requires a long settling time. Narrow bands increases the settling time (1/bandwidth).</p> <p>Choosing narrow bands also increases the number of calculations required and decreases the maximum frequency which can be measured.</p>
<p>7. Press <Octave Resolution></p> <p>Use the knob to select (Third) and press [Enter].</p> <p>Press <Highest Band></p> <p>Use the knob to select 20 kHz and press [Enter].</p> <p>Press <Octave Channels></p> <p>Use the knob to select (1 Channel) and press [Enter].</p> <p>Press <Highest Band></p> <p>Use the knob to select 40 kHz and press [Enter].</p>	<p>Change the number of bands per octave again.</p> <p>Let's return to 1/3 octaves.</p> <p>Change the highest measured band.</p> <p>Remember, changing the octave resolution has lowered the highest band in the measurement.</p> <p>Set the highest band to 20 kHz.</p> <p>This is the highest allowed band for 2 channel, 1/3 octave analysis.</p> <p>We can change the number of channels which are being measured.</p> <p>Choose single channel octave analysis. In this case, both displays will always have the same input, resolution, frequency range and averaging.</p> <p>They can differ in their display related parameters, such as view and scaling.</p> <p>Change the highest measured band.</p> <p>Single channel analysis has twice the measurement bandwidth of two channel analysis. Thus, to increase the highest measured band, use 1 channel analysis.</p> <p>Set the highest band to 40 kHz.</p> <p>This is the highest allowed band for 1 channel, 1/3 octave analysis.</p>

Capture

This example investigates the Capture buffer using FFT measurements. You will use the SR780 to capture a signal and then analyze it from memory.

<p>1. Press [System]</p> <p>Press <Preset></p> <p>Press [Enter] to confirm Preset.</p>	<p>Display the System menu.</p> <p>Preset returns the unit to its default settings.</p> <p>Preset requires confirmation to prevent accidental reset. Wait until the self tests are completed.</p>
<p>2. Connect the Source Output to the Channel 1 A Input.</p>	<p>Setup to analyze the source output.</p>
<p>3. Press [Source]</p> <p>Press <Sine></p> <p>Press <Frequency 1></p> <p>Press [1] [.] [0] [2] [4] select (kHz) with the knob and press [Enter].</p>	<p>Select the Source menu.</p> <p>Choose Sine output.</p> <p>Adjust the output Frequency.</p> <p>Enter 1.024 kHz for the Frequency. Enter the value with the numeric entry keys. Select the units with the knob. Enter the new value with the [Enter] key.</p>
<p>4. Press [Capture]</p> <p>Press <Allocate Memory></p> <p>Press <Waterfall Memory></p> <p>Press [0] and [Enter].</p> <p>Press <Capture Memory></p>	<p>Select the Capture menu.</p> <p>The data memory is allocated between Capture, Waterfall and Arbitrary Waveform storage.</p> <p>Memory is allocated in blocks. Each block can store 2 kPoints. The total number of blocks available is displayed in the <Total Available> menu box. This number is for display only, it cannot be changed from the menu.</p> <p>Larger memory options (up to 4000 blocks) are available.</p> <p>To increase Capture memory, you must first decrease the other allocations so that the sum never exceeds the total available memory.</p> <p>Decrease the Waterfall allocation to 0.</p> <p>Select the Capture allocation.</p>

1-30 Capture

Press [9] [9] [0] and [Enter].	Increase it to 990 blocks. (2,027,520 points).
Press <Confirm Allocation> and <Return>.	You must confirm the new allocation. Changing the memory allocation destroys previously stored data in the memory.
5. Press <Capture Channels>	Select which inputs to capture.
Use the knob to select (Ch1) and press [Enter].	Choose Ch1 only. In this case, the entire capture buffer is available for Ch1. When both channels are captured, half of the buffer is available for each channel.
Press <Capture Length>	Increase the capture length.
Press [1] [9] [8] [0] and [Enter].	All of the capture allocation (990 blocks) is available. Each block stores 2 kPoints for a total of 1980 kPoints.
6. Press [Start Capture]	Start the capture. The buffer will take 7.73 seconds to fill. Since the Capture Mode is 1-Shot, the capture stops once the buffer is full. During this time, Capture indicator is highlighted and the Capture Progress indicator shows how much of the buffer has been filled (up to 100%).
Press [Active Display]	After capture is complete, the Capture indicator shows 'Cap Data' indicating that the Capture buffer contains data.
Press [Display Setup]	Make DisplayB (bottom) the active display.
Press <Measurement>	Select the Display Setup menu.
Use the knob to select (Capture1) and press [Enter].	Change the measurement of DisplayB.
Press <Zoom>	Choose Capture1 to show the contents of the Ch1 Capture buffer.
	There are far too many points in the buffer to graph each one. The graph shows the envelope of the data in this case.
	Zoom in to show individual points. 'Expand' below the graph indicates that the graph has been graphically zoomed and does not show all of the data along the X axis.

<p>Press [1] [1] and [Enter].</p>	<p>Enter a zoom factor of 11 (2^{11}). The display now shows the signal sine wave clearly.</p>
<p>7. Unplug the signal from the Ch1 input.</p> <p>Press [Input]</p> <p>Press <Input Source></p> <p>Use the knob to select (Playback) and press [Enter].</p> <p>Press <Playback Length></p> <p>Press [1] [9] [8] [0] and [Enter].</p> <p>Press <Playback Mode></p> <p>Use the knob to select (1-Shot) and press [Enter].</p>	<p>The signal should disappear from the spectrum in DisplayA.</p> <p>Select the Input menu.</p> <p>Change the Input Source to measure from the Capture buffer.</p> <p>Choose Playback instead of the analog inputs.</p> <p>The measurement now takes its input from the data stored in the Ch1 Capture buffer. The signal reappears in the spectrum in DisplayA.</p> <p>Only single channel measurements using Ch1 are allowed in this case (there is no Ch2 data available).</p> <p>You can choose to playback only a portion of the buffer if desired.</p> <p>Choose the entire buffer by setting the Playback Length equal to the Capture Length.</p> <p>Playback can be 1-Shot (once through the buffer and stop) or Circular (repeat when finished).</p> <p>Choose 1-Shot.</p> <p>Playback stops when the end of the buffer is reached. The Playback Progress indicator shows the current position within the buffer during playback.</p> <p>DisplayB automatically pans to show the portion of the Capture buffer at the current playback position.</p>
<p>8. Use a BNC TEE to connect the source to both Ch1 and Ch2 A inputs.</p> <p>Press [Input]</p> <p>Press <Input Source></p> <p>Use the knob to select (Analog) and press [Enter].</p>	<p>Reconnect the analog signal to both Ch1 and Ch2 inputs.</p> <p>Select the Input menu.</p> <p>Change the Input Source.</p> <p>Choose Analog input again. The Capture parameters can not be modified while the measurement input is Playback.</p>

1-32 Capture

Press [Display Setup]	Select the Display Setup menu.
Press <Measurement>	Change the Measurement for DisplayB.
Use the knob to select (FFT ch2) and press [Enter].	Measure the Ch2 input also.
<hr/>	
9. Press [Capture]	Select the Capture menu.
Press <Capture Channels>	Change which channels are captured.
Use the knob to select (Ch1+Ch2) and press [Enter].	Choose both channels. The Capture Length is automatically halved to accommodate both channels in the allocated memory.
Press <Sampling Rate>	We can increase the capture time by decreasing the Sampling Rate. This decreases the bandwidth of the stored signal.
Use the knob to decrease the rate to 131.1 kHz and press [Enter].	Choose 131.1 kHz as the Sampling Rate. The capture bandwidth is now 51.2 kHz (reduced from 102.4 kHz). During playback from this buffer, the measurement bandwidth will not be allowed to exceed 51.2 kHz.
Press [Start Capture]	Capture both inputs for 7.73 seconds. Watch for the Capture Progress indicator to reach 100%.
<hr/>	
10. Disconnect the signal from both inputs.	The signal should disappear from the spectrum in both displays.
Press [Input]	Select the Input menu.
Press <Input Source>	Change the Input Source.
Use the knob to select (Playback) and press [Enter].	Choose Playback from Capture. Since there is captured data for both inputs, both displays start measuring from the capture.
Press [Auto Scale A] and [Auto Scale B].	Scale the displays to show the measurements.

<p>Press [Start/Reset]</p>	<p>Start playback from the beginning of the buffer. Since the default Playback Speed is Normal, the entire playback takes as long as the equivalent real time measurement. In this case, the capture represents 7.73 seconds of data so the playback takes 7.73 seconds as well.</p> <p>At the current span (51.2 kHz), there are almost 1000 time records of captured data. Not all time records are displayed during Normal playback though all time records contribute to averaged measurements. The display is updated 8 times a second for 7.73 seconds for a total of 62 updates during this playback.</p> <p>Normal playback is limited to the real time limitations of the equivalent real time analog input measurement.</p>
<p>Press <Playback Speed></p>	<p>Change the Playback Speed.</p>
<p>Use the knob to select (Every Time Rec) and press [Enter].</p>	<p>Choose Every Time Record. Since the data is stored in memory, we can choose to display every stored time record.</p>
<p>Press [Start/Reset]</p>	<p>Start the playback at the beginning of the buffer.</p> <p>In this case, all 1000 time records are measured AND displayed. The display still updates at 8 Hz so playback takes about 125 seconds to complete.</p> <p>If the time records are overlapped, there may be more than 1000 measurements to display and playback will take even longer.</p> <p>Every Time Record playback is not limited by real time considerations.</p>
<p>11. Press [Freq]</p>	<p>Select the Frequency menu.</p>
<p>Press </p>	<p>Change the measurement span. The span can not be increased above 51.2 kHz since the captured data is bandwidth limited to 51.2 kHz (because of our capture sampling rate).</p>

1-34 Capture

Use the knob to select (6.4 kHz) and press [Enter].	Change the span to 6.4 kHz.
Press [Start/Reset]	Capture playback allows the same captured data to be measured at different spans, windows, averaging, etc. This is useful if the signal is hard to reproduce or occurs infrequently. At this span, the capture buffer only holds 124 time records and takes only 16 seconds to playback every time record.
12. Press [Input]	Select the Input menu.
Press <Playback Length>	It is generally a good idea to playback an exact number of time records. This way, the last record doesn't wrap around and use points from the start of the buffer. At this span (with no overlap), each time record is 62.5 ms long. The capture sampling rate was 131.1 kHz so 2 kPoints of capture represents 15.625 ms of data. Thus each time record is 8 kPoints of capture long. We want the Playback Length to be an integer multiple of 8 kPoints. 123 time records uses 984 kPoints and is close to the full capture length.
Press [9] [8] [4] and [Enter].	Change the Playback Length to an exact number of time records.
Press [Start/Reset]	Start the playback again.
	This concludes this example. Capture and Playback is a way to record a signal and re-analyze it over and over.

Waterfall Display

This example demonstrates the use of waterfall displays. Waterfalls are available for FFT and Octave measurements for analog inputs as well as capture playback.

In this example, we will simulate a reverberation measurement measuring the SR780 source. To perform a real measurement, you would use the source to drive a power amplifier and a microphone to receive the signal.

<p>1. Press [System]</p> <p>Press <Preset></p> <p>Press [Enter] to confirm Preset.</p>	<p>Display the System menu.</p> <p>Preset returns the unit to its default settings.</p> <p>Preset requires confirmation to prevent accidental reset. Wait until the self tests are completed.</p>
<p>2. Connect the Source Output to the Channel 1 A Input.</p>	<p>Setup to analyze the source output.</p>
<p>3. Press [Display Setup]</p> <p>Press <Measure Group></p> <p>Select (Octave) with the knob and press [Enter].</p>	<p>Select the Display Setup menu.</p> <p>Change the Measurement Group.</p> <p>Choose the Octave group. Both displays are now making Octave Analysis measurements.</p>
<p>4. Press [Freq]</p> <p>Press <Lowest Band></p> <p>Use the knob to select (50 Hz) and press [Enter].</p>	<p>Select the Frequency menu.</p> <p>Change the lowest band in the display.</p> <p>Select 50 Hz as the lowest band. The lowest band places a limitation on the minimum integration time. Raising this lowest band allows shorter integration times.</p>
<p>5. Press [Source]</p> <p>Press <Noise></p> <p>Press <Type></p> <p>Use the knob to select (Pink) and press [Enter].</p> <p>Press <Burst></p>	<p>Select the Source menu.</p> <p>Choose Noise as the source type. Octave measurements are generally used to measure noise.</p> <p>Change the type of noise.</p> <p>Choose Pink noise. Pink noise rolls off at -3dB per octave. This maintains equal power per octave band and yields a flat octave spectrum.</p> <p>Change the Burst percentage.</p>

1-36 Waterfall Display

Press [9] [6] [Enter]

Using a percentage less than 100% makes the noise source a triggered source. 100% burst outputs noise continuously with 100% duty cycle. Bursts less than 100% will output noise with less than 100% duty cycle and may be triggered.

In this case, the noise will be output for 96% of the source period (100 ms default) or 96 ms.

If the measurement is Free Run (or Source triggered), then the output is noise for 96 ms out of every 100 ms.

If the measurement is externally or manually triggered, the output is 96 ms every trigger with the minimum trigger period equal to 100 ms (the source period).

6. Press [Average]

Select the Average menu. Note that this menu is changed in Octave group.

Press <Averaging Type>

Change the Averaging Type.

Use the knob to select (Linear Time) and press [Enter].

Use Linear Time for best time resolution. Exponential Time averaging takes about 5 integration times to fully respond to a transient. Linear Time averaging responds in a single integration time.

Press <Integration Time>

Change the Integration Time.

Use the knob to select (8 ms) and press [Enter].

Choose the minimum time for the best resolution.

Press <Linear Avg Mode>

Change the Linear Average Mode. This determines how measurements behave when triggering is enabled (not Free Run).

Use the knob to select (Continuous) and press [Enter].

Choose Continuous. This means that a new measurement is started as soon as the previous average is complete. In this case, a new measurement is made every 8 ms, regardless of triggering.

If we choose Triggered, then a measurement is made only when triggered.

Press <Power Bin>

Change the Power Bin.

<p>Use the knob to select (L) and press [Enter].</p>	<p>Choose L (L_{eq}) as the sound level bin. L_{eq} is a standard broad band sound measurement. The result is displayed as the last bin in the display and is labeled 'L'.</p>
<p>7. Press [Trigger]</p> <p>Press <Trigger Mode></p> <p>Use the knob to select (Auto Arm) and press [Enter].</p> <p>Press <Trigger Source></p> <p>Use the knob to select (Manual) and press [Enter].</p> <p>Press <Trigd Source Mode></p> <p>Use the knob to select (One Shot) and press [Enter].</p>	<p>Select the Trigger menu.</p> <p>Change the Trigger Mode.</p> <p>Choose Auto Arm. We want to trigger the noise burst and the start of our measurements with a trigger.</p> <p>Change the Trigger Source.</p> <p>Choose Manual trigger. We will start our measurement with a button press. We could also use an external trigger. Triggering on the signal itself requires the use of an external signal source.</p> <p>Change the Triggered Source Mode. This determines whether the source triggers only once (on the first trigger after [Start/Reset]) or on every trigger.</p> <p>Choose One Shot to trigger the noise burst only once at the start of the measurement.</p>
<p>8. Press [Start/Reset]</p> <p>Press <Manual Trigger></p> <p>Press [System]</p> <p>Press <Preferences></p>	<p>[Start/Reset] starts the measurement. Since the measurement is triggered (not Free Run), nothing happens until the first trigger is received.</p> <p><Manual Trigger> supplies the first trigger. The source outputs a single noise burst (Trigd Source Mode=One Shot). The display starts a continuous stream of octave measurements, each linear averaged for 8 ms and each starting when the previous average is complete (Linear Avg Mode=Continuous).</p> <p>Since the source only outputs noise for 96 ms, the rise and fall of the measurement goes by very quickly.</p> <p>Select the System menu.</p> <p>Select the user Preferences menu.</p>

1-38 Waterfall Display

Press <Done Volume>	Change the 'Done' alarm volume. This is the beep that occurs when a linear average or measurement is done.
Use the knob to select (Quiet) and press [Enter].	Choose Quiet to turn off this alarm.
Press [Trigger]	Go back to the Trigger menu.
Press [Start/Reset] and <Manual Trigger>.	Try it again. It isn't possible to make any determination of the transient response to the noise burst in real time. We need to store the measurements taken 8 ms apart in the waterfall buffer.
<hr/>	
9. Press [Waterfall]	Select the Waterfall menu.
Press <Display>	Change the Display.
Use the knob to select (Waterfall) and press [Enter].	Choose Waterfall display. This shows measurements scrolling down. Without waterfall storage, this is purely graphical, no data can be read from measurements other than the most recent.
Press <Storage>	Select waterfall Storage.
Use the knob to select (One Shot) and press [Enter].	Choose One Shot to fill the waterfall buffer once and stop.
Press <Total Count>	Change the number of measurements to store in the waterfall buffer.
Press [5] [0] [Enter]	The Total Count is linked to both displays by default. Entering 50 changes the total count for both displays to 50.
<hr/>	
10. Press [Trigger]	Select the Trigger menu again.
Press [Start/Reset]	[Start/Reset] starts the measurement. Since the measurement is triggered (not Free Run), nothing happens until the first trigger is received.

<p>Press <Manual Trigger></p>	<p><Manual Trigger> supplies the first trigger. The source outputs a single noise burst (Trigd Source Mode=One Shot). The display starts a continuous stream of octave measurements, each linear averaged for 8 ms and each starting when the previous average is complete (Linear Avg Mode=Continuous).</p> <p>50 averaged measurements are stored in the waterfall buffer starting with the trigger. The first 96 ms (12 measurements) are during the triggered noise burst. The remaining measurements are taken after the noise burst turns off and measure the decay response or reverberation.</p> <p>The number of records stored in the waterfall is shown in the Vertical Scale Bar as 'wf 50'.</p>
<p>11.Press [Alt] and turn the knob clockwise.</p> <p>Continue until the display does not scroll any further.</p> <p>Press [Alt]</p> <p>Turn the knob clockwise to move the marker along the frequency axis of a single record.</p> <p>Move the marker all the way to the right hand edge of the display. The marker position should read 'L:49'.</p>	<p>[Alt] knob moves the marker in the Z direction (time axis) in the waterfall display. This scrolls the display to show earlier measurement record.</p> <p>When the keypad and knob are in the alternate mode, the alternate key functions (labeled below each key) are in effect.</p> <p>The waterfall records are numbered starting with 0 (the most recent measurement) in the back. In this case, we stored 50 records so the earliest record is number 49.</p> <p>The marker Z position is displayed next to the marker frequency in the Marker Position Bar above the graph. It should read '49' when you have scrolled all the way to the beginning of the buffer.</p> <p>Notice how the first few records show the spectrum growing at the start of the noise burst.</p> <p>Pressing [Alt] removes the keypad and knob from the alternate mode.</p> <p>The normal knob function moves the marker along the X axis of a single record.</p> <p>The last bin in the octave display is the total sound level L_{eq} (as selected by <Power Bin>).</p>

1-40 Waterfall Display

<p>12. Press [Waterfall]</p> <p>Press <More></p> <p>Press <Slice to Trace>, select (Trace 1) with the knob and press [Enter].</p> <p>Press [Active Display]</p> <p>Press [Alt] [Help/Local], select (Trace 1) with the knob and press [Enter].</p> <p>Press [Auto Scale B]</p> <p>Use the knob to move the marker around in the waterfall slice (DisplayB).</p>	<p>Select the Waterfall menu.</p> <p>Show More of the Waterfall menu.</p> <p>A waterfall slice is the time history of a single X axis location (data at the marker X position from all stored records). The slice data is stored in a trace.</p> <p>Make the bottom display active (DisplayB).</p> <p>Trace to Display is an alternate function. The alternate key functions are labeled below each key (in this case, the [Help/Local] key).</p> <p>Trace to Display recalls trace data to the active display.</p> <p>Auto Scale DisplayB to show the time history of L_{eq}.</p> <p>The points in a slice are numbered and displayed from 0 (oldest) to 49 (newest). Note that this differs from the waterfall display in which the newest record is numbered 0. This is because the slice is a time record with time advancing to the right and it is more natural to number it this way.</p> <p>Note that the first 12 records (96 ms) show a large value for L_{eq} during the noise burst. If this was a real reverberation measurement, the signal would not decay in a single 8 ms measurement but would last for a reverberation time.</p>
<p>13. Press [Active Display]</p> <p>Press [Waterfall]</p> <p>Press <View Count></p> <p>Press [5] [0] [Enter].</p> <p>Press <Marker Z to></p> <p>Press [0] [Enter].</p> <p>Press <Angle></p> <p>Use the knob to select (45°) and press [Enter].</p>	<p>Make the top display active (DisplayA).</p> <p>Select the Waterfall menu.</p> <p>Change the View Count. This is the number of records which are displayed.</p> <p>Enter 50 to show the entire waterfall buffer.</p> <p>Move the marker to a specific record number.</p> <p>Enter record 0 (most recent at the back).</p> <p>Change the skew angle of the display.</p> <p>Choose 45° to skew the opposite way.</p>

Press <More>

Show More of the Waterfall menu.

Press <Paused Drawing>

Change the waterfall direction.

Use the knob to select (Oldest at Top) and press [Enter].

While the measurement is running, the newest records are added at the top of the waterfall display. When the measurement is done or paused, the waterfall may be drawn with either the newest (Normal) or Oldest at Top.

Since this measurement is measuring a transient decay, it is better to draw the oldest record at the top and the subsequent (smaller amplitude) records in the front.

This concludes this example. There are many display parameters in the Waterfall menu which you should familiarize yourself with.

The transient response of any FFT or Octave measurement may be recorded in a waterfall buffer. Using a slice will give a time evolution of a single X axis bin.

Swept Sine Measurement

This example investigates the test filter (enclosed with this manual) using Swept Sine measurements. You will use the SR780 source to provide a sweeping sine source and both inputs to measure the input to and output from the device under test.

<p>1. Press [System]</p> <p>Press <Preset></p> <p>Press [Enter] to confirm Preset.</p>	<p>Display the System menu.</p> <p>Preset returns the unit to its default settings.</p> <p>Preset requires confirmation to prevent accidental reset. Wait until the self tests are completed.</p>
<p>2. Use a BNC Tee to connect the Source Output to the filter input and the Ch1 A Input.</p> <p>Connect the filter output to the Ch2 A Input.</p> <p>Press [Input]</p> <p>Press <Ch1 Input Range></p> <p>Press [2] and [Enter].</p>	<p>In this instrument, transfer function is defined as Ch2 response over Ch1 reference. Thus, Ch1 monitors the filter input (source output) and Ch2 measures the response of the device under test.</p> <p>Select the Input menu.</p> <p>Adjust the Ch1 input range.</p> <p>Set the range to 2 dBV.</p>
<p>3. Press [Display Setup]</p> <p>Press <Measurements Group></p> <p>Select (Swept Sine) with the knob and press [Enter].</p>	<p>Select the Display Setup menu.</p> <p>There are three Measurement Groups - FFT, Octave and Swept Sine. The Measurement Group determines which Measurements are available to the displays.</p> <p>Choose the Swept Sine group. The menus now configure swept sine measurements only.</p>
<p>4. Press [Freq]</p> <p>Press <Start></p> <p>Press [9] [0] [0] select (Hz) with the knob and press [Enter].</p> <p>Press <Stop></p> <p>Press [1] [.] [1] select (kHz) with the knob and press [Enter].</p>	<p>Select the Frequency menu.</p> <p>Adjust the sweep Start Frequency.</p> <p>Enter 900 Hz.</p> <p>Adjust the sweep Stop Frequency.</p> <p>Enter 1.1 kHz.</p> <p>The 900 - 1100 Hz sweep covers the filter region of interest.</p>

1-44 Swept Sine Measurement

Press <# of Points>	Adjust the Number Of Points in the sweep.
Press [1] [0] [2] [4] [Enter].	Enter 1024 points.
5. Press [Start/Reset]	Reset and start the sweep. The source is a sine wave whose frequency sweeps from 900 Hz to 1.1 kHz stopping at 1024 discrete frequencies. At each frequency point, the inputs are measured and displayed.
Wait for the sweep to complete at least once.	The small triangular marker moving across the bottom of the graphs indicates the position of the sweep in progress.
Press [Auto Scale A] and [Auto Scale B]	Scale the two displays. The top display is the filter input (source output) and should be fairly flat. The bottom display is the filter output and show the filter notch at 1 kHz.
6. Press [Display Setup]	Select the Display Setup menu.
Press <Measurement>	Change the Measurement of DisplayA (active display).
Select (Transfer Function) with the knob and press [Enter].	Choose Transfer Function (filter output divided by filter input).
Press <Units>	Transfer function is unitless. Change the display units.
Select (dB) with the knob and press [Enter].	Choose dB.
Press [Display Options]	Select the Display Options menu.
Press <Format>	Change the Display Format.
Select (Single) with the knob and press [Enter].	Choose a Single Display with DisplayA (Transfer Function) active.
Press [Auto Scale A]	Scale the display to show the Transfer Function.
7. Press [Marker]	Select the Marker menu.
Press <Width>	Change the Marker Region width.
Select (Normal) with the knob and press [Enter].	Choose Normal Width (1/2 division).
Press <Seeks>	Change the Marker Seeks function.

<p>Select (Min) with the knob and press [Enter].</p> <p>Press [Marker Min]</p>	<p>Seek the Minimum data within the Marker Region.</p> <p>Move the Marker to the notch minimum. Read the notch depth and frequency in the marker Position display.</p>
<p>8. Press [Average]</p> <p>Press <Integration Time></p> <p>Press [4] [0] select (ms) with the knob and press [Enter].</p>	<p>Select the Average menu.</p> <p>Change the Integration Time.</p> <p>Enter 40 ms. The Integration Time is set in increments of 3.9 ms so the entry is rounded to 39 ms.</p> <p>The new estimated sweep time is displayed below the graph.</p> <p>At each frequency point, the inputs measure the amount of signal at the source frequency. This is done by multiplying the input data by the source sine (and cosine) and averaging the results over an integration time. The actual integration time is always rounded up to an exact number of cycles of the source frequency. This rejects signals which are at different frequencies, such as noise and harmonics. Long integration times improve signal to noise while increasing the measurement time.</p> <p>The greater of the Integration Cycles and Integration Time (rounded to the next complete cycle) is used at each frequency. The sweep is at 1 kHz so each cycle is 1 ms. Setting the Integration Time to 40 ms increases the integration time.</p>
<p>9.</p> <p>Press [Auto Range Ch1] and [Auto Range Ch2]</p>	<p>So far, the Input Ranges, Source Level and Sweep Resolution have been constant over the sweep. Let's change these to optimize both the measurement and the measurement time.</p> <p>Change both inputs to Auto Range (the Input Range indicators at the top of the screen are highlighted).</p>

Press [Input]	When Auto Range is on, the Input Range is optimized at each frequency point in the sweep. If the signal is overloaded, the range moves up. If the signal is below half scale, the range moves down. This optimizes the input signal to noise at each point separately and can dramatically improve the S/N of measurements with a large dynamic range. Measurements in excess of 140 dB of dynamic range are possible with swept sine.
Press <Ch2 Coupling>	This notch filter is only -60 dB deep and does not actually require Auto Range for a clean measurement. Note that the Ch2 Input Range changes as the sweep moves through the notch, following the filter output signal.
Select (AC) with the knob and press [Enter].	Auto Range increases the sweep time. Select the Input menu. Change the Input Coupling for Ch2. Choose AC coupling. This eliminates the DC offset from the source and allows Auto Range on Ch2 to cover the entire allowable input range.
10. Press [Freq]	Select the Frequency menu.
Press <Auto Resolution>	Change the Auto Resolution mode.
Select (On) with the knob and press [Enter].	Choose Auto Resolution on. If successive points differ by less than the Faster Threshold (on both Ch1 and Ch2), then the sweep starts to skip points. Each successive time this threshold is met, the number of points skipped is increased until the Max # of Skips is reached. This speeds up the sweep in regions where the response is slowly changing. If successive points differ by more than the Slower Threshold (on either input), then the sweep returns to the earlier point and continues with no skipping. This 'fills' in the region where the response is rapidly changing. The sweep continues from this point, speeding up when allowed and slowing down when required.

	<p>Note that the sweep progress marker at the bottom of the graph changes speed through the notch.</p> <p>Auto Resolution greatly shortens the measurement time while preserving the resolution where required.</p>
<p>11. Press [Source]</p> <p>Press <Auto Level Ref></p> <p>Select (Channel 2) with the knob and press [Enter].</p> <p>Press <Ideal Ref></p> <p>Press [1] [0], select (mV) with the knob, and press [Enter].</p> <p>Press [Active Display]</p> <p>Press [Auto Scale B]</p>	<p>Select the Source menu.</p> <p>Change the Auto Level Reference.</p> <p>Choose Channel 2 as the Auto Level Reference.</p> <p>Change the Ideal Reference level.</p> <p>Enter 10 mV.</p> <p>Auto Level will try to maintain the Ch2 signal level at the Ideal Reference level by changing the source level at each point of the sweep. The Max Source sets the largest source output allowed.</p> <p>This is useful whenever the transfer function has substantial gain as well as attenuation or if a test requires a constant level within the device under test (usually input or output). In this case, Auto Level is not really required but illustrates its use.</p> <p>Change the active display to DisplayB (which is still measuring the spectrum of Ch2).</p> <p>Scale the display. On both sides of the notch, you can see Auto Level keeping the Ch2 signal level at 10 mV (-40 dBV). The reference tolerance is 3 dB and is set by the Ref Limits. As the sweep moves into the notch, the source level reaches the Max Source level of 1 V and the Ch2 signal drops to -60 dBV. The spectrum of Ch1 measures the actual source level at each point and the Transfer Function is still calculated correctly.</p>
<p>12. Press [Active Display]</p>	<p>Switch back to DisplayA (Transfer Function).</p>

1-48 Swept Sine Measurement

	<p>This concludes this measurement example. You should have a basic understanding of Swept Sine measurements. The Input Range, Resolution and Source Level optimizations greatly extend the dynamic range of the measurement while minimizing the measurement times.</p>
--	--

Saving and Recalling

This example illustrates saving and recalling displays to reference displays, traces and disk files.

<p>1. Press [System]</p> <p>Press <Preset></p> <p>Press [Enter] to confirm Preset.</p>	<p>Display the System menu.</p> <p>Preset returns the unit to its default settings.</p> <p>Preset requires confirmation to prevent accidental reset. Wait until the self tests are completed.</p>
<p>2. Connect the Source Output to the Channel 1 A Input.</p> <p>Press [Span Down] twice to change the span to 25.6 kHz.</p> <p>Press [Auto Scale A]</p>	<p>Setup to analyze the source output. The default source is a 10.24 kHz sine.</p> <p>Narrow the span to display the signal better.</p> <p>Scale the display to show the entire measurement range.</p>
<p>3. Press [Display Ref]</p> <p>Press [Input]</p> <p>Press <Ch1 Input Range></p> <p>Press [3] [0] and [Enter].</p>	<p>Copy the current measurement data into the reference graph for the active display (A).</p> <p>The reference graph is stored data which is associated with each display. The reference graph is shown in half intensity.</p> <p>We need to change the measurement data in order to see the reference graph since it is 'underneath' the current data.</p> <p>Select the Input menu.</p> <p>Change the input range to raise the noise floor.</p> <p>Select 30 dBV for the Ch1 Input Range.</p> <p>Now you can see the reference graph below the current measurement's noise floor. The reference graph allows visual comparison of live data with stored data. The marker can also be set to read the current data relative to the reference graph.</p> <p>The reference graph can be loaded by copying the current live data or by copying a stored trace.</p>

1-50 Saving and Recalling

<p>4. Press [Display Setup]</p> <p>Press <Ymax></p> <p>Press [8] [0] and [Enter].</p> <p>Press [Alt] [Start Capture]</p> <p>Press [Display Ref]</p> <p>Press [Auto Scale A]</p>	<p>Select the Display Setup menu.</p> <p>Change the top reference for the graph.</p> <p>Set the top reference to 80 dBV.</p> <p>Note that the live data is graphed with the new vertical reference but the reference graph did not move. This allows the reference graph to be offset from the live data (so it is visible).</p> <p>Snap Ref is an alternate function. The alternate key functions are labeled below each key (in this case, the [Start Capture] key).</p> <p>Snap Ref redraws the reference graph with the current display scaling.</p> <p>Pressing [Display Ref] again turns off the reference graph. The reference graph data is lost.</p> <p>To save the reference graph, transfer the reference graph to a trace before turning it off. The trace may be saved to disk.</p> <p>Scale the graph appropriately again.</p>
<p>5. Press [Alt] [Print Screen]</p> <p>Use the knob to select Trace 3 and press [Enter].</p> <p>Press [Span Up] twice to return to full span.</p> <p>Press [Active Display]</p> <p>Press [Alt] [Help/Local]</p>	<p>Display to Trace is an alternate function. This function saves the current data in the active display to a trace.</p> <p>Store the display in Trace 3.</p> <p>There are 5 traces available for data storage. They can store the results of any measurement (other than capture buffer). They can be viewed as complex arrays of data which can be viewed like any other measurement data.</p> <p>Change the live measurement.</p> <p>Make DisplayB (bottom) active.</p> <p>Trace to Display is an alternate function. This function recalls trace data to the active display.</p>

<p>Press [Enter] to select Trace 3.</p>	<p>Only Trace 3 contains data at this time. Only Trace 3 may be selected.</p>
<p>Press [Display Setup]</p>	<p>DisplayB now shows the data stored in Trace 3. The display is labeled 'Off-Line' (in its upper left corner) indicating that it is showing static data.</p>
<p>Press [Display Setup]</p>	<p>Select the Display Setup menu.</p> <p>Note that the Measurement Group and Measurement menu boxes are shown in gray. This indicates that these parameters may not be changed for the active display. In this case, the active display contains stored data so the measurement parameters cannot be changed.</p>
<p>Press <Ymax></p>	<p>Other measurement parameters, such as averaging and window type, are also not allowed to be changed when the active display is Off-Line.</p>
<p>Press <Ymax></p>	<p>Change the graph scale of DisplayB.</p> <p>The view and scale of DisplayB can be changed of course. These parameters simply change the way the stored data is graphed.</p>
<p>Press [8] [0] and [Enter].</p>	<p>Move the graph down.</p>
<p>Press [Active Display]</p>	<p>Make DisplayA (top) the active display. Note that the Measurement Group and Measurement menu boxes are not gray. This is because these parameters may be adjusted for the live measurement in DisplayA.</p>
<p>Press [Active Display]</p>	<p>Make DisplayB (bottom) the active display again.</p>
<p>Press [Display Options]</p>	<p>Select the Display Options menu.</p>
<p>Press <Display></p>	<p>Make DisplayB live again.</p>
<p>Use the knob to select (Live) and press [Enter].</p>	<p>Choose Live to return the live measurement to DisplayB.</p>
<p>6. Put a blank 1.44MB, 3.5" disk into the disk drive.</p>	<p>Let's save DisplayA to a disk file.</p> <p>Use a blank disk if possible, otherwise any disk that you don't mind formatting will do. Make sure the write protect tab is off.</p>

1-52 Saving and Recalling

Press [Disk]	Select the Disk menu.
Press <Disk Upkeep>	Choose the Disk Upkeep menu. Make sure that the disk does not contain any information that you want!
Press <Format Floppy> and press [Enter] to confirm.	This function requires a confirmation. Go ahead and confirm. Formatting takes about a minute.
Press <Return>	Go back to the main Disk menu.
<hr/>	
7. Press [Active Display]	Make DisplayA (top) the active display again. We are going to save DisplayA to disk.
Press <File Name>	We need a file name.
Press [Alt]	[Alt] lets you enter the letter characters printed below each key. The number and backspace keys function normally. 'ALT' is highlighted (at the top of the screen) when the Alternate keys are in use.
Press [D] [A] [T] [A] [1] [Enter]	Enter a file name (any legal DOS file name up to 8 characters). Pressing [Enter] terminates the entry and removes the [Alt].
Press <Display to Disk>	Save the measurement data in DisplayA to disk using the specified file name. The extension .78D is appended automatically.
Press <File Name>	Enter another file name.
Press [D] [A] [T] [A] [2] [Enter]	Use a new file name to make another file.
Press <Display to Disk>	Save the measurement again.
<hr/>	
8. Press [Active Display]	Make DisplayB (bottom) the active display.
Press <File Name>	To recall a file, first specify the file name. You can either enter the name or select from the file catalog.
Turn the knob to display the file catalog.	Turning the knob while <File Name> is highlighted displays the file catalog of the current directory.

<p>Use the knob to select one of the disk files and press [Enter].</p> <p>Press <Disk to Display></p>	<p>The knob selects a file and scrolls the display. Only the files with the appropriate extension (.78D) are shown. To show all files (*.*), press [Exp].</p> <p>Recall the data in the file to the active display (DisplayB).</p> <p>Once again, DisplayB is 'Off-Line' indicating that it is showing static data.</p>
<p>9. Press [Display Options]</p> <p>Press <Display></p> <p>Use the knob to select (Live) and press [Enter].</p>	<p>Select the Display Options menu.</p> <p>Make DisplayB live again.</p> <p>Choose Live to return the live measurement to DisplayB.</p>
	<p>This concludes this example. Remember, 'Off-Line' displays are showing stored data, not live measurement results. Many measurement parameters can not be adjusted for an 'Off-Line' display.</p>

User Math Functions

This example measures the group delay of the test filter (enclosed with this manual) using User Math Functions. You will use the SR780 source to provide a broad band source and both displays to measure the output of the device under test.

<p>1. Press [System]</p> <p>Press <Preset></p> <p>Press [Enter] to confirm Preset.</p>	<p>Display the System menu.</p> <p>Preset returns the unit to its default settings.</p> <p>Preset requires confirmation to prevent accidental reset. Wait until the self tests are completed.</p>
<p>2. Use a BNC Tee to connect the Source Output to the filter input and the Ch1 A Input.</p> <p>Connect the filter output to the Ch2 A Input.</p>	<p>In this instrument, transfer function is defined as Ch2 response over Ch1 reference. Thus, Ch1 monitors the filter input (source output) and Ch2 measures the response of the device under test.</p>
<p>3. Press [Source]</p> <p>Press <Chirp></p> <p>Press [Window]</p> <p>Press <Window></p> <p>Select (Uniform) with the knob and press [Enter].</p>	<p>Select the Source menu.</p> <p>Choose Chirp output. The output is an equal amplitude sine wave at each frequency bin of the FFT spectrum.</p> <p>Select the Window menu.</p> <p>Adjust the FFT Window function.</p> <p>The Chirp source requires the use of the Uniform window since not all chirp frequency components are present at all points in the time record. The chirp is exactly periodic with the FFT time record and does not 'leak' with the uniform window.</p>
<p>4. Press [Auto Range Ch1]</p> <p>Press [Auto Range Ch2]</p>	<p>Let the analyzer automatically set the Input Ranges to agree with the signals. Note that the Input Range readouts at the top of the screen are displayed in inverse when Auto Range is on.</p>
<p>5. Press [Freq]</p> <p>Press </p> <p>Use the knob to adjust the Span to 6.4 kHz and press [Enter].</p>	<p>Select the Frequency menu.</p> <p>Adjust the FFT Span.</p> <p>Set the Span to display the filter notch at 1 kHz.</p>

	<p>The top display (A) is measuring the filter input and should show a fairly flat spectrum. The bottom display (B) is measuring the filter output and should show a deep notch.</p> <p>Both displays are measuring absolute signal levels.</p>
6. Press [User Math]	Select the User Math menu.
Press <Function>	Choose one of the five user functions available in the FFT measurement group.
Use the knob to select (FFTUsrFn2) and press [Enter].	Select Function2 to edit.
Press <Edit Fn>	Show the Edit Function menu.
Press <Operands>	<p>The display shows the available operands for this function.</p> <p>Use <Operands> and <Operations> to switch the display between operands and operators.</p> <p>Use the knob to highlight the desired box and press [Enter] to insert the selection into the function string at the top of the screen.</p>
Use the knob to highlight FFT(2) and press [Enter].	<p>Choose FFT(2) as the first operand. This is the FFT of Ch2 and is identical to the normal measurement. We are going to define a transfer function (FFT2/FFT1).</p> <p>As soon as the operand is entered, the display switches to show operations.</p>
Use the knob to highlight / (divide) and press [Enter].	<p>Choose the divide operations next.</p> <p>The display switches back to operands.</p> <p>You can choose another operation instead by pressing <Operations>.</p>
Use the knob to highlight FFT(1) and press [Enter].	Choose FFT(1) as the denominator of the transfer function.
Press <Function String>	This key moves the marker to the function string at the top of the screen. This allows you to delete terms and insert new ones.

<p>Use the knob to move the insertion point to the beginning of the function (highlight FFT2).</p> <p>Press <Operations></p> <p>Use the knob to highlight GrpDly and press [Enter].</p> <p>Press <Enter Eq.></p>	<p>Move to the start of the string by highlighting the first term (FFT2).</p> <p>‘Ins’ above the function string indicates that new terms will be inserted before the highlighted term. ‘Rep’ indicates that the new term replaces the highlighted one. Use <Insert/Replace> to toggle between insert and replace.</p> <p>Insert the Group Delay operator in front of the transfer function.</p> <p>Closing parentheses are not required (if they are at the very end of the string).</p> <p>Enter the equation.</p>
<p>7. Press [Display Setup]</p> <p>Press <Measurement></p> <p>Use the knob to select (FFTUsrFn2) and press [Enter].</p> <p>Press <View></p> <p>Use the knob to select (Real Part) and press [Enter].</p> <p>Press [Auto Scale A]</p>	<p>Select the Display Setup menu.</p> <p>Change the measurement of the active display (DisplayA).</p> <p>Choose FFT User Function2.</p> <p>Change the view. Group delay is the derivative of the phase with respect to ω and is a real time.</p> <p>Choose Real Part. The units automatically switch to linear units.</p> <p>User Functions are dimensionless quantities. You can choose dB (logarithmic) or units (linear).</p> <p>Scale the display.</p> <p>The group delay is the delay time caused by the filter at different frequencies. The data values are seconds of delay. Most points are in the neighborhood of 10 to 600 μs.</p> <p>At the 1 kHz notch, the group delay has a singularity. Remember, the notch filter has a phase discontinuity at the notch frequency.</p>

1-58 User Math Functions

<p>8. Press [Display Options]</p> <p>Press <d/dx Window></p> <p>Press [.] [1] [Enter]</p> <p>Press [2] [Enter]</p>	<p>Select the Display Options menu.</p> <p>The group delay is the derivative of the phase. The derivative operation requires an aperture or window.</p> <p>Set the window to 0.1% of the display length. This increases the resolution (makes things narrower) of the graph while decreasing the smoothing of noisy data.</p> <p>Set the window to 2%. This decreases the resolution (makes thing wider) while increasing the smoothing of noisy data.</p>
	<p>This concludes this example. User Functions allow you to define your own measurements starting with the basic SR780 measurements. User Functions can also use stored trace data (for calibrations and normalizations) and user constants.</p>

Limit Testing

This example is intended to familiarize the user with limit testing. Limit Testing tests the measurement data against a set of defined Limit Segments. When measurement data exceeds a Limit Segment at any point, the test fails. Each display has its own set of Limit Segments.

A Limit Segment is defined as the line between the pair of points (X0,Y0) and (X1,Y1). The segment values between the endpoints are calculated for the displayed span. A segment may be defined as either an Upper or Lower limit. Measurement data which is greater than an Upper limit or less than a Lower limit cause the test to fail.

<p>1. Press [System]</p> <p>Press <Preset></p> <p>Press [Enter] to confirm Preset.</p>	<p>Display the System menu.</p> <p>Preset returns the unit to its default settings.</p> <p>Preset requires confirmation to prevent accidental reset. Wait until the self tests are completed.</p>
<p>2. Connect the Source Output to the Channel 1 A Input.</p> <p>Press [Auto Scale A]</p>	<p>Setup to analyze the source output. The default source is a 10.24 kHz sine.</p> <p>Scale the display to show all of the data.</p>
<p>3. Press [Analysis]</p> <p>Press <Limit Test></p> <p>Press <Edit Limits></p> <p>Press <New Segment></p> <p>Press <X0></p> <p>Press [8] [0] [0] [0] [Enter]</p>	<p>Select the Analysis menu.</p> <p>Choose Limit Test.</p> <p>Show the Edit Limits menu. We can't turn on any testing until limits are defined.</p> <p>This function adds a new segment. The new segment has a default position and length.</p> <p>The segment is defined by its endpoints, (X0,Y0) and (X1,Y1). These values are specified for the current view and units, in this case, Hz for the x values and dBVpk for the y values.</p> <p>The segments are drawn in half intensity. The arrow markers at the end points point down for upper limits and point up for lower limits. The current segment (whose endpoints are shown and edited in the menu) has two additional arrows at the endpoints.</p> <p>Select X0 first.</p> <p>Enter a value of 8000 Hz.</p>

1-60 Limit Testing

Press <Y0>	Select Y0.
Press [-] [1] [0] [Enter]	Enter a value of -10 dBVpk.
Press <X1>	Select X1.
Press [1] [2] [0] [0] [0] [Enter]	Enter a value of 12000 Hz.
Press <Y1>	Select Y1.
Press [-] [1] [0] [Enter]	Enter a value of -10 dBVpk. The segment should intersect the signal peak at 10.24 kHz.
Press <Return>	Return to the Limit Test menu.
<hr/>	
4. Press <Limit Testing>	Select Limit Testing.
Use the knob to select (On) and press [Enter].	Turn Limit Testing on. The limit test result is displayed to the left of the graph. In this case 'Fail' should be shown. The limit that we drew is an upper limit. Since the data peak exceed this limit, the test fails.
Press <Edit Limits>	Go back to the Edit Limits menu.
Press <Shift All>	Select Shift All limit segments. This moves all of the segments together. In this case, there is only one segment.
Press [7] [Enter]	Enter 7 to move the segment up by 7 dBVpk. The new segment is above the signal peak and the limit test passes.
<hr/>	
5. Press <New Segment>	Add another segment.
Press <X0>	Select X0 first.
Press [2] [0] [0] [0] [0] [Enter]	Enter a value of 20000 Hz.
Press <Y0>	Select Y0.
Press [-] [8] [0] [Enter]	Enter a value of -80 dBVpk.
Press <X1>	Select X1.

<p>Press [9] [0] [0] [0] [0] [Enter]</p> <p>Press <Y1></p> <p>Press [-] [8] [0] [Enter]</p>	<p>Enter a value of 90000 Hz.</p> <p>Select Y1.</p> <p>Enter a value of -80 dBVpk.</p> <p>The segment should be above the noise floor. The limit test should still pass.</p>
<p>6. Press <Segment#></p> <p>Press [0] [Enter]</p> <p>Press <Limit Type></p> <p>Use the knob to select (Lower) and press [Enter].</p> <p>Press <Return></p> <p>Press <Limit Beep></p> <p>Use the knob to select (On) and press [Enter].</p>	<p>Change the segment which we are editing. The current segment is identified in the order in which they are created.</p> <p>Select segment 0 (the first one). Before editing a segment, make sure that you have chosen the correct one. The current segment is identified in the display by two additional arrows at the endpoints and its endpoint coordinates are displayed in the menu.</p> <p>Select the Limit Type for segment 0.</p> <p>Change the limit to a lower limit.</p> <p>The limit test now fails since data falls below the segment.</p> <p>Return to the Limit Testing menu.</p> <p>Select Limit Beep.</p> <p>On enables the audible alarm. This alarm alerts you to limit test failures.</p>
<p>7. Press [Display Setup]</p> <p>Press <Measurement></p>	<p>Select the Display Setup menu.</p> <p>Change the Measurement.</p> <p>The limit segments are defined for the current measurement, view and units. Changing any of these parameters turns limit testing off.</p> <p>The Limit Testing and Beep are turned off since the limit segments we defined have no meaning for this measurement.</p>

1-62 Limit Testing

Use the knob to select (Time1) and press [Enter].	Change the Measurement to Time Record Ch1.
Press <Measurement>	If we went back to the Limit Testing menu and tried to edit limits now, the previous limit segments would be lost. Each display only has a single set of limits and they are defined for a specific measurement, view and units.
Use the knob to select (FFT ch1) and press [Enter].	Change the Measurement back.
8. Press [Analysis]	Select FFT ch1 again.
Press <Limit Test>	Select the Analysis menu.
Press <Limit Segments>	Go to the Limit Testing menu.
Use the knob to select (Show) and press [Enter].	Select Limit Segments.
	Show the segments. The two segments defined earlier are still available.
	This concludes this example. Limit testing is a powerful tool for repetitive tests. In an automated test environment, limit segments are usually downloaded from a host computer. The SR780 performs the limit testing in real-time and the results are queried by the host computer.

Exceedance Statistics

This example is intended to familiarize the user with calculating exceedance centile statistics (L_n). L_n is calculated from measurements stored in the waterfall buffer.

L_n is the amplitude at each bin which is exceeded by $n\%$ of the records in the waterfall. L_n is commonly used to characterize environmental noise levels.

<p>1. Press [System]</p> <p>Press <Preset></p> <p>Press [Enter] to confirm Preset.</p>	<p>Display the System menu.</p> <p>Preset returns the unit to its default settings.</p> <p>Preset requires confirmation to prevent accidental reset. Wait until the self tests are completed.</p>
<p>2. Connect the Source Output to the Channel 1 A Input.</p>	<p>Setup to analyze the source output.</p>
<p>3. Press [Display Setup]</p> <p>Press <Measure Group></p> <p>Select (Octave) with the knob and press [Enter].</p>	<p>Select the Display Setup menu.</p> <p>Change the Measurement Group.</p> <p>Choose the Octave group. Both displays are now making Octave Analysis measurements.</p>
<p>4. Press [Source]</p> <p>Press <Noise></p> <p>Press <Type></p> <p>Use the knob to select (Pink) and press [Enter].</p>	<p>Select the Source menu.</p> <p>Choose Noise as the source type. Octave measurements are generally used to measure noise.</p> <p>Change the type of noise.</p> <p>Choose Pink noise. Pink noise rolls off at -3dB per octave. This maintains equal power per octave band and yields a flat octave spectrum.</p>
<p>5. Press [Average]</p> <p>Press <Power Bin></p>	<p>Select the Average menu. Note that this menu is changed in Octave group.</p> <p>We will leave the averaging at its default, 100 ms exponential time.</p> <p>Change the Power Bin.</p>

1-64 Exceedance Statistics

Use the knob to select (L) and press [Enter].	Choose L (L_{eq}) as the sound level bin. L_{eq} is a standard broad band sound measurement. The result is displayed as the last bin in the display and is labeled 'L'.
Press [Auto Scale A]	Scale Display A to show the entire range of the data.
6. Press [Waterfall]	Select the Waterfall menu. L_n is calculated from measurements stored in the waterfall buffer.
Press <Storage>	Select waterfall Storage.
Use the knob to select (One Shot) and press [Enter].	Choose One Shot to fill the waterfall buffer once and stop.
Press <Total Count>	Change the number of measurements to store in the waterfall buffer.
Press [1] [0] [0] [Enter]	Enter the Total Count for both displays (100). The Storage Interval is 100 ms. A measurement snapshot is added to the waterfall buffer every Storage Interval so 100 measurements will take 10 s to complete.
Press [Start/Reset]	Start the measurement. This resets the waterfall buffer. New measurements are added to the waterfall buffer every 100 ms. The number of records stored in the waterfall is shown in the Vertical Scale Bar and increments to 100. Because the waterfall storage is One Shot, the waterfall buffer fills once (100 records). No more records are added after 10 seconds.
7. Press [Analysis]	Select the Analysis menu.
Press <Exceedance Stats>	Select the Exceedance Statistics menu.
Press <Stop Index>	The exceedance is calculated using the records in the waterfall buffer starting with the Start Index (0 is the most recent record) and continuing through the Stop Index (Total Count - 1).
Press [9] [9] [Enter].	Enter 99 to include records 0 through 99 (100 total).

<p>Press [Pause/Cont]</p> <p>Press <Calculate Excd>, choose (Trace 1) with the knob and press [Enter].</p>	<p>Pause the measurement. Exceedance calculation requires that the active display be paused. This ensures that the waterfall buffer is static and no new records will be added during the calculation.</p> <p>The exceedance results are stored in a data trace. The trace measurement is the same type as the waterfall measurements. In this case, the trace data for each bin is exceeded by only 1% (Exceedance Pct) of the records stored in the waterfall buffer.</p>
<p>8. Press [Alt] [Link], choose (Trace 1) with the knob and press [Enter].</p> <p>Press [Pause/Cont]</p>	<p>Trace to Ref is an alternate function. The alternate key functions are labeled below each key (in this case, the [Link] key).</p> <p>Trace to Ref copies the data in a trace to the reference graph of the active display. The reference graph is shown in half intensity.</p> <p>In this case, the reference graph is the level of each octave bin which is exceeded only 1% of the time (L_1).</p> <p>Note that the exceedance is also calculated for the power bin (L_{eq}).</p> <p>Continue the live measurement. Note that the live measurement data rarely exceeds the reference graph.</p>
<p>9. Press [Pause/Cont]</p> <p>Press <Exceedance Pct></p> <p>Press [9] [9] [Enter].</p> <p>Press <Calculate Excd>, choose (Trace 2) with the knob and press [Enter].</p> <p>Press [Alt] [Link], choose (Trace 2) with the knob and press [Enter].</p>	<p>Pause the live measurement again.</p> <p>Change the Exceedance Percentage.</p> <p>Enter 99%. This level is exceeded 99% of the time.</p> <p>The exceedance results are stored in Trace 2.</p> <p>Trace to Ref is an alternate function. The alternate key functions are labeled below each key (in this case, the [Link] key).</p> <p>Trace to Ref copies the data in a trace to the reference graph of the active display. The reference graph is shown in half intensity.</p> <p>In this case, the reference graph is the level of each octave bin which is exceeded 99% of the time (L_{99}).</p>

1-66 Exceedance Statistics

	<p>This concludes this example. Exceedance is a common measurement for environmental noise levels, such as airports or highways. Change the octave integration time and waterfall storage interval to optimize the measurement rate. Use a larger waterfall buffer (up to 2000 measurements per display) for long monitoring times.</p>
--	---

Chapter 2

Analyzer Basics

In This Chapter

Measurement Groups	2-3	Auto Correlation	2-16
What is an FFT?	2-4	Cross Correlation	2-17
Why Look At A Signal's Spectrum?	2-4	Capture Buffer	2-18
The FFT Analyzer	2-4	User Function	2-19
Advantages And Limitations	2-4	Views	2-20
FFT Frequency Spans	2-6	Log Magnitude	2-20
Full Span	2-6	Linear Magnitude	2-20
Spans Less Than Full Span	2-6	Magnitude ²	2-20
Baseband Spans	2-6	Real Part	2-20
Starting the Span Above DC	2-7	Imaginary Part	2-20
FFT Time Record	2-8	Phase	2-20
Baseband Time Records	2-8	Unwrapped Phase	2-21
Heterodyned Time Records	2-8	Nyquist Plot	2-21
The Time Record Display	2-9	Nichols Plot	2-22
Why Use The Time Record?	2-9	FFT Averaging	2-23
Watch Out For Windowing!	2-9	RMS Averaging	2-23
FFT Windowing	2-10	Vector Averaging	2-23
In The Frequency Domain	2-10	Peak Hold Averaging	2-24
Uniform	2-10	Linear Weighting	2-24
Hanning	2-11	Waterfall Storage	2-24
Flattop	2-11	Exponential Weighting	2-24
BMH	2-11	Real Time Bandwidth and Overlap	2-25
Kaiser	2-12	What is Real Time Bandwidth?	2-25
Force	2-12	Averaging Speed	2-25
Exponential	2-12	Overlap Processing	2-25
Force-Exponential	2-12	Time Record Increment	2-26
User Defined	2-13	Settling	2-26
FFT Measurements	2-14	Vector Averaging	2-27
FFT Spectrum	2-14	Triggering	2-27
Time Record	2-14	Waterfall Display	2-28
Windowed Time Record	2-15	What is a Waterfall?	2-28
Orbit	2-15	Waterfall Storage	2-28
Cross Spectrum	2-15	Waterfall Display	2-29
Transfer Function	2-15	Capture Buffer	2-30
<F2/F1>	2-15	Input Sampling	2-30
<F2>/<F1>	2-16	Capture Fill	2-30
Force-Exponential	2-16	Capture Playback	2-31
Coherence	2-16	Capture as the Arbitrary Source	2-32

2-2 Analyzer Basics

The Source	2-33	Trace Storage	2-48
Sine	2-33	User Math Functions	2-49
Two Tone	2-33	What is a User Function?	2-49
Chirp	2-33	Measurement Groups and Traces	2-49
Noise	2-33	Units	2-49
Arbitrary	2-33	Operands	2-50
Windowing	2-34	X Axis	2-50
Source Trigger	2-34	Operations	2-51
External Trigger	2-34	User Function Limits	2-52
Octave Analysis	2-35	Example Functions	2-53
What is Octave Analysis?	2-35	FFT Group	2-53
Band Center Frequencies	2-35	Octave Group	2-54
Full Octave Bands	2-35	Swept Sine Group	2-54
1/3 Octave Bands	2-35	Signal Inputs	2-55
1/12 Octave Bands	2-35	Manual Range	2-55
Octave Measurements	2-36	Auto Range	2-55
Octave	2-36	Input Noise	2-55
Capture	2-36	Input Impedance	2-56
User Function	2-37	Anti-aliasing Filter	2-56
Octave Averaging	2-37	A-Weighting Filter	2-57
Linear Time	2-37	Input Transducer Units	2-57
Exponential Time	2-37	Input Connections	2-58
Equal Confidence	2-38	Single-Ended Connection (A)	2-58
Peak Hold	2-38	Differential Connection (A-B)	2-58
Sound Level Measurement	2-38	Common Mode Signals	2-58
Leq	2-38	AC vs DC Coupling	2-59
Impulse	2-38	Intrinsic (Random) Noise Sources	2-60
Peak	2-39	Johnson Noise	2-60
Total Power	2-39	Shot Noise	2-60
Settling Time	2-40	1/f Noise	2-60
Swept Sine Measurements	2-41	Total Noise	2-60
Why Use Swept Sine?	2-41	External Noise Sources	2-61
Swept Sine Measurement Setup	2-42	Capacitive Coupling	2-61
Swept Sine Measurements	2-43	Inductive Coupling	2-62
Spectrum	2-43	Resistive Coupling (Ground Loops)	2-63
Cross Spectrum	2-43	Microphonics	2-63
Transfer Function	2-43	Thermocouple Effects	2-64
User Function	2-44		
Averaging - Settling and Integration	2-44		
Sweep Frequency and Auto Resolution	2-45		
Input Auto Ranging	2-46		
Source Auto Level and Ramping	2-46		

Measurement Groups

The SR780 is organized into three Measurement Groups - FFT, Octave Analysis and Swept Sine. Choose the Measurement Group in the [Display Setup] menu.

The Measurement Group determines how the input data is processed. In FFT group, the input data is gathered into time records which are then transformed into spectra. In Octave group, the data is passed through a parallel bank of filters and averaged. In Swept Sine group, the data is integrated over exact source cycles.

The data processing in each group is governed by the parameters chosen in the menus. For some menus, the choice of the Measurement Group determines which parameters are shown in the menu. The [Frequency], [Average] and [Source] menus have three different sets of parameters, one for each group. For other menus, part or all of the menu is unavailable in certain groups. The [Window], [Capture] and [Waterfall] parameters do not apply to all groups.

Each group has its own set of available measurements. All three have frequency domain measurements while only FFT has time records. To make a measurement, choose the Measurement Group, then the Measurement, View and Units.

What is an FFT?

An FFT analyzer takes a time varying input signal, as you would see on an oscilloscope trace, and computes its frequency spectrum. Fourier's basic theorem states that any waveform in the time domain can be represented by the weighted sum of pure sine waves of all frequencies. If the signal in the time domain is periodic, then its spectrum is probably dominated by a single frequency component. The spectrum analyzer represents the time domain signal by its component frequencies.

Why Look At A Signal's Spectrum?

For one thing, some measurements that are very hard in the time domain are very easy in the frequency domain. Take harmonic distortion. It is hard to quantify the distortion by looking at a good sine wave output from a function generator on an oscilloscope. When the same signal is displayed on a spectrum analyzer, the harmonic frequencies and amplitudes are displayed with amazing clarity. Another example is noise analysis. Looking at an amplifier's output noise on an oscilloscope basically measures just the total noise amplitude. On a spectrum analyzer, the noise as a function of frequency is displayed. It may be that the amplifier has a problem only over certain frequency ranges. In the time domain it would be very hard to tell.

Many of these types of measurements can be done using analog spectrum analyzers. In simple terms, an analog filter is used to isolate frequencies of interest. The filtered signal power is measured to determine the signal strength in certain frequency bands. By tuning the filters and repeating the measurements, a reasonable spectrum can be obtained.

The FFT Analyzer

An FFT spectrum analyzer works in an entirely different way. The input signal is digitized at a high sampling rate. Nyquist's theorem says that as long as the sampling rate is greater than twice the highest frequency component of the signal, then the sampled data will accurately represent the input signal (in the frequency domain). In the SR780, sampling occurs at 262 kHz. To make sure that Nyquist's theorem is satisfied, the input signal passes through an analog anti-aliasing filter that removes all frequency components above 102.4 kHz. The resulting digital time record is then mathematically transformed into a frequency spectrum using an algorithm known as the Fast Fourier Transform or FFT. The resulting spectrum shows the frequency components of the input signal.

The original digital time record comes from discrete samples taken at the sampling rate. The corresponding FFT yields a spectrum with discrete frequency samples or bins. In fact, the spectrum has half as many frequency bins as there are time points. (Remember Nyquist's theorem.) Suppose that you take 1024 samples at 262 kHz. It takes 3.9 ms to take this time record. The FFT of this record yields 512 frequency points, but over what frequency range? The highest frequency will be determined by the period of 2 time samples or 131 kHz. The lowest frequency is just the period of the entire record or $1/(3.9 \text{ ms})$ or 256 Hz. The output spectrum thus represents the frequency range from DC to 131 kHz with 512 points spaced every 256 Hz.

Advantages And Limitations

The advantage of this technique is its speed. The entire spectrum takes only 3.9 ms to measure. The limitation of this measurement is its resolution. Because the time record is

only 3.9 ms long, the frequency resolution is only 256 Hz. Suppose the signal has a frequency component at 380 Hz. The FFT spectrum will detect this signal but place part of it in the 256 Hz bin and part in the 512 Hz bin. One way to measure this signal accurately is to take a time record that is $1/380$ Hz or 3.846 ms long with 1024 evenly spaced samples. Then the signal would land all in one frequency bin. But this would require changing the sampling rate based upon the signal (which you haven't measured yet). This is not a practical solution. Instead, the way to measure the signal accurately is to lengthen the time record and change the span of the spectrum.

FFT Frequency Spans

Full Span

Full span is the widest frequency span corresponding to the fastest available sampling rate. In the SR780, this is DC to 131 kHz using a sampling rate of 262 kHz. Because the signal passes through an anti-aliasing filter at the input, the entire frequency span is not useable. The filter has a flat response from DC to 102.4 kHz and then rolls off steeply from 102.4 kHz to 156 kHz. The range between 102.4 kHz and 131 kHz is therefore not useable and the actual displayed frequency span stops at 102.4 kHz. There is also a frequency bin labeled 0 Hz (or DC). For a time record of 1024 samples (3.9 ms), this bin actually covers the range from 0 Hz to 128 Hz (the lowest measurable frequency) and contains the signal components whose period is longer than the time record (not only DC). So our final displayed spectrum contains 401 frequency bins. The first covers 0 - 128 Hz, the second 128 - 384 Hz, and the 401st covers 102.272 - 102.528 kHz.

Spans Less Than Full Span

The duration of the time record determines the resolution of the spectrum. What happens if we want a resolution better than 256 Hz? We need to increase the duration of the time record. There are two ways to do this - take more points in each time record or lower the sampling rate. Taking more points is difficult since both the memory and processing requirements increase with the number of points. The longest time record the SR780 can process is 2048 points (800 point FFT).

Instead, we take the approach of lowering the sample rate and making the same number of samples cover a longer time. If we halve the sample rate, this doubles the time record duration and gives us better resolution. However, the sample rate also determines the frequency span. By halving the sample rate, we also halve the frequency span. At a constant number of points in the FFT, we must tradeoff better resolution with narrower frequency spans.

Changing the sample rate of the A-D converter is not practical since that requires changing the analog anti-aliasing filter cutoff frequency. Instead, the incoming data samples (at 262 kHz) are digitally filtered and down-sampled. The advantage is that the digital filter's cutoff frequency can be easily changed. For example, to decrease the sampling rate from 262 kHz to 131 kHz, the incoming data is low-pass filtered to remove any signals above 51.2 kHz. This filter rolls off steeply from 51.2 kHz to 65.6 kHz. Since output of this filter only contains frequencies up to 65.6 kHz, Nyquist only requires a sample rate of 131 kHz and only every other point is kept as part of the time record. The result is a time record of 1024 points sampled at 131 kHz to make up an 7.8 ms record. The FFT processor operates on a constant number of points and the resulting FFT will yield 400 bins from DC to 51.2 kHz. The resolution or linewidth is 128 Hz (1/7.8 ms).

This process of halving the sample rate and span can be repeated by using multiple stages of digital filtering. The SR780 can process a 400 bin spectra with a span of only 195.3 MHz and a time record of 2048 seconds if you have the patience. However, this filtering process only yields baseband measurements (frequency spans which start at DC).

Baseband Spans

Some points to remember are:

1. The FFT resolution (number of frequency bins in the spectrum) determines the number of points required in the time record.
2. The duration of the time record determines the frequency resolution of the spectrum (spacing of frequency bins in the spectrum).
3. The sampling rate determines the frequency span of the spectrum (Nyquist's theorem). The sampling rate is the number of points in the time record divided by the duration of the time record.

The SR780 allows FFT resolutions of 100, 200, 400 or 800 bins (not counting DC). Changing the resolution does not change the span, instead the time record length is changed.

The various FFT resolutions are summarized below.

<u>FFT Resolution</u>	<u>Frequency Resolution</u>	<u>Time Record</u>
100 bins	Span/100	100/Span
200 bins	Span/200	200/Span
400 bins	Span/400	400/Span
800 bins	Span/800	800/Span

Starting the Span Above DC

Using digital filtering alone requires that every span start at DC. Frequency shifting is accomplished by heterodyning. Heterodyning is the process of multiplying the incoming signal by a sine (and cosine) wave. The resulting spectrum is shifted by the heterodyne frequency. If we incorporate heterodyning with our digital filtering, we can shift any frequency span so that it starts at DC. The resulting FFT yields a spectrum offset by the heterodyne frequency. When this spectrum is displayed, the frequencies of the X axis are the original frequencies of the signal.

Heterodyning allows the analyzer to compute zoomed spectra (spans that start at frequencies other than DC). The digital processor must filter and heterodyne the input in real time to provide the appropriate filtered and down-sampled time record at all spans and center frequencies.

FFT Time Record

The FFT operates on time records. A time record is simply a sequence of data samples. The duration of the time record is the FFT resolution/span. There are two types of time records, those corresponding to baseband spans (starting at DC) and those corresponding to zoomed spans (not starting at DC). Zoomed time records are heterodyned (frequency shifted) and do NOT contain the input signal at its original frequencies.

Baseband Time Records

Baseband time records are very simple to understand. They represent the input signal passed through low-pass filters. At full span, the signal has passed through the analog anti-aliasing filter. The sample rate is 262 kHz. To get the time records for narrower spans, the data is digitally filtered and down-sampled. At a given FFT resolution, each time the span is halved, the bandwidth of the time record is halved and the sampling rate is halved. The length of the time record (in seconds) doubles.

Heterodyned Time Records

Zoomed time records are more complicated. Heterodyning is a complex operation. The input points are multiplied by $\cos(\omega t)$ and $\sin(\omega t)$ to yield a real and an imaginary part. ω is 2π times the span center frequency. The real and imaginary parts of each point are orthogonal. You can think of the complex time record as two separate records, one real and one imaginary.

The input signal is frequency shifted or heterodyned. This moves signals at the span center to DC and frequencies below span center to negative frequencies. If the span center is at 51.2 kHz, the input range from 0 to 102.4 kHz is shifted to -51.2 kHz to +51.2 kHz. This data is then passed through a low-pass filter which cuts off at ± 51.2 kHz. This results in a ± 51.2 kHz (102.4 kHz) useable span centered at 51.2 kHz. The output data only requires a sampling rate of 131 kHz (instead of the original 262 kHz real input rate) so only every other point is saved. Thus, the original 102.4 kHz span is represented by a time record with half as many points and half the sampling rate and the same duration. How can this be?

The complex time record has half as many points as the baseband (real) time record with the same span and resolution. This is because the negative frequency part of the spectrum is kept in the heterodyned case. You can think of the real and imaginary parts of the complex time record as completely independent data streams, each at half of the original sample rate and each with half of the original span. Together, they represent the original span with the original number of samples and the original time record length.

Digital filtering and down-sampling is used to narrow the span of the heterodyned data. This 'zooms' in around the heterodyne frequency (span center). The first digital filter reduces the sample rate by 2 (to 131 kHz) but does not reduce the span.

The second digital filter cuts off at ± 25.6 kHz and reduces the sample rate by 2 again. The number of points in the time record is NOT halved again (this only happens at the first filter due to the splitting of the real time record into two parts, real and imaginary). The new time record must have twice the original duration and thus, half of the original span. This results in a 51.2 kHz (± 25.6 kHz) span centered at 51.2 kHz. The time record duration is twice the full span time record. The sample rate is 1/4 of the full span

baseband sample rate. In comparison, the baseband 0-51.2 kHz span has a sample rate 1/2 of the full span baseband sample rate. This is because the baseband time record is all real and the zoomed time record is complex.

Further filtering and down-sampling reduces the span even further. At each span, the zoomed time record is complex and has half as many points (half the sample rate) as the corresponding real baseband time record.

The Time Record Display

The baseband time record display resembles a digital oscilloscope display. Signals at frequencies above the span have been filtered out. The anti-aliasing filters (both analog and digital) have a steep but finite roll-off at their cutoff frequencies. Signals which are just above the cutoff frequency are outside of the FFT span (not in the displayed spectrum) but appear attenuated in the time record.

Baseband time records are entirely real, they have no imaginary part.

The zoomed time record display does not resemble the original data. The data has been frequency shifted. Signals at the center of the span appear at DC while frequencies at both edges of the span appear as high frequencies. The anti-aliasing filters have a steep but finite roll-off at their cutoff frequencies. Signals which are just outside of the span are not displayed in the FFT but appear frequency shifted and attenuated in the time record.

Zoomed time records are complex, they have both a real and an imaginary part. You can display the magnitude and phase as well as the real or imaginary part. The sampling rate is always half of the equivalent baseband span.

Why Use The Time Record?

The time record display can be useful in determining whether the time record is triggered properly. If the analyzer is triggered and the signal has a large component synchronous with the trigger, then the signal should appear stationary in the time record. If the signal triggers randomly, then the time display will jitter back and forth.

Remember, the time record has a resolution of $1/(\text{sample rate})$. A triggered time record will always jitter by 1 sample. This jitter is removed in the computation of the phase of the spectrum relative to the trigger.

Watch Out For Windowing!

The SR780 can display both the time record and the windowed time record. Most window functions taper off to zero at the start and end of the time record. If a transient signal occurs at the start of the time record, the corresponding windowed time record and FFT may not show anything because the window function reduces the transient to zero.

FFT Windowing

A signal which is not exactly periodic within the time record does not fall on an exact frequency bin of the FFT spectrum (integer multiple of the FFT frequency resolution). Its energy is split across multiple adjacent frequency bins. This is true but it's actually worse than that. An FFT spectrum models the time domain as if a time record repeated itself forever. This means the end of the time record is followed by the start of the time record in a circular fashion. If the data is not continuous across the stop to start boundary, the discontinuity will act like a delta function and actually 'leak' energy into all frequencies in the spectrum.

Windows are functions defined over a time record which are periodic in a circular time record. They generally start and end smoothly at zero and are smooth functions in between. When the time record is windowed, its data samples are multiplied by the window function, time point by time point, and the resulting windowed time record is definitely periodic in the circular sense. Windowing eliminates the leakage in the spectrum from signals not exactly periodic with the time record.

In The Frequency Domain

In the frequency domain, a window acts like a filter. The amplitude of each frequency bin is determined by centering this filter on each bin and measuring how much of the signal falls within the filter.

If the filter is narrow, then only frequencies near the exact bin frequency will contribute to the bin. A narrow filter is called a selective window - it selects a small range of frequencies around each bin. However, since the filter is narrow, frequencies slightly off bin are attenuated and phase shifted. Selective windows are useful for resolving adjacent peaks or improving signal to noise. They should not be used for accurate amplitude measurements (except for signals at exact bin frequencies).

If the filter is wide, then frequencies farther from each exact bin will contribute to the bin amplitude making the signal peaks very wide. However, off bin frequencies are not attenuated. These windows should be used for accurate amplitude measurements rather than good frequency resolution.

Windowing allows the FFT to accurately measure signals at frequencies which are not exact frequency bins. The different types of windows trade off selectivity, amplitude accuracy, and noise floor.

The SR780 offers many types of window functions - Uniform (no windowing), Flattop, Hanning, Blackman-Harris (BMH), Kaiser, Force and Exponential, and User Defined windows.

Uniform

The Uniform window is actually no window at all. The entire time record is used with equal weighting. A signal will appear in a single frequency bin in the spectrum if its frequency is exactly equal to a frequency bin. (It is exactly periodic within the time record). If its frequency is between bins, it will leak into every bin of the spectrum. These two cases also have a great deal of amplitude variation between them (up to 4 dB).

In general, this window is only useful when looking at transients which do not last the entire time record.

The Uniform window may also be used with signals which are exactly periodic in the time record such as a chirp or exact bin sine frequencies.

Hanning

The Hanning window is a commonly used window. However, it has an amplitude variation of about 1.5 dB for signals which are not at exact bin frequencies and provides only reasonable selectivity. Its side-lobes are very high and broad for off-bin frequencies. As a result, the Hanning window can limit the performance of the analyzer when looking at signals close together in frequency and very different in amplitude.

The Hanning window is most often used in noise measurements since it has the lowest noise floor.

The Hanning window function is

$$w_i = 1.0 - \cos\left(2\pi \frac{i}{N}\right) \text{ for } i = 0 \dots N-1 \text{ and } N = \text{number of time record points.}$$

Flattop

The Flattop window has the best amplitude accuracy of any window. The amplitude variation is only about 0.02 dB for signals between exact frequency bins. However, the selectivity is worse. Unlike the other windows, the Flattop window has a very wide pass band and very steep rolloff on either side. Thus, signals appear wide but do not leak across the whole spectrum.

The Flattop window is the best window to use for accurate amplitude measurements.

The Flattop window function is

$$w_i = 1.0 - 1.93 \cdot \cos\left(2\pi \frac{i}{N}\right) + 1.29 \cdot \cos\left(4\pi \frac{i}{N}\right) - 0.388 \cdot \cos\left(6\pi \frac{i}{N}\right) + 0.028 \cdot \cos\left(8\pi \frac{i}{N}\right)$$

for $i = 0 \dots N-1$ and $N = \text{number of time record points.}$

BMH

The BMH window combines good selectivity and reasonable accuracy (about 0.8 dB for signals between exact frequency bins). The BMH window has much lower side-lobes than the Hanning window and very little broadening of non-bin frequencies.

The BMH window is a good window to use for measurements requiring a large dynamic range.

The BMH window function is

$$w_i = 1.0 - 1.36109 \cdot \cos\left(2\pi \frac{i}{N}\right) + 0.39381 \cdot \cos\left(4\pi \frac{i}{N}\right) - 0.032557 \cdot \cos\left(6\pi \frac{i}{N}\right)$$

2-12 FFT Windowing

for $i = 0 \dots N-1$ and $N =$ number of time record points.

Kaiser

The Kaiser window combines excellent selectivity and reasonable accuracy (about 0.8 dB for signals between exact frequency bins). The Kaiser window has the lowest side-lobes and least broadening for non-bin frequencies. This makes this window the best for selectivity.

The Kaiser window is the best window to use for measurements requiring a large dynamic range.

$$w_i = \frac{I_0 \left[\pi \cdot \alpha \cdot \sqrt{1 - \left(\frac{i - \frac{N}{2}}{\left(\frac{N}{2} \right)} \right)^2} \right]}{I_0(\pi \cdot \alpha)} \text{ for } i = 0 \dots N-1 \text{ and } N = \text{number of time record points.}$$

$\alpha = 0.1R/\pi$, $R = 120.0$ and I_0 is the modified Bessel function of the first kind.

Force

The Force window is uniform over the beginning of the time record and zero over the remainder. The force length is user specified. This window is used to isolate impulsive signals, such as impact excitations, from noise and other oscillations later in the time record.

The signal must be zero at the start of the time record in order to be continuous with the end of the time record to prevent broadband leakage in the spectrum.

Exponential

The Exponential window attenuates the time record with a decaying exponential time constant. This window is often used in impact testing on the response channel to remove oscillations which last longer than the time record.

The signal should be zero at the start of the time record in order to be continuous with the end of the time record to prevent broadband leakage in the spectrum.

Force-Exponential

Many impact measurements require the Force window for one channel and the Exponential window for the other channel. Use User Math to define a 2 channel measurement using different windows for each input channel. For example, to measure a transfer function with a force window on Ch1 (impulse) and an exponential window on Ch2 (response), define a user function as $\text{FFTa}(2)/\text{FFTa}(1)$. In this case, the FFT of Ch2 uses the window of DisplayB and the FFT of Ch1 uses the window of DisplayA, regardless of which display is showing the function. Simply un-link the [Window]<Window> entry and assign the Force window to DisplayA and the Exponential window to DisplayB.

User Defined

The User window is any function that the user provides. The User window is copied from a stored trace using <Trace to Window>. The trace may contain display data or be loaded from disk or via the computer interface.

<Trace to Window> automatically changes the window of the active display to the User window. <Trace to Window> is the only way to choose the User window. The User window is lost if the window type is changed. To switch back and forth between a User window and another window, keep using <Trace to Window>.

Remember, window functions have a great deal of impact on the resulting FFT spectrum. A poorly designed window can result in significant measurement errors.

FFT Measurements

FFT Spectrum

The FFT spectrum is the basic measurement of an FFT analyzer. It is simply the FFT of a time record. The FFT spectrum is a complex quantity (it contains phase as well as amplitude information). This is sometimes referred to as the linear spectrum.

The phase of the spectrum is meaningful only if the time record is triggered with a fixed relationship to the input signal. If the signal is repetitive as well (the signal and trigger repeat), then vector averaging can be used to reduce the noise level of the spectrum. The vector averaged spectrum is still a complex quantity.

The rms averaged spectrum is sometimes called the power spectrum. The power spectrum gives a stable (and usually more accurate measure) of the rms signal amplitudes and rms noise levels. The rms averaged spectrum is also a complex quantity.

Time Record

A time record is simply a sequence of data samples. The duration of the time record is the FFT resolution/span.

For baseband spans (spans which start at DC), the time record resembles a digital oscilloscope display. Signals at frequencies above the span have been filtered out. Baseband time records are entirely real, they have no imaginary part.

For zoomed spans (spans which start above DC), the time record display does NOT resemble the original data. The data has been frequency shifted. Signals at the center of the span appear at DC while frequencies at both edges of the span appear as high frequencies. Zoomed time records are complex, they have both a real and an imaginary part. The sampling rate is always half of the equivalent baseband span.

Some points to remember,

1. The time record is not a continuous representation of the input signal. The data is sampled and has a time resolution of $1/(\text{sample rate})$. High frequency signals will appear distorted in the time record. However, ALL of the spectral information is preserved by the Nyquist sampling theorem as long as the value of each sample is accurate.
2. Averaging does not affect the time record. Averaging is performed on the FFT spectrum and not on the time data.
3. Amplitude calibration is performed in the frequency domain. Hence, the time record amplitudes are not calibrated.
4. A triggered time record will always jitter by 1 sample. This jitter is removed in the computation of the phase of the spectrum relative to the trigger.

Averaged and calibrated time records can be obtained using a User Math function (using inverse FFT).

Windowed Time Record

The FFT operates on windowed time records. The window function is applied to the time record immediately before the FFT. Most window functions taper off to zero at the start and end of the time record. If a transient signal occurs at the start of the time record, the corresponding windowed time record and FFT may not show anything because the window function reduces the transient to zero.

Orbit

The Orbit measurement is a two channel measurement whose real part is the real part of Time Record Ch1 and whose imaginary part is the real part of Time Record Ch2. Orbit is normally displayed with the Nyquist View (Time2 vertical vs Time1 horizontal).

For baseband spans, the time records are entirely real and the Nyquist view of the Orbit measurement is a Lissajous figure.

Cross Spectrum

The cross spectrum (sometimes called cross power spectrum) is a two channel measurement defined as

$$\text{Cross Spectrum} = \text{Avg}(\text{conj}(\text{FFT1}) \cdot \text{FFT2})$$

where $\text{Avg}()$ is the averaging selected in the [Average] menu. Both channels use the window selected in the [Window] menu.

The cross spectrum contains both magnitude and phase information. The phase is the relative phase (at each frequency) between the two channels. Vector averaging can be used to eliminate signals which do not have a constant phase relationship between the two channels. In this case, triggering may not be required for vector averaging.

The magnitude is simply the product of the magnitudes of each spectrum. Frequencies where signals are present in both spectra will have large components in the cross spectrum.

Transfer Function

The transfer function (sometimes called frequency response) is a two channel measurement which ratios the spectrum of Ch 2 to the spectrum of Ch 1. Transfer function measures the response of a network or device under test. The reference channel (1) measures the signal at the input to the device and the response channel (2) measures the device output. The result is the complex transfer function of the device.

A broadband source (such as chirp or noise) should be used to measure transfer function.

There are two types of transfer function which differ in their averaging.

<F2/F1>

$$\langle F2/F1 \rangle = \text{Avg}(\text{FFT2} / \text{FFT1})$$

where $\text{Avg}()$ is the averaging selected in the [Average] menu. Both channels use the window selected in the [Window] menu.

The transfer function contains both magnitude and phase information. The phase is the relative phase (at each frequency) between the two channels. Vector averaging can be used to eliminate signals which do not have a constant phase relationship between the two channels. In this case, triggering is not required for vector averaging.

<F2>/<F1>

$$\langle F2 \rangle / \langle F1 \rangle = \text{Avg}(\text{FFT2}) / \text{Avg}(\text{FFT1})$$

where Avg() is the averaging selected in the [Average] menu. Both channels use the window selected in the [Window] menu.

In this case, each channel is averaged separately and thus vector averaging does not preserve cross channel phase relationships on a time record by time record basis. In this case, triggering is required for vector averaging.

Force-Exponential

Many impact measurements require the Force window for Ch1 (impulse) and the Exponential window for Ch2 (response). Use User Math to define a user function as FFTb(2)/FFTa(1). In this case, the FFT of Ch2 uses the window of DisplayB and the FFT of Ch1 uses the window of DisplayA, regardless of which display is showing the function. Simply un-link the [Window]<Window> entry and assign the Force window to DisplayA and the Exponential window to DisplayB.

Coherence

The coherence function is a two channel measurement defined as

$$\text{Coherence} = \text{Mag}^2(\text{VecAvg}(\text{CrossSpec})) / (\text{Pwr1} \cdot \text{Pwr2})$$

$$\begin{aligned} \text{where} \quad \text{CrossSpec} &= \text{conj}(\text{FFT1}) \cdot \text{FFT2} \\ \text{Pwr1} &= \text{Mag}^2(\text{RMSAvg}(\text{FFT1})) \\ \text{Pwr2} &= \text{Mag}^2(\text{RMSAvg}(\text{FFT2})) \end{aligned}$$

Averaging is always On and the Averaging Modes are defined by the measurement above. The Type and Number Of Averages are still selected in the [Average] menu. Both channels use the window selected in the [Window] menu.

Coherence is a unitless real quantity and varies from 1.0 (perfect coherence) to 0.0 (no coherence). Coherence measures the percentage of power in the response channel (2) which is caused by (phase coherent with) power in the reference or input channel (1). Ideally, a coherence of 1.0 means that the corresponding transfer function is completely legitimate. All of the response power came from power at the input. If there is noise or other signals generated from within the device under test (which is not related to the input signal), it will result in a coherence of less than 1.0.

Auto Correlation

Auto correlation is a single channel measurement. In the time domain, it is a comparison of the signal $x(t)$ with a time shifted version of itself $x(t-\tau)$ displayed as a function of τ . This is useful for detecting similarities which occur at different times. For example, echoes show up as peaks separated by the echo time. Sine waves appear as sine waves in auto correlation and square waves appear as triangles. Signals which do not repeat or are completely random (such as noise) appear only at $\tau = 0$.

The definition of Auto Correlation depends upon the Average Mode selected in the [Average] menu.

Averaging Off

$$\text{Auto Correlation} = \text{invFFT}(\text{FFTuN} \cdot \text{conj}(\text{FFTN}))$$

Peak Hold or RMS Averaging On

$$\text{Auto Correlation} = \text{invFFT}(\text{VecAvg}(\text{FFTuN} \cdot \text{conj}(\text{FFTN})))$$

Vector Averaging On

$$\text{Auto Correlation} = \text{invFFT}(\text{VecAvg}(\text{FFTuN}) \cdot \text{conj}(\text{VecAvg}(\text{FFTN})))$$

where N is Channel 1 or 2. FFT is a windowed FFT, FFTu is an un-windowed FFT (uniform window) and invFFT is an inverse FFT.

Correlation is a real function and requires a baseband span (real time record). Non-baseband time records do not preserve the original signal frequencies and thus do not yield the correct correlation. A display which is measuring a single channel correlation will have its start frequency set to 0 Hz.

A correlation window is applied to the time record of one FFT in the computation. This is because the FFT models the time domain as a single time record repeating itself over and over. Computing the correlation over a τ greater than half of the time record length will result in 'wrap around' where the correlation starts to repeat itself. To avoid this, special windows which zero half of the time record are used. The $[0..T/2]$ window zeroes the second half of the time record and the $[-T/4..T/4]$ window zeroes the first and last quarter of the time record. The $[-T/2..T/2]$ is a uniform window which should only be used on data which is self windowing (lasts less than half of the time record).

Overlap processing is not allowed for averaged auto correlation. The Time Record Increment is ignored and 100% increment is used.

Cross Correlation

Cross correlation is a two channel measurement. In the time domain, it is a comparison of a signal $x(t)$ with a time shifted version of another signal $y(t-\tau)$ displayed as a function of τ . This is useful for detecting signals common to both channels but shifted in time.

The definition of Cross Correlation depends upon the Average Mode selected in the [Average] menu.

Averaging Off

$$\text{Cross Correlation} = \text{invFFT}(\text{FFTu2} \cdot \text{conj}(\text{FFT1}))$$

Peak Hold or RMS Averaging On

$$\text{Cross Correlation} = \text{invFFT}(\text{VecAvg}(\text{FFTu2} \cdot \text{conj}(\text{FFT1})))$$

Vector Averaging On

$$\text{Cross Correlation} = \text{invFFT}(\text{VecAvg}(\text{FFTu2}) \cdot \text{conj}(\text{VecAvg}(\text{FFT1})))$$

where FFT1 is the windowed FFT of Channel 1, FFTu2 is the un-windowed FFT (uniform window) of Channel 2 and invFFT is an inverse FFT.

Correlation is a real function and requires a baseband span (real time record). Non-baseband time records do not preserve the original signal frequencies and thus do not yield the correct correlation. A display which measures cross correlation will set the start frequency of both displays to 0 Hz.

A correlation window is applied to the time record of Ch1 in the computation. This is because the FFT models the time domain as a single time record repeating itself over and over. Computing the correlation over a τ greater than half of the time record length will result in 'wrap around' where the correlation starts to repeat itself. To avoid this, special windows which zero half of the time record are used. The $[0..T/2]$ window zeroes the second half of the time record and the $[-T/4..T/4]$ window zeroes the first and last quarter of the time record. The $[-T/2..T/2]$ is a uniform window which should only be used on data which is self windowing (lasts less than half of the time record).

Overlap processing is not allowed for averaged auto correlation. The Time Record Increment is ignored and 100% increment is used.

Capture Buffer

The capture buffer stores sequential time domain input data in memory. See 'Capture' later in this section for more details. The Capture measurement displays the contents of the capture buffer. The FFT and Octave Measurement Groups can use this stored data as input data by choosing Playback as the Input Source in the [Input] menu.

The capture buffer is often very long. To graphically expand a region of the display, use the Pan and Zoom functions in the [Display Setup] menu. The capture buffer display can automatically pan with the capture fill or playback progress through the buffer. During capture fill, if the capture buffer accumulates points faster than they be displayed, some points are not shown. This speeds up the display update so that it keeps up with the real time capture but allows visual aliasing to occur. Once capture is complete, the display is redrawn showing the envelope of all points, eliminating any visual aliasing effects.

To measure from a region of the buffer, set the Playback Start and Length in the [Input] menu. During playback, a marker at the bottom of the graph indicates the current time record position within the buffer.

The capture data is filtered and down-sampled according to the capture Sample Rate. Only baseband data (bandwidth starts at DC) are captured. The capture buffer resembles a digital oscilloscope display. Signals at frequencies above the sample rate/2.56 have been filtered out.

The capture buffer is not a continuous representation of the input signal. The data is sampled and has a time resolution of $1/(\text{sample rate})$. High frequency signals will appear distorted in the time record. However, ALL of the spectral information (up to the sampling rate/2.56) is preserved by the Nyquist theorem as long as the value of each sample is accurate.

Amplitude calibration is performed in the frequency domain. Hence, the captured time data amplitudes are not calibrated.

User Function

User Function displays the results of a user defined math function. User Functions defined within the FFT Measurement Group may include FFT measurements. Use the [User Math] menu to define a math function.

A User Function may not be selected as the measurement if it uses a Trace which is empty or which contains data taken in a different Measurement Group.

See 'User Math' later in this section for more.

Views

Each measurement has an associated view. A view is a way of looking at the complex measurement data.

Log Magnitude

Log magnitude view graphs the log of the magnitude of the measurement data. The magnitude is $\sqrt{(x^2 + y^2)}$ where x is the real part and y is the imaginary part. The Y axis of the display is logarithmic in scaling.

Linear Magnitude

Linear magnitude view graphs the magnitude of the measurement data. The magnitude is $\sqrt{(x^2 + y^2)}$ where x is the real part and y is the imaginary part. The Y axis of the display is linear in scaling.

Magnitude²

Magnitude² view graphs the magnitude squared of the measurement data. The magnitude squared is $(x^2 + y^2)$ where x is the real part and y is the imaginary part. The Y axis of the display is linear in scaling.

Real Part

Real Part view graphs the real part of the measurement data. The Y axis of the display is linear in scaling.

Imaginary Part

Imag Part view graphs the imaginary part of the measurement data. The Y axis of the display is linear in scaling.

Real measurement data, such as baseband time record, have zero imaginary part. This view is zero for all points.

Imaginary data arises from the multiplication of the input time data by sine and cosine (heterodyne). Signals in phase with cosine result in real data, signals in phase with sine result in imaginary data. The real and imaginary parts represent data 90 degrees out of phase.

Phase

Phase view graphs the phase of the measurement data. The phase is a four-quadrant quantity defined as $\theta = \arctan(y/x)$ where y is the imaginary part and x is the real part and y is positive. If y is negative, the phase is negated. Phase is graphed linearly from -180 ($-\pi$) to $+180$ (π) degrees (radians). To show unwrapped phase, choose the Unwrapped Phase view.

Real measurement data, such as baseband time record, have zero imaginary part. The phase is zero for all points.

Single channel phase is relative to the center of the time record for Uniform, BMH, Hanning, Flattop and Kaiser windows. For Force and Exponential windows, phase is relative to the start of the time record. For User windows, the Window Form is user

specified. In general, single channel phase is useful only when the time record is triggered in phase with the signal.

For two channel measurements, the phase is channel 2 relative to channel 1. Triggering is not always required for meaningful two channel phase measurements.

Phase Suppress sets the phase of small data values to zero. This avoids the messy phase display associated with the noise floor. (Remember, even a small signal has phase.) Set the Phase Suppress threshold in the [Display Options] menu.

Watch Out For Triggered Sources

If a triggered source is selected (Chirp, Burst Chirp, Burst Noise or Arbitrary), the triggered measurement phase is stable only if the input signals are derived from the source output. Turn the source off (or set it to Sine) when making triggered measurements without the source.

Watch Out For Phase Errors

The FFT can be thought of as a set of bandpass filters, each centered on a frequency bin. The signal within each filter shows up as the amplitude of each bin. If a signal's frequency is between exact FFT frequency bins, the filters cause phase errors. Because these filters are very steep and selective, they introduce very large phase shifts for signals not exactly on a frequency bin. Use the SR780 source to generate exact bin frequencies whenever possible.

Unwrapped Phase

Unwrapped Phase view graphs the phase of the measurement data as a continuous function without 'wrapping' around at ± 180 degrees. This view is generally meaningful only for measurements which have data at every frequency point (such as chirp source or swept sine).

The phase θ is calculated for each point as in the 'wrapped' Phase view. The wrapping starts at the left edge of the display. The value of $\theta \pm (n \times 360 \text{ deg.})$ which is closest to the phase of the previous bin is assigned to each bin (n is an integer).

Single channel phase is relative to the center of the time record for Uniform, BMH, Hanning, Flattop and Kaiser windows. For Force and Exponential windows, phase is relative to the start of the time record. In general, single channel phase is useful only when the time record is triggered in phase with the signal.

For two channel measurements, the phase is channel 2 relative to channel 1. Triggering is not always required for meaningful two channel phase measurements.

Phase Suppress sets the phase of small data values to zero. This avoids the messy phase display associated with the noise floor. (Remember, even a small signal has phase.) Set the Phase Suppress threshold in the [Display Options] menu.

Nyquist Plot

The Nyquist Plot graphs complex measurement data as imaginary part (along the Y axis) versus real part (along the X axis). The graph is scaled linearly. Adjacent frequency (time) points are connected by a line. This view is generally meaningful only for

measurements which have data at every frequency point (such as chirp source or swept sine).

The Marker Position Bar shows the real and imaginary parts of each point as well as its frequency (or time). The marker moves sequentially through the frequency (time) points and can be linked to the frequency of the other display.

Real measurement data, such as baseband time record, have zero imaginary part. This view is entirely along the X axis.

Nichols Plot

The Nichols Plot graphs complex measurement data as log magnitude (along the Y axis) versus unwrapped phase (along the X axis). The Y axis is logarithmic and the X axis is linear. Adjacent frequency (time) points are connected by a line. This view is generally meaningful only for measurements which have data at every frequency point (such as chirp source or swept sine).

The marker readout shows the log magnitude and phase of each point as well as its frequency or time. The marker moves sequentially through the frequency (time) points and can be linked to the frequency of the other display.

Real measurement data, such as baseband time record, have zero phase. This view is entirely along the Y axis.

FFT Averaging

Averaging successive measurements together improves accuracy and repeatability. For measurements computed from multiple spectra, averaging is performed on measurement results or individual spectra depending upon the measurement definition. Time records are not averaged.

RMS Averaging

RMS averaging computes the average of the real part (X) and imaginary part (Y) of a measurement according to

$$X_{avg} = \sqrt{\text{mean}(X^2)} \text{ and } Y_{avg} = \sqrt{\text{mean}(Y^2)}$$

Linear averaging computes the equally weighted mean of X^2 and Y^2 over N measurements. Exponential averaging weights new data more than old data and yields a continuous moving average.

RMS averaging reduces fluctuations in the data but does not reduce the actual noise floor (squared values never cancel). With a sufficient number of averages, a very good approximation of the actual noise floor can be measured.

Log Magnitude view is normally used with rms averaged measurements. Since rms averaging involves squared amplitudes, the real and imaginary parts of the average are always positive. The phase of an rms averaged measurement is limited to the first quadrant (0-90 deg).

Vector Averaging

Vector averaging computes the average of the real part (X) and imaginary part (Y) of a measurement according to

$$X_{avg} = \text{mean}(X) \text{ and } Y_{avg} = \text{mean}(Y)$$

Linear averaging computes the equally weighted mean of X and Y over N measurements. Exponential averaging weights new data more than old data and yields a continuous moving average.

Since signed values are combined in the mean, random signals tend to average to zero. This reduces the noise floor since random signals are not phase coherent from measurement to measurement. Only signals with a constant phase have real and imaginary parts which repeat from time record to time record and are preserved. Vector averaging can substantially improve the dynamic range of a measurement as long as the signals of interest have stable phases.

For single channel measurements, vector averaging requires a trigger. The signal of interest MUST be phase synchronous with the trigger to have a stable phase.

For a two channel measurement, the phase is relative between Channel 2 and Channel 1. As long as the signals of interest have stable relative phases, triggering is not required for vector averaging. Triggering is still required to isolate time records which contain the signals of interest.

Peak Hold Averaging

Peak Hold is not really averaging, rather the magnitude of the new data is compared to the magnitude of the averaged data, and if the new magnitude is larger, then the new data becomes the averaged data. This is done on a frequency bin by bin basis. The result is averaged data with the largest magnitudes which occurred over a number of measurements. Peak Hold can compare a fixed number of measurements or run continuously.

Peak Hold detects the peaks in the magnitudes but stores the data points in their original complex form.

Linear Weighting

Linear weighting combines N (Number Of Averages) measurements with equal weighting in either RMS or Vector averaging.

While Linear averaging is in progress, the number of averages completed is shown in the Horizontal Scale Bar below the graph. When the Number Of Averages has been completed, the measurement stops and 'Done' is displayed below the graph.

Waterfall Storage

If Waterfall Storage is on, the waterfall buffer only stores the completed linear averages, not each individual measurement. Each time the linear average is done, the result is stored in the waterfall buffer and the average is reset and started over (instead of stopping). Each completed average counts as a single waterfall record.

Exponential Weighting

Exponential weighting weights new data more than old data. For RMS and Vector averaging, weighting takes place according to

$$\text{Average}_N = (\text{New Data} \cdot 1/N) + (\text{Average}_{N-1}) \cdot (N-1)/N$$

where N is the number of averages.

While Exponential averaging is in progress, the number of averages completed is shown in the Horizontal Scale Bar below the graph. The displayed number stops incrementing at the Number of Averages while the averaging continues.

Exponential weighting reaches a steady state after approximately N measurements. Once in steady state, further changes in the average are detected only if they last for a sufficient number of measurements. Make sure that the number of averages is not so large as to eliminate changes in the data which might be important.

Real Time Bandwidth and Overlap

What is Real Time Bandwidth?

The Real Time Bandwidth is the largest frequency span whose corresponding time record exceeds the time it takes to compute the FFT measurement. At this span and narrower spans, it is possible to compute the measurement for every time record without skipping any input data. The spectra are computed in "real time".

At spans larger than the real time bandwidth, the measurement computations take longer than a time record. The analyzer can not keep up and some input data must be ignored. Data is lost between time records while the computations are in progress.

For FFT Resolutions greater than 100 lines, the SR780 can usually compute the measurements in both displays in less than a time record for all spans. This includes the real time digital filtering and heterodyning, the FFT processing, and averaging calculations. The real time bandwidth in this case is 102.4 kHz. Every input sample contributes to a time record and a measurement.

Measurements involving User Functions may take longer and may not be real time.

Averaging Speed

Real time bandwidth has a direct affect on measurement times when Averaging is On. Consider the averaging of full span (102.4 kHz) 400 line FFT's. If the real time bandwidth is only 10 kHz (as in many analyzers), it takes 40 ms to compute the measurement for a 4 ms time record. This means 9 out of every 10 time records are ignored and only 25 full span measurements can be computed in a second. When averaging is on, this usually drops to 10 measurements per second. At this rate it's going to take a couple of minutes to do 500 averages.

The SR780, on the other hand, can make real time measurements at full span (102.4 kHz). This results in 256 measurements per second (on each display!). In fact, this is so fast, that the display can not be updated for each new measurement. The display only updates about 8 times a second. However, when Averaging is On, all of the measurements contribute to the average. The time to complete 500 averages is only a few seconds. (Instead of a few minutes!)

Overlap Processing

What about narrow spans where the time record is long compared to the processing time? The analyzer computes one measurement per time record and waits and does nothing until the next time record is complete. The update rate is one measurement per time record. With narrow spans, this is quite slow.

With overlap processing, the analyzer does not wait for the next complete time record before computing the next measurement. Instead, it uses data from the previous time record as well as data from the current time record to compute the next measurement. This speeds up the update rate. Remember, most window functions are zero at the start and end of the time record. Thus, the points at the ends of the time record do not contribute much to the FFT. With overlap, these points are "re-used" and appear as middle points in other time records. This is why overlap effectively speeds up averaging and smoothes out window variations.

Typically, time records with 50% overlap provide almost as much noise reduction as non-overlapping time records when RMS averaging is used. When RMS averaging narrow spans, this can reduce the measurement time by 2.

Time Record Increment

The Time Record Increment is how far the start of each time record is advanced between measurements (as a percentage of the time record length).

If the increment is 100%, the start of the next time record is exactly one time record advanced from the start of the previous time record (no overlap).

If the increment is 25%, then the next time record starts 1/4 of a time record advanced from the start of the previous time record. This is referred to as 75% overlap since the two time records share 75% of a record. The overlap is simply 100% minus the Time Record Increment.

When the Time Record Increment is less than or equal to 100%, the measurement is real time. All time points contribute to one (or more) measurements.

If the increment is 200%, the start of the next time record is advanced from the start of the previous time record by 2 time records leaving a gap of 1 record. This means that the data between the two time records is not measured.

When the Time Record Increment is greater than 100%, then the measurement is not real time and some time points do not contribute to a measurement.

The actual time record increment for the measurements in progress is displayed in the Real Time indicator in the status area (below the Input Ranges). If the indicator shows a value greater than the requested Time Record Increment, it means that the measurement cannot be made with the requested increment but is running with the smallest increment possible. Factors which affect the processor's ability to run real time include the measurement type, averaging and source type.

Settling

When the frequency span or input signal path (gain, filtering, etc.) is changed, a settling time is required before the FFT measurement is considered settled or valid. The measurement is not settled until the discontinuity in the input data has propagated through the digital filters and a complete new time record has been acquired.

If the time record increment is 100%, unsettled measurements are not displayed. After a change is made which unsettles the measurement, new data is not displayed until the filters are settled and a complete time record has been acquired.

If the measurement is running with a time record increment less than 100% and the measurement is unsettled, unsettled measurements may be displayed. New data is displayed after the filters are settled and a portion of the new time record has been acquired. For example, if the time record increment is 25%, 3 measurements are made before a complete new time record has been acquired. These first 3 measurements have time records which contain data from before AND after the measurement was unsettled. These unsettled measurements are displayed in half intensity indicating that the

measurement is not settled. Once the 4th measurement is complete, the display returns to full intensity since the measurements have completely settled time records.

If averaging is on, changes which unsettle the measurement will restart the average. Unsettled measurements are not included in the new average. Averaging does not start until the measurement is settled. When the time record increment is less than 100%, 'Settle' is displayed (instead of the number of averages) below the graph to indicate that the unsettled measurements are not being averaged.

Vector Averaging

If the measurement is vector averaged, then Time Record Increment is ignored (100% is used). Overlapping time records are not allowed in this case.

Triggering

If the measurement is triggered, then Time Record Increment is ignored. Time records always start with the trigger (with the specified Trigger Delays). The analyzer must be in Free Run Trigger Mode to use overlap processing.

Waterfall Display

What is a Waterfall?

Waterfall displays show multiple measurement results (records) in a single display. New records are added at the top of the display and older records scroll off the bottom of the display. This gives a time history of the measurement. An example is shown below.

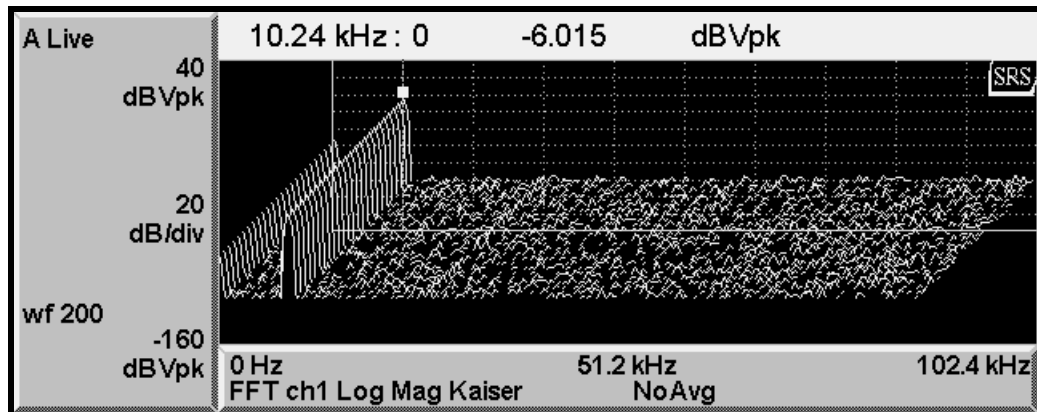

Figure Chapter 2 -1 Waterfall Display

Waterfall Storage saves measurement records in waterfall memory. The number of records which may be stored depends upon the allocated memory and the type of measurement. The rate at which records are put into memory is programmable.

Waterfall display WITH storage shows only records which are stored in waterfall memory. While the measurement is running, the display scrolls down and new records are added at the top (back). The display may not scroll fast enough to show every stored record in real time. When the measurement is paused, the display is redrawn with either the newest record in back (normal) or the oldest record in back (reversed). When paused, every stored record which is visible in the display is shown. The marker can access the data in any stored record and scroll the display through the entire waterfall buffer.

Waterfall display WITHOUT storage is simply a graphical display scrolling. The marker is constrained to the most recent record. Older records are only shown graphically, their data has not been saved and may not be accessed in any way. In this case, the display updates and scrolls as quickly as possible.

The [Waterfall] menu configures both waterfall storage and display.

Waterfall displays are not available for Nyquist or Nichols Views or for Swept Sine measurements.

Waterfall Storage

Waterfall records are stored in waterfall memory. This memory is not retained when the power is off. Use the [Waterfall] <Memory Allocation> menu to allocate memory between the capture buffer, waterfall storage and the arbitrary source waveform.

Waterfall memory must be allocated before waterfall storage may be used.

The number of measurement records which are stored in waterfall memory is set by the Waterfall Total Count. The maximum Total Count depends upon the allocated memory and the type of measurement. The amount of waterfall memory available for each display is always half of the allocated waterfall memory. For example, 500 blocks of allocated waterfall memory is allocated as 250 blocks for each display. For 400 line FFT measurements, This memory can store 500 measurement records from each display in waterfall memory.

The rate at which measurement records are added to waterfall memory is set by the Waterfall Skip/Storage Interval. This allows the waterfall memory to hold a longer time history as well as setting a variable storage rate.

In FFT group, for every measurement added to memory, a skip number of measurements are not stored. For example, a skip of 0 stores every measurement in memory. A skip of 10 stores every 11th measurement in memory (store 1, skip 10). The skipped measurements are still computed and affect (exponential) averaging, they are simply not stored. The elapsed time between stored records (1/storage rate) is simply skip+1 times the FFT acquisition time times the time record increment. (In the case of triggered measurements, skip+1 times the trigger period). This allows the time between stored records to be determined exactly.

In Octave group, the Storage Interval is set as a time. In this case, a snapshot is stored to memory every Storage Interval amount of time.

The Skip/Storage Interval has no effect if the measurement is linear averaged. In this case, the result of each complete linear average is stored in the waterfall buffer and the average is reset and started over again. Change the Number of Averages (FFT) or Integration Time (Octave) to change the storage rate.

Waterfall Display

To view a waterfall display, set [Waterfall]<Display> to Waterfall. The View Count sets the number of records displayed and the Trace Height sets the percentage of the display height for the Y axis. Scroll Angle and Fast Angles set the angle at which successive records are scrolled in the display. Scrolling at an angle allows changes at a constant frequency to be viewed more easily but takes longer to update the display. Fast Angles limits the choice of Angles to those which scroll faster. The Threshold sets the baseline suppress threshold and Hidden Lines specifies whether portions of a record which are 'hidden' behind other records will be shown.

The Paused Drawing mode determines how the display is drawn when the measurement is paused. Normal displays the newest record at the top (back). Oldest at Top displays the oldest record at the top (back). This is reversed from how the display is scrolled while the measurement is running.

A single record can be saved to a trace. A time slice (history of a single X from all stored records) can also be saved to a trace.

Capture Buffer

Input Capture samples the analog inputs at a selected sample rate and stores the samples in memory. Storage is continuous and real-time without interruption in the data stream. Triggering only starts the capture, it does not synchronize individual time records.

Captured data can be used as the measurement input for the FFT and Octave Measurement Groups (capture playback). The capture buffer can neither be filled nor measured from in the Swept Sine Measurement Group.

Use the [Capture] <Memory Allocation> menu to allocate memory between the capture buffer, waterfall storage and the arbitrary source waveform. Capture memory must be allocated before the capture buffer may be used.

Input Sampling

The input data is always digitized at the maximum sample rate. The maximum sampling rate is 262.1 kHz when the FFT Base Frequency is 102.4 kHz and 256 kHz when the FFT Base Frequency is 100.0 kHz OR the Measurement Group is Octave. When capturing data in the FFT Measurement Group, it is important to choose the 100.0 kHz Base Frequency if the captured data will be played back in the Octave Group.

After the inputs are digitized, they may be filtered and downsampled before being stored in the capture buffer. This allows longer capture times at lower sampling rates. The capture data represents a frequency span from 0 Hz to the sampling rate/2.56. All captured data is baseband. Capturing at less than the maximum sampling rate restricts the playback measurement span to sampling rate/2.56.

The Capture Length is selected in 2 kPoint (2048) increments limited by the user memory allocation. A single input or both inputs may be captured. The maximum capture length for a single input is twice the length for both inputs at a given memory allocation.

Capture Fill

To start capture, press the [Start Capture] key. If the Trigger Mode is Free Run, capture starts immediately. Otherwise, the selected Trigger will be in effect and the next trigger event will start capture. The Capture Progress indicator shows how much of the desired capture length has been filled. If the Capture Mode is 1-Shot, capture stops when the buffer is full. Press [Stop Capture] to halt capture before the buffer is full.

If the Capture Mode is Continuous, once capture is started, it continues indefinitely and fills the capture buffer in a circular fashion. In this case, press [Stop Capture] to halt capture with the most recently acquired data stored in the buffer.

While capture is in progress, the displays do not update unless the measurement is a Capture buffer. Use Zoom and Pan to inspect a portion of the buffer. The capture buffer display can automatically pan as the capture progresses through the buffer. During capture, if the capture buffer accumulates points faster than can be displayed, some points are not displayed. This speeds up the display update so that it keeps up with the real time capture data but allows visual aliasing to occur. Once capture is complete, the display is redrawn showing the envelope of all points, eliminating any visual aliasing effects.

Capture Playback

Captured data can only be played back in a measurement with the same maximum sampling rate. Data digitized at 262.1 kHz can only be played back in FFT Group with the Base Frequency set to 102.4 kHz. Data digitized at 256 kHz can be played back in both Octave and FFT Group as long as the FFT Base Frequency set to 100.0 kHz.

Choose Playback as the Input Source in either Octave or FFT Measurement Group. Set the Playback Start point within the capture buffer and the Playback Length. When playing back in FFT Group, it is best to set the Playback Length to a multiple of the FFT time record (Acquisition Time).

The Capture Progress indicator shows the playback progress through the buffer (relative to Playback Length).

The capture buffer itself can be displayed as a measurement. Use Zoom and Pan to inspect a portion of the buffer. During playback, the capture buffer display can automatically pan as the playback progresses through the buffer. During playback, a marker at the bottom of the graph indicates the current time record position within the buffer.

The capture data represents a frequency span from 0 Hz to the sampling rate/2.56. The playback measurement cannot exceed this measurement bandwidth. In the Frequency menu, this places a limitation on the maximum FFT span and stop frequency or highest Octave band during playback. The Average, Window and Waterfall menus all operate normally during playback.

The Playback Mode can be either 1-Shot (once through the buffer) or Circular (repeat over and over). In 1-Shot playback, the buffer is played a single time. The playback halts when the end of the buffer is reached. In Circular playback, the playback starts over when the end of the buffer is reached. There is often a discontinuity in the playback measurement when the playback jumps from the end to the start of the buffer. In either mode, press [Start/Reset] to restart playback at the start again.

Normal Playback Speed plays back the capture buffer in real time, i.e. 1 second of capture takes 1 second to play back. Normal Playback Speed looks like the 'live' real time measurement. When the playback is in Octave Group, playback is always Normal Speed.

When playback is in FFT Group, the Playback Speed can be either Normal or Every Time Record.

Normal Playback Speed plays back the capture buffer in real time, i.e. 1 second of capture takes 1 second to playback. Normal Speed playback looks like the 'live' real time measurement. Normal playback is limited to the real time limitations of the equivalent real time analog input measurement.

Not all time records are displayed during Normal playback though all time records contribute to averaged measurements. For example, 1 second of capture contains 256 full span FFT time records. Normal Speed playback at full span takes 1 second and updates the display only about 8 times during playback.

Every Time Record playback displays the measurement result for every captured time record. Since the data is stored in memory, Every Time Record playback is not limited by real time considerations. For example, 1 second of capture can contain 256 full span FFT time records. In this case, all 256 time records are measured AND displayed. The display still updates at 8 Hz so playback takes about 32 seconds to complete. If the time records are overlapped, there may be more than 256 measurements to display and playback will take even longer.

When the measurement time records are very long (narrow spans), the time to process and display each measurement is much less than the real time record length. Since the data is already available in the capture buffer, Normal Speed playback means waiting unnecessarily for a real time record to elapse between updates. In this case, Every Time Record playback displays the measurements of all captured time records much faster than Normal Speed real time playback.

When the playback is in Octave Group, playback is always Normal Speed .

Capture as the Arbitrary Source

The contents of the capture buffer can be used as the arbitrary source. This allows a captured waveform to be output as the source. The output sample rate should be the same as the capture sample rate to maintain the correct signal frequencies. If the output sample rate is less than the maximum sampling rate (262 or 256 kHz), then the source output will contain aliases. In this case, be sure to limit the measurement bandwidth to the sampling rate/2.56 to eliminate the effect of these aliases on the measurement.

The amplitude of the arbitrary output depends upon the amplitude of the captured data relative to the Input Range during capture. If the captured data was 100% of the Input Range, then an output amplitude of 100% will be 1 Vpk.

The Source

The SR780 source provides a variety of test signals which allow the SR780 to measure the response of electronic, mechanical and acoustic devices, without the need for an external generator. In many cases, the SR780 source is better than an external source since it is synchronous with the input sampling.

Sine

A low distortion sine wave for general purpose gain, distortion and signal/noise measurements. The sine source is synchronous with the FFT, i.e. sine waves can be generated at exact bin frequencies of the FFT. This can eliminate windowing effects in the measured amplitude and phase.

Two Tone

Two low distortion sine waves can be generated simultaneously for intermodulation distortion tests (IMD). Each tone has independent frequency and amplitude settings.

Chirp

The Chirp source provides an equal amplitude sine wave at each bin of the displayed spectrum. For a 400 point FFT, the output is the sum of 400 discrete sine waves. The phases of each sine wave are arranged so that they do not add in phase resulting in a low crest factor (ratio of peak to rms). This source is useful for measuring transfer functions quickly without having to make many discrete measurements using a single sine wave.

The Burst Chirp is a sweep over the FFT frequency span in a time less than the time record. Burst Chirp is only available for FFT measurements.

Noise

Broadband noise is useful for characterizing circuits, mechanical systems or even the audio response of an entire room. White noise provides equal amplitude per root Hz from 0 to 102 kHz, regardless of the measurement span. White noise is useful in electronic applications. Pink noise rolls off at 3 dB/oct providing equal amplitude per octave. Pink noise is preferred in audio applications.

White Noise can be bandlimited to the frequency span of the measurement.

Since the signal is noisy and random, FFT windows are always required when using the Noise source.

Burst Noise is noise output for a fraction of the time record (FFT) or Source Period (Octave).

Arbitrary

The Arbitrary source plays a waveform stored in memory. The waveform can be either Capture buffer or the Arbitrary Waveform memory. Use the <Memory Allocation> menu to allocate memory between the capture buffer, waterfall storage and the arbitrary source waveform.

The Arbitrary waveform memory can be loaded via the computer interfaces, from a disk file or from a stored trace. The Capture buffer is filled with input samples.

The Arbitrary source can play a portion of memory starting at a specified point. The output sampling rate can also be specified. The full scale amplitude of the source is set as a percentage of 1 Vpk.

Windowing

The Sine, Two Tone, and Chirp sources can be used with or without a window function.

The Sine and Two Tone frequencies can be set at exact bin frequencies of the spectrum, hence they can be exactly periodic in the time record. As long as the signal to noise at the input is high, windowing is not required.

The Chirp waveform consists of many sine waves, each one perfectly periodic in the time record. The Chirp waveform **REQUIRES** a Uniform window to result in a flat spectrum. This is because the individual frequency components do not have a constant amplitude over the time record. Windowing will attenuate certain portions of the spectrum.

Windowing is required when using the Noise source.

Source Trigger

The Sine, Two Tone, Chirp and Arbitrary sources can trigger the FFT time record to measure phase response and/or vector average. Select Source as the Trigger Source in the [Trigger] menu.

For Sine and Two Tone, the source frequencies must be set to a multiple of the linewidth in order for stable time records to be acquired. Random frequencies are not exactly periodic over a time record and do not result in a stable phase even with triggering.

For Burst Chirp and Burst Noise, Source trigger aligns the start of the time record with the start of the burst output.

Source trigger only applies to FFT measurements.

External Trigger

For Chirp, Burst Chirp, Burst Noise and Arbitrary, the External trigger can trigger the source output. The source can trigger on only the first trigger or on every trigger after a measurement is started as selected in the [Trigger] menu. The measurements are triggered normally in either case.

Octave Analysis

What is Octave Analysis?

An FFT measurement measures the power within equally divided frequency bins. Octave measurements use logarithmic frequency bands whose widths are proportional to their center frequencies. The bands are arranged in octaves with either 1, 3 or 12 bands per octave (1/1, 1/3 or 1/12 octave analysis). Octave analysis measures spectral power closer to the way people perceive sound, that is, in octaves. 1/3 octave analysis with A-weighting is the most common measurement for acoustics and sound.

To make an octave measurement, the input data passes into a bank of parallel digital filters. The filter center frequencies and shapes are determined by the type of octave analysis, either full (1/1), 1/3 or 1/12 octave, and comply with ANSI S1.11-1986, Order3, Type 1-D. The output from each filter is rms averaged to compute the power and displayed as a bar type graph. This is a real-time measurement of the power within each band and is the only available octave measurement. Since the bands are spaced logarithmically, octave graphs always have a logarithmic X-axis.

In addition to the octave bands, the sound level is also measured and displayed as the last band in the display. Exponential averaged sound power is calculated according to ANSI S1.4-1983, Type 0. Broadband Impulse and Peak measurements are made according to IEC 651-1979, Type 0.

Band Center Frequencies

Choose the number of bands per octave and the start and stop bands for the measurement within the [Frequency] menu.

The exact band center frequencies are calculated according to the ANSI standard. The displayed frequencies are sometimes rounded to even values for a simpler display. The filter shapes are third-order Butterworth with full, 1/3 or 1/12 octave bandwidth.

Full Octave Bands

Full octave bands are defined ranging from 125 mHz to 32 kHz. Up to 11 full octaves may be measured at one time. The exact centers are given by

$$\text{Center Frequency} = 1000 \times 2^n \quad \text{for } n = -13 \dots 5$$

1/3 Octave Bands

1/3 octave bands are defined ranging from 100 mHz to 40 kHz. Up to 11 octaves (33 bands) may be measured at one time. The exact centers are given by

$$\text{Center Frequency} = 1000 \times 2^{\left(\frac{n-30}{3}\right)} \quad \text{for } n = -10 \dots 46$$

1/12 Octave Bands

1/12 octave bands are defined ranging from 100 mHz to 12.34 kHz. Up to 11 octaves (132 bands) may be measured at one time. The exact centers are given by

$$\text{Center Frequency} = 1000 \times 2^{\left(\frac{1}{24}\right)} \times 2^{\left(\frac{n}{12}\right)} \quad \text{for } n = -160 \dots 43$$

Octave Measurements

Octave Analysis is a Measurement Group. Choose the Measurement Group within the [Display Setup] menu. The available measurements are rms averaged Octave spectrum (power spectrum), Capture Buffer and User Function.

Octave

This is the basic measurement of octave analysis. It is simply the rms averaged outputs from the parallel bank of octave filters (also called the power spectrum). The spectrum gives a stable reading of the rms signal amplitudes and noise levels within each band. RMS averaging results in a real spectrum and there is no phase information.

The number of Octave Channels limits the measurement choices of both displays.

If 2 Octave Channels are selected, then both inputs may be measured. The Measurements of both displays are independent. The Highest Band for all Octave Resolutions is decreased by 2 in this case.

If 1 Octave Channel is selected, then only one input may be analyzed. If both displays are making an octave measurement, they must both use the same input and frequency range. Changing the input or frequency range of the active display will change the other display if necessary. Choosing 1 Octave Channel may change the current measurements so that both displays use the same input.

Capture

The capture buffer stores sequential time domain data in memory. See 'Capture Buffer' for more details. The Capture measurement displays the contents of the capture buffer. Octave measurements can use this stored data as input data by choosing Playback as the Input Source in the [Input] menu.

The capture buffer is often very long. To graphically expand a region of the display, use the Pan and Zoom functions in the [Display Setup] menu. The capture buffer display can automatically pan with the capture fill or playback progress through the buffer. During capture fill, if the capture accumulates points faster than they can be displayed, some points are not shown. This speeds up the display update so that it keeps up with the real time capture but allows visual aliasing to occur. Once capture is complete, the display is redrawn showing the envelope of all points, eliminating any visual aliasing effects.

To measure from a region of the buffer, set the Playback Start and Stop in the [Input] menu.

The capture data is filtered and down-sampled according to the capture sample rate. Only baseband data (data bandwidth starts at DC) are captured. The capture buffer resembles a digital oscilloscope display. Signals at frequencies above the sample rate/2.56 have been filtered out.

The capture buffer is not a continuous representation of the input signal. The data is sampled and has a time resolution of $1/(\text{sample rate})$. High frequency signals will appear distorted in the time record. However, ALL of the spectral information is preserved by the Nyquist sampling theorem as long as the value of each sample is accurate.

Amplitude calibration is performed in the frequency domain. Hence, the captured time data amplitudes are not calibrated.

User Function

User Function displays the results of a user defined math function. User Functions defined within the Octave Analysis Measurement Group may include octave measurement results. Use the [User Math] menu to define a math function.

A User Function may not be selected as the measurement if it uses a Trace which is empty or which contains data taken in a different Measurement Group.

The number of Octave Channels limits the measurement choices of both displays. If 1 Octave Channel is selected, then only one input may be analyzed. If both displays are making an octave measurement, they must both use the same input. Changing the input of the active display will change the measurement or input of the other display if necessary. User Functions which use both inputs may not be measured. Choosing 1 Octave Channel may change the current measurements so that both displays use the same input.

See 'User Math' later in this section for more.

Octave Averaging

All octave measurements are averaged. There are four types of averaging - Linear Time, Exponential Time, Equal Confidence and Peak Hold.

Linear Time

The band filter outputs are equally weighted and averaged for an Integration Time.

While Linear averaging is in progress, the integration time completed is shown in the Horizontal Scale Bar below the graph. When the Integration Time has been completed, the measurement stops and 'Done' is displayed below the graph.

If Waterfall Storage is On, the waterfall buffer only stores the completed linear averages, not each individual measurement. Each time the linear average is done, the result is stored in the waterfall buffer and the average is reset and started over (instead of stopping). Each completed average counts as a single waterfall record.

Exponential Time

New filtered data is weighted more than older data. The exponential 'time constant' is the Integration Time. Averaging continues indefinitely.

While Exponential averaging is in progress, the completed integration time is shown in the Horizontal Scale Bar below the graph. The displayed time stops incrementing at the Integration Time while the averaging continues.

Exponential weighting reaches a steady state after approximately an integration time. Once in steady state, further changes in the average are detected only if they last for a sufficient number of measurements. Make sure that the integration time is not so large as to eliminate changes in the data which might be important.

Equal Confidence

Equal confidence averaging is exponential averaging where the integration time is set for each band separately. The integration times are set so that there is a 68% probability that the results are within the specified confidence level of the true mean for every band in the measurement. There is a 96% probability that the results are within twice the confidence level (in dB) of the true mean.

The effect of equal confidence averaging is that higher frequency bands have shorter time constants and lower frequency bands have longer time constants. This is very noticeable in the update of the display.

Peak Hold

Peak Hold displays the peak output from each band filter. The peak detection continues indefinitely.

Sound Level Measurement

The last bin in an octave display shows one of many types of sound level measurement.

Leq

Leq exponential time averaged power is computed according to ANSI S1.4-1983. It is computed from real-time low-pass filtered input data, not from the octave band outputs. The bandwidth of Leq is DC-100kHz for 1 octave channel and DC-50kHz for 2 channels.

To measure Leq, set the Averaging Type to Exponential and the Power Bin to L.

When the Averaging Type is Exponential or Linear, the exponential time constant for Leq is the Integration Time. Leq power is always an exponential average and continues to change even after a linear average is complete.

Standard measurements use either 125 ms (Fast) or 1000 ms (Slow). Note that the lowest octave band places a limit on the averaging time. The standard time constants may not be available if the octave measurement extends to low frequency bands. If the Averaging Type is Equal Confidence, Leq has the same confidence level as the octave measurement. If the Averaging Type is Peak Hold, Leq is not available.

The last bin in the measurement displays the Leq sound level. The last bin is labeled either 'L' (for uniform weighting) or 'LA' (if the input A-Weighting filter is on).

In a User Math function, the L or LA bin is treated the same as the other octave bins, with the exception of the A, B and C weighting operators. These operators do not change the L or LA bin.

Impulse

Broadband Impulse sound level (I) is computed according to IEC 651-1979, Type 0. It is computed from real-time low-pass filtered input data, not from the octave band outputs. The Impulse bandwidth is DC-100kHz for 1 octave channel and DC-50kHz for 2 channels.

To measure I, set the Averaging Type to Exponential, Linear or Equal Confidence and the Power Bin to Impulse.

The time constants for the Impulse measurement are defined by the IEC standard. The Integration Time and Confidence Level are ignored by the Impulse calculation. Impulse power is always an exponential average and continues to change even after a linear average is complete.

The last bin in the measurement displays the Impulse sound level. The last bin is labeled 'I'.

In a User Math function, the I bin is treated the same as the other octave bins, with the exception of the A, B and C weighting operators. These operators do not change the I bin.

Peak

Broadband Peak sound level (P) is computed according to IEC 651-1979, Type 0. It is computed from real-time low-pass filtered input data, not from the octave band outputs. The Peak bandwidth is DC-100kHz for 1 octave channel and DC-50kHz for 2 channels.

To measure P, set the Averaging Type Peak Hold. In this case, the Power Bin must be set to Peak.

The time constants for the Peak measurement are defined by the IEC standard. The Integration Time and Confidence Level are ignored by the Peak calculation. Peak power is always an exponential average and continues to change even after a linear average is complete.

The last bin in the measurement displays the Peak sound level. The last bin is labeled 'P'.

In a User Math function, the P bin is treated the same as the other octave bins, with the exception of the A, B and C weighting operators. These operators do not change the P bin.

Total Power

Total power (T) is computed from the sum of the measured octave bands. The bandwidth is set by the Highest and Lowest Bands of the octave measurement.

To measure Total Power, set the Power Bin to T. Total Power is available for all Averaging Types.

The last bin in the measurement displays the Total Power. The last bin is labeled as follows.

<u>Label</u>	<u>Frequency Weighting</u>
T	uniform weighting
TA	A-Wt (input filter)
Ta	A-Wt (User Math)
Tb	B-Wt (User Math)
Tc	C-Wt (User Math)
Tu	undefined

'Tu' is shown whenever more than one type of weighting exists in the measurement.

In a User Math function, the octave bins are operated on and then summed to provide the T bin. The T bin is computed after the function is evaluated.

Settling Time

When an octave measurement or input is changed, a settling time is required for the change to propagate through the octave filters and the measurement becomes valid again. This settling time is $1/(5 \times \text{bandwidth})$ for each band in the measurement.

The bandwidth of an octave filter is given by

$$\text{Bandwidth} = \text{Center Frequency} \times \left[2^{\frac{1}{2^n}} - \frac{1}{2^{\frac{1}{2^n}}} \right] \quad \text{where } n = 1, 3 \text{ or } 12 \text{ (octave)}$$

'Settle' is shown below the graph while settling takes place. Bands which are un-settled are displayed at half intensity in the graph.

Swept Sine Measurements

A swept sine measurement is basically a sine sweep which steps through a specified sequence of frequency points. At each point, the source maintains a constant frequency and the inputs measure signals only at this frequency. After each measurement point is complete, the source then moves to the next point in the sequence. Unlike the FFT which measures many frequencies at the same time, a swept sine source measures the frequency response a single frequency at a time.

Why Use Swept Sine?

Transfer function can be measured using the FFT. However, if the transfer function has a large variation within the measurement span, then the FFT may not be the best measurement technique. Its limitation comes from the nature of the chirp source that must be used. The FFT measures the response at all frequencies within the span simultaneously, thus the source must contain energy at all of the measured frequencies. In the time record, the frequency components in the source add up and the peak source amplitude within the time record generally exceeds the amplitude of each frequency component by about 30 dB. Since the input range must be set to accommodate the amplitude peak, each component is measured at -30 dB relative to full scale. This effectively reduces the dynamic range of the measurement by about 30 dB! If the transfer function has a variation from 0 to -100 dB within the measurement span, then each bin of the FFT must measure signals from -30 dBfs to -130 dBfs. Even with a large number of vector averages, this proves difficult, especially with large measurement spans.

Swept sine measurements, on the other hand, can optimize the measurement at *each frequency point*. Since the source is a sine wave, all of the source energy is concentrated at a single frequency, eliminating the 30 dB chirp dynamic range penalty. In addition, if the transfer response drops to -100 dBV, the input range of Channel 2 can auto range to -50 dBV and maintain almost 100 dB of signal to noise. In fact, simply optimizing the input range at each frequency can extend the dynamic range of the measurement to beyond 140 dB!

For transfer functions with both gain and attenuation, the source amplitude can be optimized at each frequency. Reducing the source level at frequencies where there is gain prevents overloads and increasing the amplitude where there is attenuation preserves signal to noise. To optimize the measurement time of sweeps covering orders of magnitude in frequency, the detection bandwidth can be set as a function of frequency. More time can be spent at lower frequencies and less time at higher frequencies. In addition, frequency points can be skipped in regions where the response does not change significantly from point to point. This speeds measurements of narrow response functions.

The figure below illustrates the difference between FFT and swept sine when measuring the transfer function of an elliptic low-pass filter. This filter has a stop band of -80 dB and a zero of about -100 dB. The 400 point FFT measurement was made with 2500 vector averages taking about 10 seconds to complete. The swept sine also took 400 points. Each point was averaged for 16 ms or 10 cycles, whichever was longer. The entire sweep also takes about 12 seconds.

2-42 Swept Sine Measurements

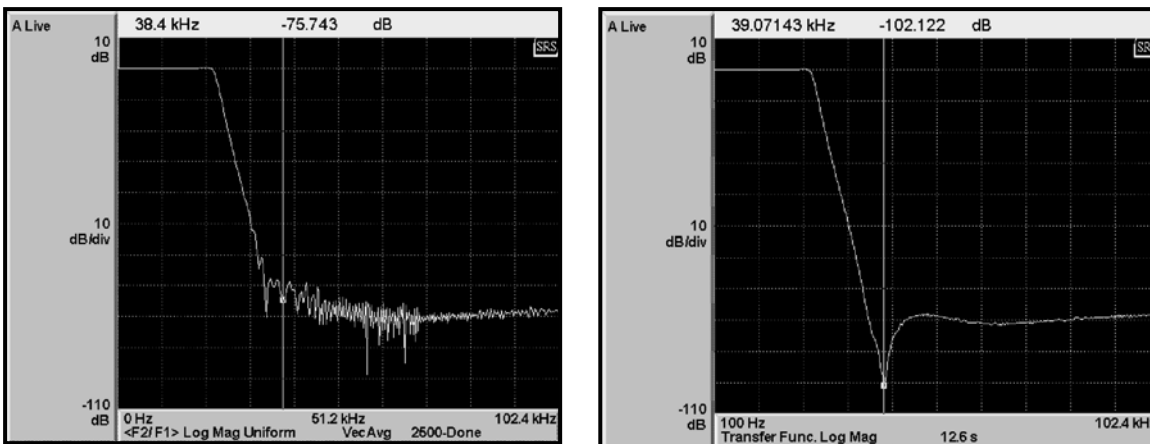

FFT Measurement

Swept Sine Measurement

Figure Chapter 2 -2 Transfer Functions

The range of the FFT measurement is limited to about 80 dB. This is because the response signal to Channel 2 contains frequency components within the filter pass band. These components add to create amplitude peaks near 0 dBV (for a 1V chirp amplitude). This requires the input range of Channel 2 to be set near 0 dBV even though each pass band component is only at -30 dBV. The noise floor at full span is about -100 dBV. Thus, the dynamic range of this measurement is roughly 70 dB (pass band to noise floor). Vector averaging in this case improves the dynamic range to about 80 dB.

The swept sine sweep measures each frequency alone, thus optimizing each frequency point individually. This measurement was taken using Auto Range to adjust the input range at each frequency for the best signal to noise. When the frequency is in the stop band, the return signal to Channel 2 is -80 dBV (or less). The input range of Channel 2 is adjusted to -50 dBV for these frequencies eliminating the noise floor limitation. The depth of the zero in the response as well as the shape of the stop band are clearly resolved.

Swept Sine Measurement Setup

The advantages of the swept sine are apparent in the above comparison. The real usefulness of this technique is that all of the optimizations can be automated in the SR780.

To make a swept sine measurement, select Swept Sine as the Measurement Group. This makes both displays swept sine measurements. Capture and Waterfall are unavailable in the Swept Sine group.

The sweep frequency parameters are set in the [Frequency] menu. The settling and integration time for each point is set in the [Average] menu. The source amplitude is set in the [Source] menu.

Simply press the [Auto Range Ch1] and [Auto Range Ch2] keys to turn on Auto Ranging. Auto Ranging always tracks the input signals during a swept sine measurement.

The signal connections are the same as for an FFT transfer function. The SR780 measures Channel 2 response divided by Channel 1 as the transfer function. The input to the device under test is measured by Channel 1 (typically this is the source output) and the device output is measured by Channel 2.

Swept sine displays differ from FFT displays. The sweep span is not limited to factors of two and the start and stop frequencies are not related to an FFT span. Also, the number of points can range from 10 to 2047. Y axis scaling and X axis zooming are the same as with FFT displays.

Each data point is graphed at its correct frequency and amplitude and connected to adjacent points with a line. The marker only moves to the actual sweep points and the Marker Position Bar shows the actual frequency of each point. If the marker position is displayed with a '?', the point is interpolated from nearby measured points. The actual measurement of these points was skipped due to sweep Auto Resolution.

While a sweep is in progress, a small triangular marker moves across the bottom of the display to show the current sweep point. The current frequency is displayed at the top of the screen.

Swept Sine Measurements

Only Spectrum, Cross Spectrum, Transfer Function and User Function measurements are available. Time record, capture and waterfall are not available in this measurement group.

Spectrum

The swept sine spectrum is simply the measurement of a single channel over a sweep. The spectrum is complex (it contains phase and amplitude information). The phase is relative to the source and is stable but arbitrary. Single channel phase is not generally meaningful.

The spectrum measures the actual signal level at the inputs. If Source Auto Level is On, then the spectrum will tend to be constant. Use Transfer Function to remove the effects of a changing source level.

Cross Spectrum

The swept sine cross spectrum is a two channel measurement defined as

$$\text{Cross Spectrum} = \text{conj}(\text{Spec1}) \cdot \text{Spec2}$$

The cross spectrum contains both magnitude and phase information. The phase is the relative phase (at each frequency) between the two channels.

The magnitude is simply the product of the magnitudes of each spectrum. Frequencies where signal is present in both spectra will have large components in the cross spectrum.

Transfer Function

The swept sine transfer function (sometimes called frequency response) is a two channel measurement defined as

$$\text{Transfer Function} = \text{Spec2} / \text{Spec1}$$

The transfer function contains both magnitude and phase information. The phase is the relative phase (at each frequency) between the two channels.

Transfer function measures the response of a network or device under test. The reference channel (1) measures the signal at the input to the device and the response channel (2) measures the device output. The result is the complex transfer function of the device.

User Function

User Function displays the results of a user defined math function. User Functions defined within the Swept Sine Measurement Group may include swept sine measurement results. Use the [User Math] menu to define a math function.

A User Function may not be selected as the measurement if it uses a Trace which is empty or which contains data taken in a different Measurement Group.

See 'User Math' later in this section for more.

Averaging - Settling and Integration

At each frequency point in a swept sine measurement, the inputs measure the amount of signal at the source frequency. This is done by multiplying the input data by $\sin(\omega t)$ and $\cos(\omega t)$ and averaging the results over an Integration Time. As with the FFT, real (in-phase) and imaginary (quadrature) signals are measured yielding both magnitude and phase transfer functions.

The Integration Time is always an exact number of cycles at the source frequency. This rejects signals which are at a different frequency, such as noise and harmonics. A long Integration Time results in a narrow detection bandwidth at the source frequency. This improves signal to noise at the cost of longer measurement times. This is similar to the linewidth of an FFT. However, in the FFT the linewidth is exactly related to the frequency span (Span/FFT Resolution). In swept sine, the Integration Time is independent of the frequency span. Thus, wide spans can be measured with narrow linewidths.

The Integration Time is specified in both time and cycles of the source. Times are converted to the next larger exact number of cycles. The larger of the two specifications is used as the Integration Time. A minimum of 1 cycle or 15.6 ms is always measured. To measure each point with the same linewidth, set the Integration Cycles to 1 and the Integration Time to $1/\text{linewidth}$. To measure each point for a time inversely proportional to the frequency, set the Integration Time to 15.6 ms and the Integration Cycles to the desired number. Remember, the detection bandwidth increases with frequency in this case (the cycles get shorter) which may result in increased detected noise at higher frequencies.

When the integration is complete, the source moves to the next frequency in the sweep. A Settle Time is allowed to pass before any measurement is made at the inputs. This allows the device under test to respond to the frequency change. This can be especially important if the device under test has a high Q. The Settle Time is also specified in both time and cycles of the source. Times are converted to cycles and the larger of the two specified cycles is used.

The Integration and Settle Times are set within the [Average] menu.

Sweep Frequency and Auto Resolution

The span of a swept sine sweep is determined by the Start and Stop frequencies. The entire 102.4 kHz frequency range of the SR780 is available for swept sine measurements. Note that starting a sweep at DC is not possible. In fact, beware of starting at any frequency much less than 1 Hz since the Settle and Integration times are always a minimum of 1 cycle. If the start frequency is very low, the first point can take longer to measure than the entire remainder of the sweep!

The Sweep Number Of Points, or resolution, can be set from 10 to 2047. The points can be in a linear or a logarithmic progression. In many cases it is desirable to sweep over a wide frequency range while still detecting narrow features in the response function. An example might be a filter with many zeroes or a narrow notch. In order to resolve the narrow features, a large number of points must be used in the sweep to improve the frequency resolution. However, a large amount of the sweep time will be spent measuring points between the features of interest. This is where Auto Resolution can save measurement time while preserving resolution.

Auto Resolution is specified by three parameters, the Faster Threshold, the Slower Threshold and the Maximum Step Size. As with all frequency parameters, these are set within the [Frequency] menu.

Auto Resolution examines the measurements of successive frequency points. If the newest measurement is within the Faster Threshold of the previous measurement (for BOTH channels), then the sweep will take larger steps, skipping frequency points. Each successive time this threshold is met, the step size is increased until the Maximum Step Size is reached. This speeds up the sweep in regions where the response is flat (varies less than the Faster Threshold).

If a measurement differs from the previous measurement by more than the Slower Threshold (for EITHER channel), then the sweep returns to the previously measured point and moves to the very next frequency point in the sweep (with no skipping). The sweep continues from this point, speeding up if allowed and slowing down when required. This 'fills' in skips in the sweep which vary by more than the Slower Threshold.

Measurements which differ by more than the Faster Threshold (on EITHER channel) but less than the Slower Threshold (on BOTH channels), maintain the present sweep speed. The number of points skipped remains the same in this case.

In order to adjust these parameters appropriately, some knowledge of the transfer function is required. In order to save time, the Faster Threshold must be set to allow some speeding up. Set the Faster Threshold to the desired amplitude resolution remembering that some sacrifice is required to save time. In order to avoid missing the major features in the response, set the Slower Threshold to less than half of the feature size. If the feature is narrow, set the Maximum Step Size to less than half of the feature width (in sweep points).

It is good practice to start by taking a sweep with Auto Resolution Off. This ensures that the span and resolution of the sweep are correct as well as the averaging times. Once these have been established, turn Auto Resolution On to save time on successive measurements. Start by setting the Faster Threshold to something greater than the

variations of the flat regions of little interest. Set the Slower Threshold to twice the Faster Threshold and the Maximum Step Size to no more than 5% of the Sweep Number Of Points. Adjust the parameters as necessary to optimize the sweeps where needed.

A well specified Auto Resolution sweep can take 80% off of the sweep time while preserving the essential features of the transfer function. This is very useful in repetitive measurements.

Input Auto Ranging

Input auto ranging has the largest impact on extending the dynamic range of a swept sine measurement. It is also the simplest optimization to setup and use. Simply press the [Auto Range] keys to turn on Auto Ranging. Auto Ranging always tracks the input signals during a swept sine measurement. At each frequency point, each input range is adjusted to keep the signal within -6 dB of full scale (if possible). If the input is overloaded, then the range is increased until the overload is removed.

Auto Ranging increases the measurement times whenever an input range is changed. This is especially true when the signal drops below -6 dBfs. In order to detect this under-range condition, the measurement must be made for the entire integration time. At low frequencies, this can add a significant amount of sweep time. Overloads can be detected at any time during the integration time and thus ranging up requires less time.

For smooth transfer functions where successive measurement points do not differ by more than 6 dB, auto ranging does not add substantially to the sweep time while increasing the dynamic range dramatically. In some cases, especially at very low frequencies, it might be better to set the range manually to avoid increasing an already long sweep time.

Auto Ranging is set for each channel separately and can be turned on and off during the sweep. The manual input range can be changed at any time during the sweep as well.

Source Auto Level and Ramping

The source amplitude parameters for a swept sine measurement are set within the [Source] menu. Normally the source amplitude is maintained at a constant level at all frequencies during the sweep. This usually works best for transfer functions which are mostly attenuating and have little or no gain. Simply set the source amplitude such that the device under test is not overloaded anywhere in the sweep.

Source Auto Level will adjust the source amplitude to maintain a constant level, called the Ideal Reference, at the Channel 1 or Channel 2 input. This is useful whenever the transfer function has substantial gain as well as attenuation. Suppose the transfer function of the device under test has +30 dB of gain at one point and -80 dB of loss at another point and overloads at an input or an output of 1.0 V. If a constant source level is used, it must be set to avoid overload during the gain portion of the sweep. This requires a level of -30 dBV. When the sweep reaches the attenuation region, the output signal will drop to -110 dBV. While this is still measurable, it may not be optimum. With Auto Level, the source can try to maintain an Ideal Reference of 1.0 V at the output of the device under test (input of Channel 2) while not exceeding 1.0 V at the device input. Where the gain is +30 dB, the source level is -30 dBV and where the attenuation is -80 dB, the source level increases to the Maximum Source Level (1.0 V in this case). The actual signal output from the device under test varies from 0 dBV to -80 dBV instead of 0 dBV to -110 dBV

in the constant level case. Varying the source level narrows the range of the output signals. This avoids overloads when there is gain and increases the output signal to noise when there is attenuation.

Source Auto Level requires input Auto Ranging to be on. This is because the non-reference channel should follow all of the source changes. In the above example, the source changes by 30 dB at Channel 1.

There are five important parameters to set when using Auto Level. The Auto Level Reference Channel determines which input will be maintained at the reference level. This is usually the device under test output (Channel 2). In cases where the device under test is not driven directly from the source output, the device input (Channel 1) may be the reference. The Ideal Reference is the level the source will try to maintain at the Reference Channel. This is determined by the limitations of the device under test or may simply be the desired signal level at which the test is run. The Maximum Source Level is the largest allowed source amplitude. This is limited by the SR780 source output or the device under test input range. The Reference Upper and Lower limits are the allowable tolerances for the Reference Channel. The source level is changed only if the reference channel measures an input which exceeds the Ideal Reference by more than the Upper Limit or which is less than the Ideal Reference by more than the Lower Limit. In cases where the reference channel input must be limited, the Ideal Reference plus the Upper Limit must be less than or equal to this limit.

Whenever Auto Level is used, the measurement **MUST** be transfer function. The signal connections must be made for a transfer function measurement. This is because source level changes are not normalized in the individual measurements. Only the ratio of Channel 2 to Channel 1 is source level independent.

The Source Ramp Rate is the rate at which the source level changes. If Source Ramping is Off, source level changes are made instantly. If Source Ramping is On, the source level changes are made at the ramp rate. The Settle Time starts after the source reaches the new level. This prevents fast level changes from disturbing the device under test. Of course, this adds to the sweep time.

The source ramps off whenever there are no measurements being made. This occurs before the start of a sweep, at the end of a single sweep or while a sweep is paused (by the user). If Ramping is Off, the source shuts off instantly in these situations.

Trace Storage

Measurement data may be stored in one of 5 Trace buffers. Trace buffers are simply temporary storage for complex measurement results and are shared by all Measurement Groups. Trace data is not retained when the power is turned off.

Display or Reference Display data may be saved to a Trace. Waterfall records or slices may also be saved to a Trace. Trace data is associated with the Measurement Group in which the data was originally taken. A Trace into which an FFT measurement has been saved is associated with the FFT Group.

A stored Trace can be recalled to the active display as Display data. A Trace may be recalled to a display regardless of its associated Measurement Group. When a Trace is recalled as Display data, the Display becomes Off-Line. Since the Off-Line display is showing static trace data, its Measurement, Window, Frequency Span and Averaging may not be modified. Only display related parameters such as View, Scaling and Marker Functions may be changed Off-Line.

A stored Trace can also be recalled to the active display as its Reference Display. In this case the Measurement Group associated with the Trace must be the same as the Measurement Group of the active display (either Live or Off-Line).

A stored Trace may be used as an operand in a User Math Function. In this case, in order to display the User Function, the Trace must contain data AND the Trace must have data stored from within the current Measurement Group. For example, an FFT User Function which uses Trace1 cannot be chosen as a Measurement if Trace1 is empty OR contains octave analysis data.

To preserve Trace data permanently, save the Trace to disk.

A Trace may be recalled from a disk file or loaded from an interface. If a User Function is displayed and it uses a Trace in its equation, then that Trace cannot be changed to data from a different Measurement Group. For example, if an FFT User Function using Trace1 is being displayed, you cannot recall octave data from disk to Trace1.

User Math Functions

What is a User Function?

User Functions are used to define measurements which are not already available in each Measurement Group. A User Function is an equation defined by the user in the [User Math] menu. User Functions use Operands such as FFT(1), FFT(2), Traces or Constants, and Operators such as +, -, x, / as well as FFT(), IFFT(), Avg(), Mag(), Phase(), etc.

To make a measurement of a defined User Function, select the User Function as the Measurement for the active display. User Functions behave exactly the same as the predefined measurements in general. The display will show the measurement results using real time input data (if the function requires input data). Frequency, Averaging and Displays operate normally for most User Functions. Triggering operates normally within each Measurement Group (a function using an FFT time record is triggered normally).

User Functions are saved and recalled to disk with the instrument Settings.

Measurement Groups and Traces

Each Measurement Group contains 5 User Functions in addition to its predefined measurements. User Functions can only be measured (displayed) within their own Measurement Group. Each Measurement Group allows different Operands (FFT(1), Oct(1) or Swept Sine Spec(1)) as well as different Operators.

User Functions can also use the 5 stored Traces as operands. In this case, in order to display this User Function, the Trace must contain data AND the Trace must have data stored from within the current Measurement Group. For example, an FFT User Function which uses Trace1 cannot be chosen as a Measurement if Trace1 is empty OR contains octave analysis data.

If a User Function is displayed and it uses a Trace in its equation, then that Trace cannot be changed to data from a different Measurement Group. For example, if an FFT User Function using Trace1 is being displayed, you cannot recall octave data from disk to Trace1.

Changing Measurement Groups and storing Traces may make User Functions unavailable because of the above restrictions. In this case, store Trace data within the current Measurement Group before selecting the User Function as the measurements.

Units

The measurement of a User Function makes no attempt at assigning units to the result. The results are unitless numbers and the display Units are always Units or dB.

The conversion of units to dB is either $20\log(\text{units})$ or $10\log(\text{units})$ as selected by the dB Conversion assigned to each function.

Input Transducer Units are used in the calculation of User Functions. Operands which use an input with Transducer Units On is scaled by the appropriate EU/V.

Operands

Operands are arrays of complex values (real and imaginary). They may be measurement results (such as FFT(1), Time(1) or Oct(1)), a Trace, or a Constant. An array which is real simply has zero for its imaginary parts. The array length of an Operand is determined by the measurement length (number of FFT lines, length of time record, number of octaves, etc.) or Trace length (length of the data which is stored in the Trace). Constants assume the length of the user function.

Operands which are measurement results, such as FFT(1), Oct(1) or Spec(1) are exactly the same as the normal measurements. They are computed from the input data (real time Analog or capture Playback) and use the frequency and windowing parameters from the menus. Frequency domain measurements are amplitude calibrated, time records are not. FFT and Time record measurements are also triggered just like the normal measurements. Thus, vector averaging can be applied to these operands.

FFT(1) and FFT(2) are the FFT of the Ch1 and Ch2 inputs. These operands use the window chosen in the [Window] menu for the display which is measuring the function.

FFTa(1) is the FFT of the Ch1 input using the window for Display A, regardless of which display is measuring the function. FFTb(2) is the FFT of the Ch2 input using the window for Display B. This allows a function to be defined which uses both input channels, each with a different window. Force-exponential transfer function for example.

FFTu(1) and FFTu(2) are un-windowed FFT's of the Ch1 and Ch2 inputs.

Octave and Swept Sine measurements are always averaged measurements. Use the [Average] menu to set the averaging parameters.

Auto_Corr(1), Auto_Corr(2), X_Corr, $\langle F2 \rangle / \langle F1 \rangle$ and Coherence are all averaged FFT measurements, regardless of whether averaging is On or Off in the [Average] menu. The Averaging Mode is determined by the definition of the measurement. The Averaging Type (linear or expo) and the Number of Averages are set in the [Average] menu.

FFT, Time, X_Spec and FFT2/FFT1 are NOT averaged measurements. Use the Avg() or VecAvg() operators to perform explicit averaging on these operands.

Trace operands are simply the static data stored in the Traces. For example, Traces can hold reference data used for normalization or calibration. There are 5 Traces which can be stored. These Traces are shared by all 3 Measurement Groups.

Constants are complex constants which are the same for every array point. Constants such as pi are commonly used in equations. There are 5 constants which can be defined. These constants are shared by all 3 Measurement Groups.

X Axis

Operands have an X axis type (frequency or time) as well as an X axis (array) length. The X axis type of the User Function determines the X axis labeling of its display.

In general, the length of a User Function is determined by the length of the longest operand array. Operations between operand arrays are performed on a point by point basis, starting at the beginning of each array. Operands of different lengths (400 point

FFT1 and 800 point FFT1 stored in a Trace) can be combined in an User Function. The math is performed over the longest operand with the shorter operand array being used in a circular fashion. This usually leads to meaningless results.

Measurement operands (FFT(1), Time(1), etc.) and Traces have an X axis type, either frequency or time domain. Arrays of frequency data start at the lowest frequency. Arrays of time data start at time=0. A frequency domain operand (FFT(1)) can be added to a time domain operand (Time(1)) point by point even though the result is meaningless. The X axis type of a User Function is determined by examining its equation from left to right and keeping track of domain switching (IFFT and FFT) operations. Operand terms with an incompatible X axis type have no effect on the function's X axis type, though the entire equation is still evaluated.

Constants are simply constant for each point. They also have no effect on the function's X axis type. If a User Function is defined simply in terms of constants (no other operands), then the X axis type defaults to frequency.

If a User Function's X axis type or length is determined by a Trace, then changing the data in the Trace may change the function's X axis type or length as well.

Operations

Operands are combined with Operations to define a function.

Arithmetic operations (+, -, x, /) combine operand terms on a point by point basis. It is the user's responsibility to ensure that the operand terms have the correct X axis type and lengths required to produce meaningful results.

View operations (Mag(), Mag²(), Phase(), Real(), Imag()) simply convert the complex operand array into the desired form. Mag() and Mag²() compute the magnitude ($\sqrt{x^2 + y^2}$) or magnitude squared ($x^2 + y^2$) with a real result. Phase() computes the phase ($\tan^{-1}(y/x)$) unwrapped with a real result. Real() simply zeroes the imaginary part. Imag() copies the imaginary part to the real part and then zeroes the imaginary part.

Conj(), Ln(), Exp() and Sqrt() are defined as follows,

$$\begin{aligned} \text{Conj}(x + jy) &= x - jy \\ \text{Conj}(x - jy) &= x + jy \\ \text{Ln}(x + jy) &= \ln(r) + j\theta \\ \text{Exp}(x + jy) &= \exp(x) \cdot (\cos(y) + j\sin(y)) \\ \text{Sqrt}(x + jy) &= \sqrt{r} \cdot (\cos(\theta/2) + j \sin(\theta/2)) \\ [X/(1-X)](x + jy) &= (x + jy)/(1 - x - jy) \end{aligned}$$

where $r = \sqrt{x^2 + y^2}$ and $\theta = \tan^{-1}(y/x)$. Sqrt computes all angles positive from 0. The $[X/(1-X)]()$ operator is generally used on real arguments only.

The $j\Omega$ operator is simply $j\omega$ and zeroes the real part and fills the imaginary part with the value of ω ($2\pi \cdot \text{frequency}$) at each point in the array. The frequency is determined by the span of the operand. A measurement operand (FFT(1) or Time(1)) uses the current frequency span. A Trace operand uses the span of the measurement which is stored in the Trace. The DC (0 Hz) bin is filled with 1/16 of the value of the first point (to avoid divide by zero).

Not all operations are available in all Measurement Groups. Swept Sine and Octave measurements have no time records and thus the FFT() and IFFT() operators are not available. In addition, the results are always averaged so the Avg() and VecAvg() operators are also not required. FFT(), FFTu(), IFFT(), Avg() and VecAvg() are only available in the FFT Measurement Group.

FFT() is the windowed FFT operator. The current window chosen in the [Window] menu is used on the operand before taking the FFT. FFTu() is the un-windowed FFT operator. The uniform window is always used. These operations switch the X axis type. The FFT() and FFTu() operators do not calibrate their results since their operands are not necessarily input time records. To use a calibrated FFT, use the measurement operands FFT(1) or FFT(2).

IFFT() is the inverse complex FFT operation. This operation switches the X axis type.

The Avg() operator performs averaging on the operand. The [Average] menu turns averaging Off/On and selects the Mode, Type and Number of Averages. This operator allows the explicit use of averaging within an FFT User Function. The measurement operands (FFT(1) or FFT(2)) are NOT already averaged. Use Avg() to perform averaging on operands or operand terms (e.g. Avg(FFT(1)) or Avg(FFT(2)/FFT(1))).

The VecAvg() operator always performs vector averaging on the operand. Averaging is performed regardless of the Average Off/On selected in the [Average] menu. The menu still determines the Average Type and Number of Averages.

d/dx() is the derivative operator. The derivative is performed with respect to the X-axis bin number, not the x-axis values. For example, to convert d/dx() to d/df() for a linear frequency display, divide by the frequency spacing of the bins. In the case where the X-axis is logarithmic, the function needs to correct for $d(\log x)/dx$. The d/dx() operator requires a smoothing aperture or window.

GrpDly() is the group delay operator. Group delay is simply $d\theta/d\omega$. Use [Display Options]<d/dx Window> to set the aperture. This operator yields valid results for any complex operand which has a frequency x-axis.

AWt() is the A-Weighting operator. This filter is a software version of the input A-Weight filter. BWt() and CWt() are the software B-Weighting and C-Weighting operators. The AWt(), BWt(), and CWt() operators should only be used on operands with a frequency x-axis. All three filters conform to ANSI Standard S1.4-1983.

User Function Limits

User Functions and Constants are defined in the [User Math] menu. Only the 5 functions within the current Measurement Group are available for editing in this menu.

Editing a function which is currently being displayed is allowed. In this case, Traces which do not contain compatible measurements are not allowed as operands.

User Functions have a maximum length of 31 operators plus operands. User Functions cannot use another User Function as an operand.

The use of Avg() or VecAvg() operators uses up extra array storage. A function can generally use 6 to 8 average operators before running into the memory limit.

Displaying a very complex function can increase the processing time required to compute the measurement. In the FFT Group this may cause the measurement to run out of real time (Real Time Indicator > 100%). In this case, input data will be missed. In the Octave Group, this means that the measurement may update less often though no input data is missed.

Example Functions

The pre-defined Measurements for each Group are shown as User Functions below. This is a good starting point for defining your own functions.

FFT Group

The pre-defined FFT measurements use the window specified for the display in the [Window] menu (regardless of input channel). With User Math, it is possible to define 2 channel measurements which use a different window for each input channel by using FFTa(1) and FFTb(2) instead of FFT(1) and FFT(2).

FFTN = Avg(FFT(N))

TimeN = Time(N)

WinTimeN = Time(N) x Trace(Window) (800 line baseband FFT only!)
use [Window]<Window to Trace> to store the window in a Trace.

Cross Spec = Avg(Conj(FFT(1)) x FFT(2))

<F2/F1> = Avg(FFT(2) / FFT(1))

<F2>/<F1> = Avg(FFT(2)) / Avg(FFT(1))

Orbit = Real(Time1) + j*Real(Time2)
use Nyquist View.

Coherence = $\frac{\text{Mag}^2(\text{VecAvg}(\text{Conj}(\text{FFT}(1)) \times \text{FFT}(2)))}{[\text{Mag}^2(\text{Avg}(\text{FFT}(1))) \times \text{Mag}^2(\text{Avg}(\text{FFT}(2)))]}$
Averaging must be On and set to RMS Mode.

Auto CorrN = No averaging:
IFFT(FFTu(N) x Conj(FFT(N)))
Peak Hold or RMS averaging:
IFFT(VecAvg(FFTu(N) x Conj(FFT(N))))
Vector averaging:
IFFT(VecAvg(FFTu(N)) x Conj(VecAvg(FFT(N))))
In all cases, the VecAvg is always performed.

Cross Corr = No averaging:
 IFFT(FFTu(2) x Conj(FFT(1)))
 Peak Hold or RMS averaging:
 IFFT(VecAvg(FFTu(2) x Conj(FFT(1))))
 Vector averaging:
 IFFT(VecAvg(FFTu(2)) x Conj(VecAvg(FFT(1))))
 In all cases, the VecAvg is always performed.

Octave Group

OctN = Oct(N)

Swept Sine Group

SpecN = Spec(N)

Cross Spec = Conj(Spec(1)) x Spec(2)

Trans Func = Spec(2) / Spec(1)

Signal Inputs

The Input Range on the SR780 varies from a maximum of 34 dBV full scale to a minimum of -50 dBV full scale. A signal which exceeds the current input range will cause the OverLoad indicator to appear at the top of the screen. A signal which exceeds the maximum safe range (35 dBVpk) will turn on the Hi V indicator and set the range to 34 dBV.

The Input Range is displayed in dBV. The maximum and minimum range equivalents are tabulated below.

Max	34 dBVpk 31 dBVrms 50.1 Vpk 35.4 Vrms
Min	-50 dBVpk -53 dBVrms 3.16 mVpk 2.24 mVrms

Manual Range

The fixed Input Range is specified in the [Input] menu. Signals that exceed the range will overload and become distorted. Signals which fall to a small percentage of the range will lose dynamic range.

Auto Range

The Input Range can be set to automatically correct for signal variations. Use the [Auto Range Ch1] and [Auto Range Ch2] keys to toggle Auto Ranging On and Off. Specify either Normal or Tracking Auto Range in the [Input] menu.

When Normal Auto Ranging is On and an overload occurs, the Input Range is increased so that the signal no longer overloads. If the signal decreases, the input range is not adjusted. You must take care to ensure that the signal does not fall dramatically after pushing the Input Range to a very (high) insensitive setting.

Tracking Auto Range moves the Input Range up when an overload occurs and down when the signal falls below half full scale.

Auto Range is always Tracking for swept sine measurements.

Input Noise

Noise measurements in FFT analyzers are usually made using Power Spectral Density (PSD) units. PSD units simply normalize the amplitude of each frequency bin by the square root of the linewidth. A window correction factor is also included to compensate for the bandwidth of the different windows. PSD units have the form V_{rms}/\sqrt{Hz} or dBV_{rms}/\sqrt{Hz} .

Most noise sources, including the amplifier input noise, are Gaussian in nature. The amount of noise is proportional to the square root of the bandwidth in which the noise is

measured. A noise measurement made using normal units would yield different amplitudes depending upon the linewidth of the FFT span. By using PSD units, the measured noise is independent of linewidth and span.

The input noise of the SR780 inputs is about 10 nVrms/ $\sqrt{\text{Hz}}$. The input noise of the analog to digital (A/D) converter is about 300 nVrms/ $\sqrt{\text{Hz}}$ (referenced to a full scale of 1 Vpk). What does this mean in terms of the FFT noise floor?

For input ranges below -30 dBV (input gain greater than 30 dB), the measured noise floor is determined by the signal inputs. This is because the signal gain (>30) times the input noise (10 nVrms/ $\sqrt{\text{Hz}}$) exceeds the input noise of the A/D converter.

For input ranges above -30 dBV (input gain less than 30 dB), the measured noise floor is determined by the A/D converter. There is not enough gain to amplify the input noise to a level greater than the A/D converter itself. The noise floor in this case is 300 nVrms/ $\sqrt{\text{Hz}}$ relative to 1 Vpk or -130 dBpk/ $\sqrt{\text{Hz}}$ relative to full scale.

All of this assumes that the signal input is driven from a low impedance (and noiseless) source. Remember, resistors have a Johnson noise equal to $0.13\sqrt{R}$ nVrms/ $\sqrt{\text{Hz}}$. Even a 50 Ω resistor has almost 1 nVrms/ $\sqrt{\text{Hz}}$ of noise! A signal source impedance of 6 k Ω has a Johnson noise equal to the SR780's input noise. To determine the overall noise of multiple noise sources, take the square root of the sum of the squares of the individual noise figures. For example, a 6 k Ω source impedance has 10 nVrms/ $\sqrt{\text{Hz}}$ of noise. Added to the input noise, the overall noise is $(10^2 + 10^2)^{1/2}$ or 14 nVrms/ $\sqrt{\text{Hz}}$.

Input Impedance

The input impedance of the SR780 is 1 M Ω . If a higher input impedance is desired, then the SR550 remote preamplifier must be used. The SR550 has an input impedance of 100 M Ω and is AC coupled above 1 Hz.

Anti-aliasing Filter

After all of the signal amplification, there is an anti-aliasing filter. This filter is required by the signal digitization process. According to the Nyquist criterion, signals must be sampled at a frequency at least twice the highest signal frequency. In this case, the highest signal frequency is 102.4 kHz and the sampling frequency is 262 kHz so things are ok. However, no signals above 131 kHz can be allowed to reach the A/D converter. These signals would violate the Nyquist criterion and be undersampled. The result of this undersampling is to make these higher frequency signals appear as lower frequencies in the digital data stream. Thus a signal at 175 kHz would appear below 102.4 kHz in the digital data stream and be detected in the spectrum.

To avoid this undersampling, the analog signal is filtered to remove any signals above 160 kHz (when sampling at 262 kHz, signals above 160 kHz will appear below 102 kHz). This filter has a flat pass band from DC to 104 kHz so as not to affect measurements in the operating range of the analyzer. The filter rolls off from 104 kHz to 160 kHz and achieves an attenuation above 160 kHz of at least 90 dB. Amplitude variations and phase shifts due to this filter are calibrated out at the factory and do not affect frequency domain measurements.

For time domain measurements, the anti-aliasing filter limits the rise time of the signal and causes ringing. To eliminate these effects in the time record, the anti-aliasing filter

can be removed from the signal path. However, the spectrum of this time record may contain alias frequencies.

A-Weighting Filter

The A-Weighting filter may be inserted after the anti-aliasing filter. The A-Weighting filter simulates the hearing response of the human ear and is often used with Octave Analysis measurements. The input A-Weighting filter conforms to ANSI standard S1.4-1983.

A-, B- and C- Weighting functions are also available as operators in User Math functions.

Input Transducer Units

Transducers (such as accelerometers or microphones) convert a physical quantity (such as acceleration or pressure) into a voltage at the analyzer's input. By assigning Transducer Units to an input, measurements based upon the transducer signal may be displayed in units of the actual physical quantity being measured (such as m/s^2 or Pascals).

Transducer Units require a transducer which is linear over the frequency range of interest.

Measurements of inputs which are assigned units of acceleration, velocity or displacement may be displayed with any of these three units using Transducer Convert in the [Display Options] menu.

Input Connections

In order to achieve the best accuracy for a given measurement, care must be taken to minimize the various noise sources which can be found in the laboratory. With intrinsic noise (Johnson noise, 1/f noise or input noise), the signal source must be designed with these noise sources in mind. These noise sources are present regardless of the input connections. The effect of noise sources in the laboratory (such as motors, signal generators, etc.) and the problem of differential grounds between the signal source and the analyzer can be minimized by careful input connections.

There are two basic methods for connecting a voltage signal to the analyzer - the single-ended connection is more convenient while the differential connection eliminates spurious pick-up more effectively.

Single-Ended Connection (A)

In the first method, the analyzer uses the A input in a single-ended mode. The analyzer detects the signal as the voltage between the center and outer conductors of the A input only. The analyzer does not force the shield of the A cable to ground, rather it is internally connected to the analyzer's ground via a resistor. The value of this resistor is selected by the user. Float uses 1 M Ω and Ground uses 50 Ω . This avoids ground loop problems between the signal source and the analyzer due to differing ground potentials. The analyzer lets the shield 'quasi-float' in order to sense the source ground. In general, if the source is floating, use a Grounded input. If the source is grounded, use a Floating input. Do not use a Floating input with a floating source since the shield is simply a noise antenna in this case. Noise pickup on the shield alone will appear as noise to the analyzer. Common mode noise, which appears on both the center and shield, is rejected by the common mode rejection (CMR) of the analyzer input, but noise on the shield only is not rejected at all.

Differential Connection (A-B)

The second method of connection is the differential mode. The analyzer measures the voltage difference between the center conductors of the A and B inputs. Both of the signal connections are shielded from spurious pick-up. Noise pickup on the shields does not translate into signal noise since the shields are ignored. The shields in this case are grounded by 50 Ω since they are being used as signal shields.

When using two cables, it is important that both cables travel the same path between the signal source and the analyzer. Specifically, there should not be a large loop area enclosed by the two cables. Large loop areas are susceptible to magnetic pickup.

Common Mode Signals

Common mode signals are those signals which appear equally on both center and shield (A) or both A and B (A-B). With either connection scheme, it is important to minimize both the common mode noise and the common mode signal. If the signal source floats at a non-zero potential, the signal which appears on both the A and B inputs will not be perfectly canceled. The common mode rejection ratio (CMRR) specifies the degree of cancellation. For low frequencies, the CMRR of 90 dB indicates that the common mode signal is canceled to 1 part in 30,000. Even with a CMRR of 90 dB, a 1 V common mode signal behaves like a 3 μ V differential signal! The CMRR decreases by about 6 dB/octave (20 dB/decade) starting at around 1 kHz.

AC vs DC Coupling

The signal input can be either AC or DC coupled. The AC coupling high pass filter passes signals above 160 mHz (0.16 Hz) and attenuates signals at lower frequencies. AC coupling should be used at frequencies above 160 mHz whenever possible. At lower frequencies, DC coupling is required.

For small signals it is common that the DC offset of the signal exceeds the amplitude of the AC signal of interest. In this case, the input range may be limited to accommodate the large DC offset while sacrificing signal to noise in the measurement of the AC signal. If the signal frequency exceeds 0.16 Hz, use AC coupling if possible.

Intrinsic (Random) Noise Sources

Random noise finds its way into signals in a variety of ways. Good test design can reduce these noise sources and improve the measurement stability and accuracy.

There are a variety of intrinsic noise sources which are present in all electronic signals. These sources are physical in origin.

Johnson Noise

Every resistor generates a noise voltage across its terminals due to thermal fluctuations in the electron density within the resistor itself. These fluctuations give rise to an open-circuit noise voltage,

$$V_{\text{noise}} (\text{rms}) = (4kTR\Delta f)^{1/2}$$

where k =Boltzmann's constant (1.38×10^{-23} J/°K), T is the temperature in °Kelvin (typically 300°K), R is the resistance in Ohms, and Δf is the bandwidth in Hz. Δf is the bandwidth of the measurement (usually the FFT linewidth).

Shot Noise

Electric current has noise due to the finite nature of the charge carriers. There is always some non-uniformity in the electron flow which generates noise in the current. This noise is called shot noise. This can appear as voltage noise when current is passed through a resistor. The shot noise or current noise is given by

$$I_{\text{noise}} (\text{rms}) = (2qI\Delta f)^{1/2}$$

where q is the electron charge (1.6×10^{-19} Coulomb), I is the RMS AC current or DC current depending upon the circuit, and Δf is the bandwidth (usually the FFT linewidth).

1/f Noise

Every 10 Ω resistor, no matter what it is made of, has the same Johnson noise. However, there is excess noise in addition to Johnson noise which arises from fluctuations in resistance due to the current flowing through the resistor. For carbon composition resistors, this is typically 0.1 to 3 μV of rms noise per Volt applied across the resistor. Metal film and wire-wound resistors have about 10 times less noise. This noise has a 1/f spectrum and makes measurements at low frequencies more difficult.

Other sources of 1/f noise include noise found in vacuum tubes and semiconductors.

Total Noise

All of these noise sources are incoherent. The total random noise is the square root of the sum of the squares of all the incoherent noise sources. Thus, the largest noise source easily dominates all others in determining the noise floor of the measurement.

External Noise Sources

In addition to the intrinsic noise sources discussed previously, there are a variety of external noise sources within the laboratory.

Most of these noise sources are asynchronous, i.e. they are not related to the signal and do not occur at the signal frequency or its harmonics. Examples include lighting fixtures, motors, cooling units, radios, computer screens, etc. If these noise sources are large, they can determine the input range and hence the noise floor. They can however be removed from the FFT spectrum by using triggering and vector averaging. Since the noise signals are not phase coherent with the trigger and signals of interest, they vector average to zero.

Some noise sources, however, are related to the signal source and, if picked up in the signal, will add or subtract from the actual signal and cause errors in the measurement. A typical source of synchronous noise is a ground loop between the signal source and the analyzer.

Many of these noise sources can be minimized with good laboratory practice and experiment design. There are several ways in which noise sources are coupled into the signal path.

Capacitive Coupling

An AC voltage from a nearby piece of apparatus can couple to a signal path via a stray capacitance. Although C_{stray} may be very small, the coupled noise may still be larger than a weak signal. This is especially damaging if the coupled noise is synchronous with the signal.

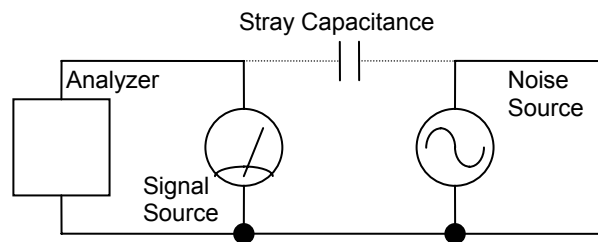

Figure Chapter 2 -3 Capacitive Coupling

We can estimate the noise current caused by a stray capacitance by,

$$i = C_{\text{stray}} dV/dt = \omega C_{\text{stray}} V_{\text{noise}}$$

where ω is 2π times the noise frequency, V_{noise} is the noise amplitude, and C_{stray} is the stray capacitance.

For example, if the noise source is a power circuit, then $f = 60$ Hz and $V_{\text{noise}} = 120$ V. C_{stray} can be estimated using a parallel plate equivalent capacitor. If the capacitance is roughly an area of 1 cm² separated by 10 cm, then C_{stray} is 0.009 pF. The resulting noise current will be 400 pA (at 60 Hz). This small noise current can be larger than the signal current. If the noise source is at a higher frequency, the coupled noise will be even greater.

If the noise source is at the signal frequency, then the problem is much worse. Vector averaging rejects noise at other frequencies, but pick-up at the signal frequency appears as signal!

Cures for capacitive noise coupling include:

- 1) Removing or turning off the noise source.
- 2) Keeping the noise source far from the signal source (reducing C_{stray}). Do not bring the signal cables close to the noise source.
- 3) Designing the experiment to measure voltages with low impedance (noise current generates very little voltage).
- 4) Installing capacitive shielding by placing the signal source in a metal box.

Inductive Coupling

An AC current in a nearby piece of apparatus can couple to the signal path via a magnetic field. A changing current in a nearby circuit gives rise to a changing magnetic field which induces an emf ($d\Phi_B/dt$) in the loop connecting the signal source to the analyzer. This is like a transformer with the analyzer-source loop as the secondary winding.

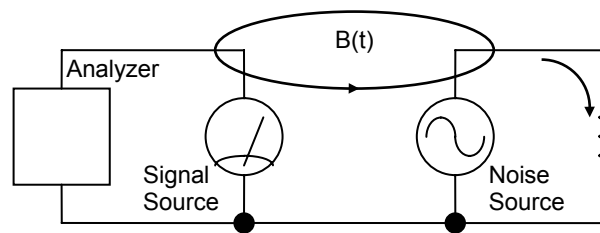

Figure Chapter 2 -4 Inductive Coupling

Cures for inductively coupled noise include:

- 1) Removing or turning off the interfering noise source.
- 2) Reduce the area of the pick-up loop by using twisted pairs or coaxial cables, or even twisting the 2 coaxial cables used in differential connections.
- 3) Using magnetic shielding to prevent the magnetic field from crossing the area of the signal path.
- 4) Measuring currents, not voltages, from high impedance sources.

Resistive Coupling (Ground Loops)

Currents flowing through the ground connections can give rise to noise voltages. This is especially a problem with signal frequency ground currents.

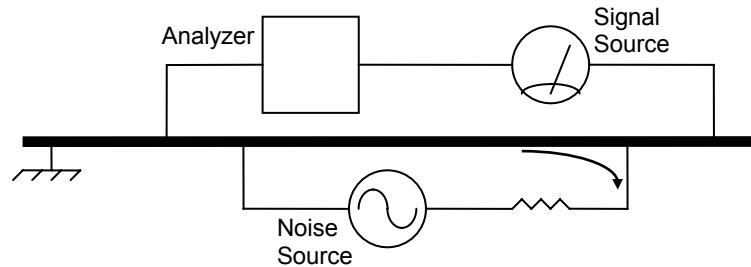

Figure Chapter 2 -5 Resistive Coupling

In this illustration, the analyzer is measuring the signal relative to a ground far from the signal source. The analyzer senses the signal plus the voltage due to the noise source's ground return current passing through the finite resistance of the ground between the analyzer and the source. The analyzer and the source are grounded at different places which, in this case, are at different potentials.

Cures for ground loop problems include:

- 1) Grounding everything to the same physical point.
- 2) Using a heavy ground bus to reduce the resistance of ground connections.
- 3) Removing sources of large ground currents from the ground bus used for small signals.
- 4) Measure the signal relative to the source ground using two cables (A-B). Set the Input Grounding to Float.

Microphonics

Not all sources of noise are electrical in origin. Mechanical noise can be translated into electrical noise by microphonic effects. Physical changes in the signal source or cables (due to vibrations for example) can result in electrical noise over the entire frequency range of the analyzer.

For example, consider a coaxial cable connecting a signal source to the analyzer. The capacitance of the cable is a function of its geometry. Mechanical vibrations in the cable translate into a capacitance that varies in time, typically at the vibration frequency. Since the cable is governed by $Q=CV$, taking the derivative, we have

$$C \, dV/dt + V \, dC/dt = dQ/dt = i$$

Mechanical vibrations in the cable which cause a dC/dt will give rise to a current in the cable. This current affects the measured signal.

Some ways to minimize microphonic signals are:

- 1) Eliminate mechanical vibrations near the signal path.

- 2) Tie down cables carrying sensitive signals so they do not move.
- 3) Use a low noise cable that is designed to reduce microphonic effects.

Thermocouple Effects

The emf created by junctions between dissimilar metals can give rise to many microvolts of slowly varying potentials. This source of noise is typically at very low frequency since the temperature generally changes slowly. This effect is large on the scale of many signals (10^3 's of μV) and can be a problem for low frequency measurements, especially in the mHz range.

Some ways to minimize thermocouple effects are:

- 1) Hold the temperature of the signal source or detector constant.
- 2) Use a compensation junction, i.e. a second junction in reverse polarity which generates an emf to cancel the thermal potential of the first junction. This second junction should be held at the same temperature as the first junction.

Chapter 3

Operation

In This Chapter

Overview	3-3	Analog/Playback	3-18
Power Switch	3-3	Real Time	3-18
Hardware Reset	3-3	Sweep Frequency	3-19
Software Reset	3-4	Capture Progress	3-19
Video Display	3-4	No Cap./Cap. Data	3-19
Keypad	3-4	Link	3-19
Softkeys	3-4	Enter	3-19
Knob	3-5	ALT	3-20
Disk Drive	3-5	GPIB/RS232	3-20
		Comm /Error	3-20
		SRQ	3-20
		Local/Remote/LOCK	3-20
		macro	3-22
Front Panel Connectors	3-6	Keypad	3-23
Ch1 Signal Inputs	3-6	Normal And Alternate Keys	3-23
Ch2 Signal Inputs	3-6	Menu Keys	3-24
Trigger Input	3-6	Entry Keys	3-25
Source Output	3-6	Buttons	3-25
PC Keyboard Connector	3-6	Lists	3-25
		Numeric Values	3-26
Rear Panel Connectors	3-8	Control Keys	3-27
Power Entry Module	3-8	[Start/Reset]	3-27
IEEE-488 Connector	3-9	[Pause/Cont]	3-27
Serial RS232 Connector	3-9	[Start Capture]	3-27
Parallel Printer Connector	3-9	[Stop Capture]	3-28
Preamp Connector	3-9	[Active Display]	3-28
Using SRS Preamps	3-9	[Link]	3-29
		[Print Screen]	3-29
		[Help/Local]	3-29
		[Alt] [Control Key]	3-30
		Play Macro ([Alt] [Start/Reset])	3-30
		Macro Rec ([Alt] [Pause/Cont])	3-30
		End Rec ([Alt] [Stop Capture])	3-30
		Snap Ref ([Alt] [Start Capture])	3-30
		Ref to Trace ([Alt] [Active Display])	3-30
		Trace to Ref ([Alt] [Link])	3-31
		Display to Trace ([Alt] [Print Screen])	3-31
		Trace to Display ([Alt] [Help/Local])	3-31
Screen Display	3-11		
Displays	3-11		
Data Graph	3-12		
Vertical Scale Bar	3-13		
Horizontal Scale Bar	3-14		
Marker	3-14		
Marker Position Bar	3-15		
Active Display	3-15		
Reference Graphs	3-16		
Menu Display	3-16		
Status Indicators	3-17		
Input Ranges	3-17		
OverLoads	3-17		
Input Configurations	3-17		
AWt	3-17		
ArmWait/Trig-wait/Trig/Acquire	3-17		
Run/Pause/Done	3-18		

3-2 Operation

Function Keys	3-32
[Auto Scale A]	3-32
[Auto Scale B]	3-32
[Auto Range Ch1]	3-32
[Auto Range Ch2]	3-33
[Span Up]	3-33
[Span Down]	3-33
[Marker Ref]	3-34
[Display Ref]	3-34
[Marker Center]	3-34
[Marker Max]	3-35
[Marker Min]	3-35
[Show Setup]	3-35
Macros	3-36
Keypad Macros	3-36
Choosing From Lists	3-36
Menus	3-36

Overview

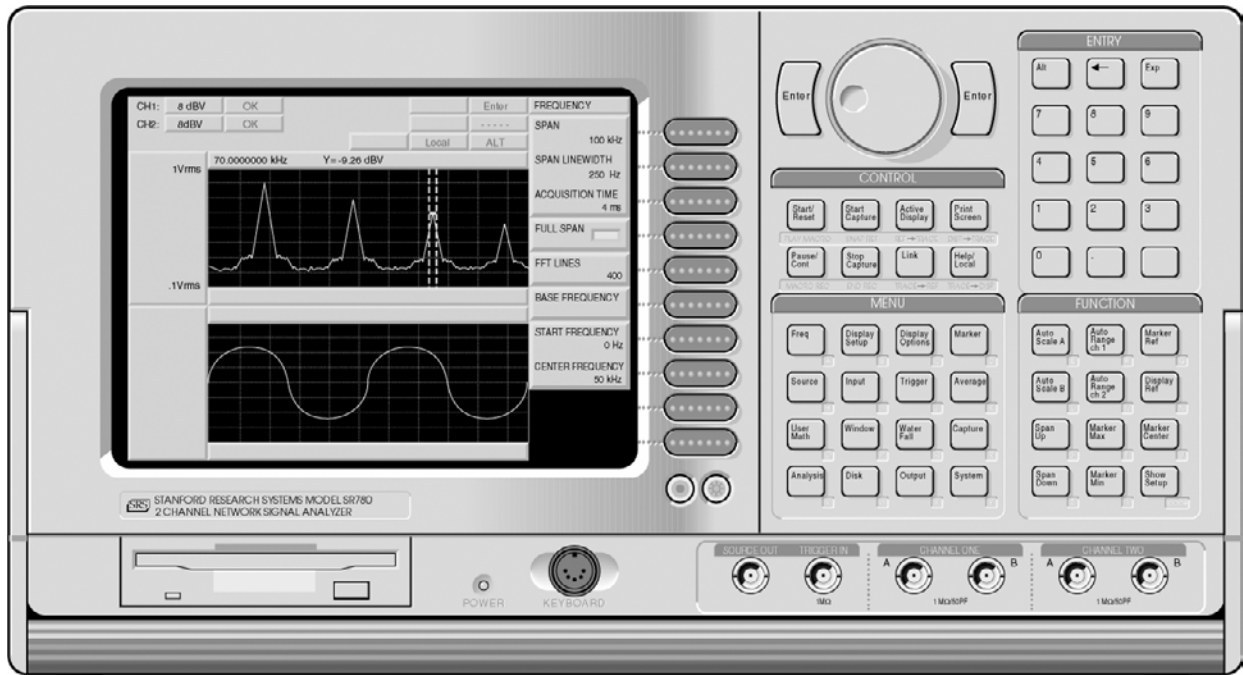

Figure Chapter 3 -1 Front Panel

Power Switch

The power switch is located on the rear panel. The SR780 is turned on by depressing the upper half of the power switch. The green power LED on the front panel indicates that the unit is powered.

The video display may take a few seconds to warm up and become visible. The brightness is adjusted using the [Brighter] and [Dimmer] buttons below the softkeys. The firmware revision, serial number, memory size and calibration dates of the unit are displayed when the power is turned on.

This power on screen may be displayed at any time using [System]<Show Version>.



Caution

This instrument may be damaged if operated with the LINE VOLTAGE SELECTOR set for the wrong AC line voltage or if the wrong fuse is installed.

Hardware Reset

Turn the power on while holding down the backspace [←] key and continue to hold backspace for at least 5 seconds to reset the unit. The unit will perform power on tests and assume the default settings (including the default remote interface settings).

Software Reset

<Preset> in the [System] menu resets the instrument to the default settings. Only the remote interface settings are not changed. All stored data are lost.

This function requires pressing the [Enter] key to confirm.

Video Display

The monochrome video display is the user interface for data display and front panel programming operations. The resolution of the display is 800H by 600V.

The brightness is adjusted using the [Brighter] and [Dimmer] buttons below the softkeys. The contrast is adjusted using [Alt] [Brighter] and [Alt] [Dimmer]. As with most video displays, do not set the brightness higher than necessary. To extend the life of the display, use the Screen Saver in the [System] <Preferences> menu.

A complete description of the screen display follows later in this chapter.

Keypad

The keypad consists of four groups of hardkeys (keys with printed labels).

Hardkeys are referenced in braces like [Active Display] or [Input].

The ENTRY keys are used to enter numeric parameters which have been highlighted by a soft key. The MENU keys select a menu of soft keys. Pressing a menu key will change the menu boxes which are displayed next to the soft keys. Each menu presents a group of similar or related parameters and functions. The CONTROL keys start and stop data acquisition, toggle the active display and link parameters and functions. These keys are not in a menu since they are used frequently and within any menu. The FUNCTION keys perform common functions such as Auto Scale and Auto Range. These keys can be accessed at any time.

A complete description of the keys follows.

Softkeys

The SR780 has a menu driven user interface. The MENU keys each display a menu of softkeys. The softkeys are at the right of the video display and have different functions depending upon the displayed menu.

Softkeys are referenced in brackets like or <Units>.

There are three types of softkeys - buttons, lists and numeric values. A button performs a function, such as <Full Span>. A list presents a list of choices or options in the entry field (at the top of the screen). Use the knob to make a selection and press [Enter].

<Measurement> is an example of a list. A numeric value presents the current value in the entry field and awaits numeric entry. Enter a new value with the ENTRY keys and press [Enter]. <Start Freq> is an example of a numeric value.

A complete description of the menu softkeys follows in the next chapter.

Knob

The knob normally moves the markers within the displays. If a parameter has been highlighted by its softkey, the knob adjusts the parameter. Parameters which have a list of choices are most easily modified with the knob. Numeric entry fields may also be adjusted with the knob.

Disk Drive

The 3.5" disk drive is used to store data and instrument settings. Double sided, high density disks (DS/HD) have a capacity of 1.44M bytes and double sided, double density disks (DS/DD) have a capacity of 720k bytes. The disk format is DOS compatible.

Use the [Disk] menu to format a disk or access disk files.

Front Panel Connectors

Ch1 Signal Inputs

The Channel 1 A and B inputs are voltage inputs with 1 M Ω , 50 pF input impedance. The Input Coupling is either DC or AC. The Input Mode may be single-ended (A) or differential (A-B). The A and B connector shields are common and grounded to the chassis by 1 M Ω + 0.01 μ F (Float) or 50 Ω (Ground). The shields should never exceed ± 4 V.

Do not apply more than ± 50 V to either input. If the input exceeds ± 57 V, the input range will be set to 34 dBV to protect the input from damage and the HighV overload status is set. The input range can not be changed while HighV is detected.

For two channel measurements such as Transfer Function, Channel 1 is the reference input to the device under test.

Ch2 Signal Inputs

The Channel 2 A and B inputs are voltage inputs with 1 M Ω , 50 pF input impedance. The Input Coupling is either DC or AC. The Input Mode may be single-ended (A) or differential (A-B). The A and B connector shields are common and grounded to the chassis by 1 M Ω + 0.01 μ F (Float) or 50 Ω (Ground). The shields should never exceed ± 4 V.

Do not apply more than ± 50 V to either input. If the input exceeds ± 57 V, the input range will be set to 34 dBV to protect the input from damage and the HighV overload status is set. The input range can not be changed while HighV is detected.

For two channel measurements such as Transfer Function, Channel 2 is the response output from the device under test.

Trigger Input

When the Trigger Source is External or Ext TTL, the Trigger input triggers the measurement. The input impedance is 1 M Ω and the minimum pulse width is 25 ns. The Trigger Level is adjustable from -5V to +5V with either Positive or Negative Slope. The minimum trigger amplitude is 100 mV. The trigger input should not exceed ± 5 V.

Source Output

The Source can output either Sine, Two Tone, Chirp, Noise or Arbitrary waveforms. The output impedance is less than 5 Ω and is capable of driving a 50 Ω load. The output is ground referenced.

PC Keyboard Connector

An IBM PC or XT compatible keyboard may be attached to the keyboard connector. Most keyboards have a switch on the back to select PC/XT or 8088 mode. The SR780 can be controlled from this keyboard according to the table below.

<u>SR780 keypad</u>	<u>PC Keyboard equivalent</u>
Softkeys	F1-F10
Menu Keys	Letter shown below the Menu key. (e.g. A to show the Frequency Menu).
Function Keys	Letter shown below the Function key. (e.g. E for AutoScale A).
Control Keys	Alt-1 through Alt-4 (top row) Alt-5 through Alt-8 (bottom row)
Number Keys	0 through 9
Knob (slow)	Left and Right arrow
Knob (fast)	Up and Down arrow
Alt	Escape
Enter	Enter or Return

The keyboard should only be connected when the power is off.

Rear Panel Connectors

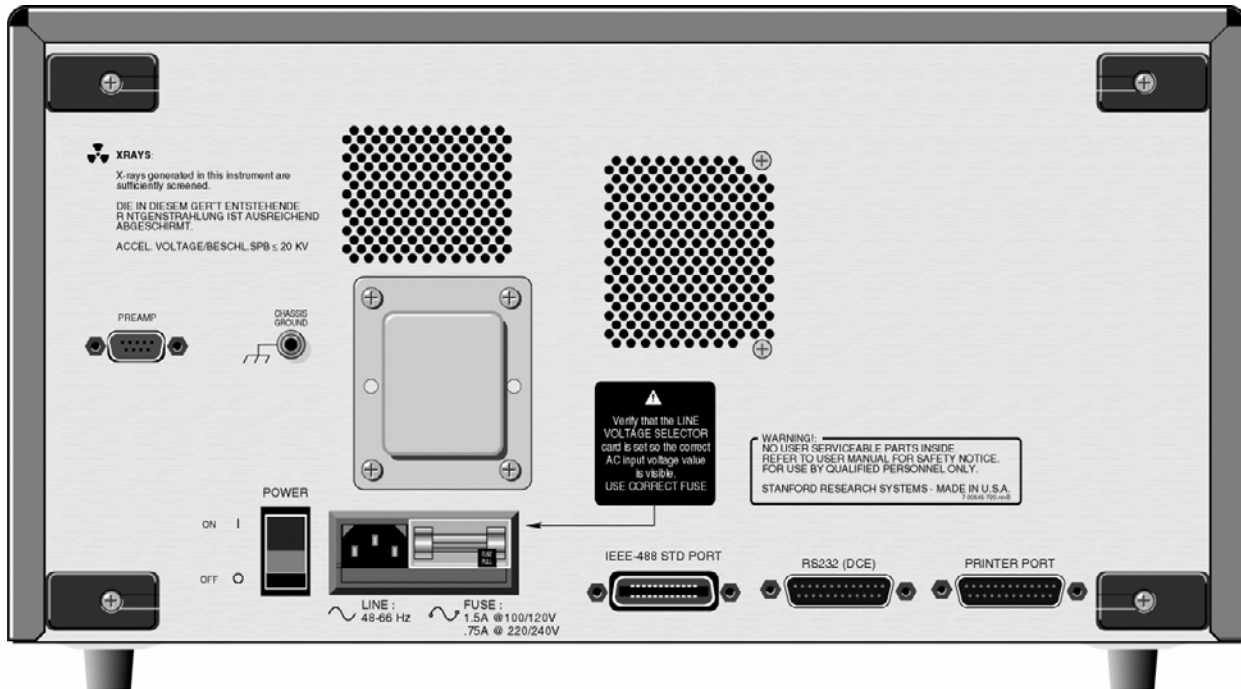

Figure Chapter 3 -2 Rear Panel

Power Entry Module

The power entry module is used to fuse the AC line, select the line voltage, and block high frequency noise from entering or exiting the instrument. The SR780 has a detachable, three-wire power cord for connection to the power source and to protective ground. The exposed metal parts of the instrument are connected to the outlet ground to protect against electrical shock. Always use an outlet which has a properly connected protective ground.



Caution

This instrument may be damaged if operated with the LINE VOLTAGE SELECTOR set for the wrong AC line voltage or if the wrong fuse is installed.

Do not attempt to service or adjust this instrument while it is plugged into a live outlet.

Line Voltage Selection

The SR780 operates from a 100V, 120V, 220V, or 240V nominal AC power source having a line frequency of 50 or 60 Hz. Before connecting the power cord to a power source, verify that the LINE VOLTAGE SELECTOR card, located in the rear panel fuse holder, is set so that the correct AC input voltage value is visible.

Conversion to other AC input voltages requires a change in the fuse holder voltage card position and fuse value. Disconnect the power cord, open the fuse holder cover door and rotate the fuse-pull lever to remove the fuse. Remove the small printed circuit board and select the operating voltage by orienting it so that the desired voltage is visible when

pushed firmly back into its slot. Rotate the fuse-pull lever back into its normal position and insert the correct fuse into the fuse holder.

Line Fuse

Verify that the correct line fuse is installed before connecting the line cord. For 100V/120V, use a 1.5 Amp fuse. For 220V/240V, use a 3/4 Amp fuse.

IEEE-488 Connector

The 24 pin IEEE-488 connector allows a host computer to control the SR780 via the IEEE-488 (GPIB) instrument bus. The GPIB Address of the unit is set in the [System] <Remote> menu.

A GPIB plotter with HPGL compatible graphics may be connected to the IEEE-488 port. In this case, the SR780 will control the plotter to generate plots of the display graphs. Select GPIB as the Output Destination and set the Plotter Address and Type in the [Output] menu.

Serial RS232 Connector

The RS232 interface connector is configured as a DCE (transmit on pin 3, receive on pin 2). The Baud Rate, Parity, and Word Length are set in the [Setup] <Remote> menu. To connect the SR780 to a PC serial adapter, which is usually a DTE, use a straight through serial cable.

A serial plotter or printer may be connected to the RS232 port. Select the Serial interface as the Output Destination and choose the Printer or Plotter Type in the [Output] menu.

Parallel Printer Connector

Attach a parallel printer to the Printer port. Use a standard printer cable. Select the Centronics printer interface as the Output Destination and choose the Printer Type in the [Output] menu.

Preamp Connector

This 9 pin 'D' connector provides power and control signals to external preamplifiers such as the SR550 and SR552. The power connections are described below.

<u>Pin</u>	<u>Voltage</u>
1	+20V
2	+5V
6	-20V
7	Signal Ground
8	Ground

Using SRS Preamps

When using either the SR550 or SR552, connect the power cable (standard 9 pin D connectors) from the preamp to the rear panel Preamp connector. Use BNC cables to connect the A output from the preamp to the A input of either channel on the SR780. The B output from the preamp (preamp ground) may be connected to the B input on the SR780. In this case, use A-B as the Input Mode. Be sure to twist the A and B cables together to reduce noise pick-up.

3-10 Rear Panel Connectors



The SR550 and SR552 are AC coupled above 1 Hz. Do not use either preamp to measure signals below 1 Hz!

The SR780 does not compensate for the gain of the preamp. Both preamps operate at their highest gain. Measurements made by the SR780 need to be divided by the gain of the preamp. The SR550 has a gain of 10 and the SR552 has a gain of 100.

Screen Display

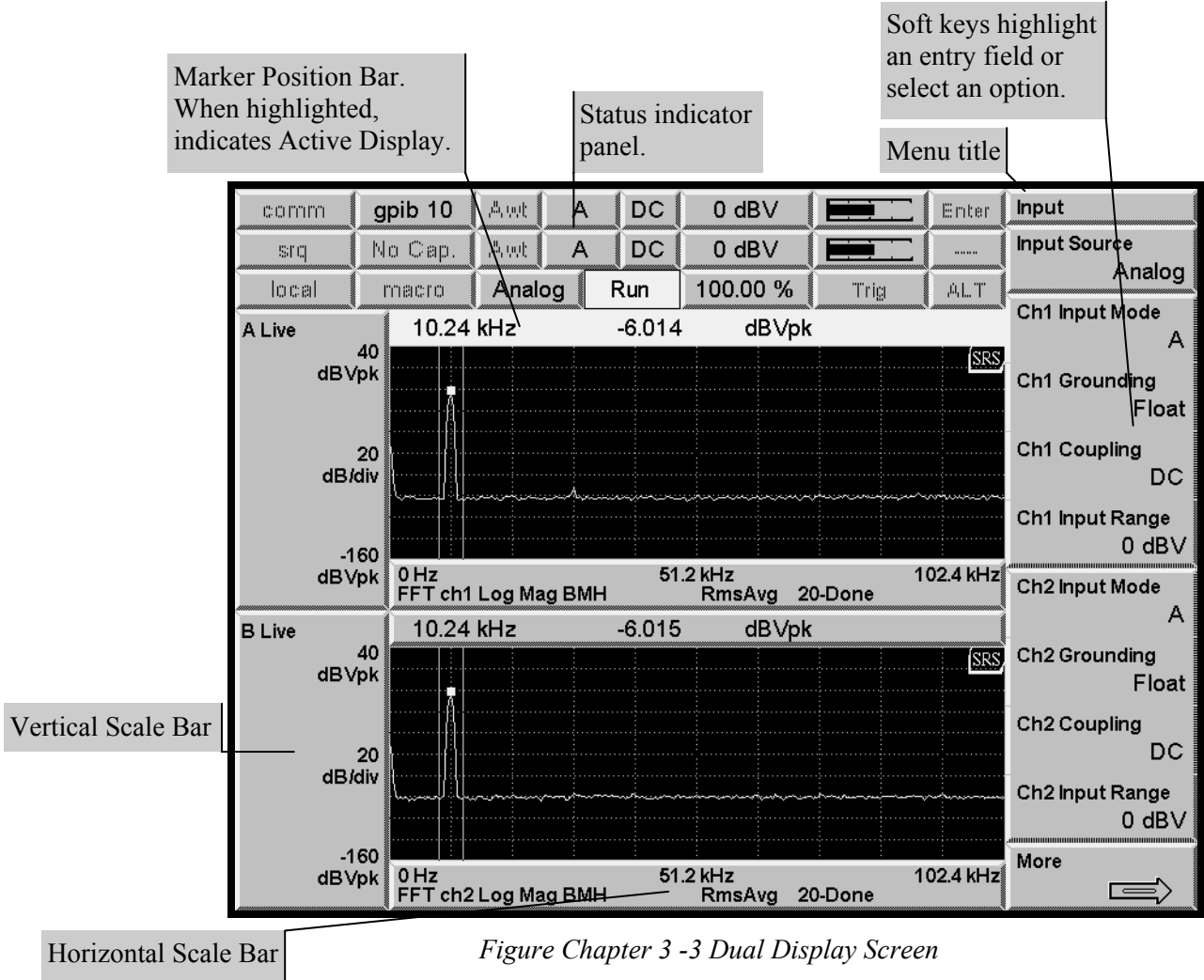

Figure Chapter 3 -3 Dual Display Screen

Displays

There are two displays, labeled DisplayA and DisplayB. Each display consists of a data graph, vertical scale bar, horizontal scale bar and marker position bar.

Each display has an associated measurement. The displays may have different measurements, such as spectrum and time record, different views, such as magnitude and phase, and so on. Many instrument parameters are set independently for each display.

The display format is selected in the [Display Options] menu.

The display shown above is the Dual display format. The [Active Display] key toggles between the two displays. DisplayA is always on top.

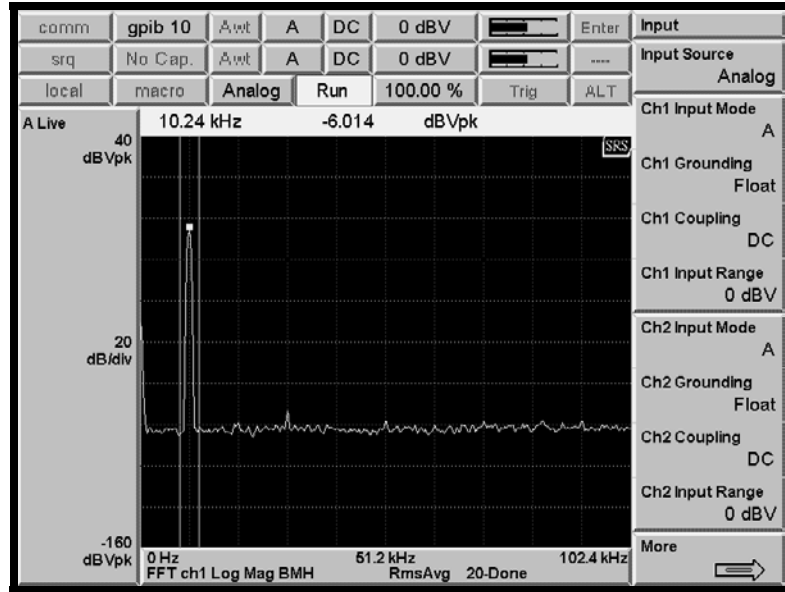

Figure Chapter 3 -4 Single Display Screen

The Single display format is shown above. The measurement of the inactive display continues even when it is not shown.

Data Graph

Data is normally graphed with signal amplitude on the Y axis and frequency or time on the X axis. The physical size of the graph remains constant while the vertical and horizontal scales may be changed. The graph area has a dotted grid for reference. There are 10 horizontal divisions and either 8, 10, 12 or 15 vertical divisions. The horizontal span is determined by the measurement span or time. The display normally shows the entire measurement span. The X axis may be expanded (Zoom) and translated (Pan) to display less than the full measurement span. This expansion does not change the measurement span or time, it merely changes the display of the data.

Half Intensity Data Graph

Unsettled measurement data is graphed in half intensity. Once the measurement becomes settled, the graph returns to full intensity.

FFT and Octave measurements are unsettled when the frequency span or resolution is changed and when the input signal path is changed (gain, filters, etc.). The measurement is not settled again until the discontinuity in the input data has propagated through the digital filters and, for FFT's, a complete new time record has been acquired.

FFT measurements running with a Time Record Increment less than 100% (overlapped time records) display unsettled measurements in half intensity.

Octave measurements show unsettled octave bins in half intensity. Each octave bin is displayed in half intensity until it is settled. The settling time of each bin is related to the 1/center frequency and the lowest bins take the longest time to settle.

Vertical Scale Bar

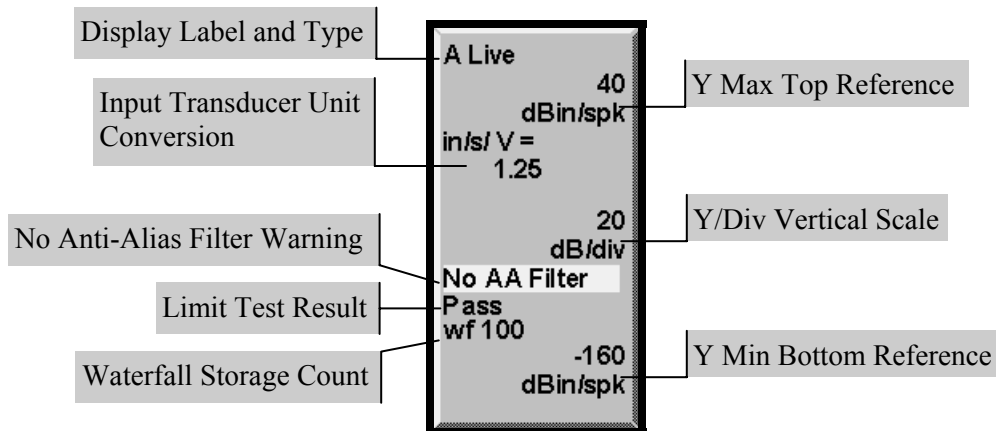

Chapter 3 -5 Vertical Scale Bar

The Vertical Scale Bar is at the left of the data graph for each display.

The display name, either 'A' or 'B' is at the top left corner. The display type (Live, Off-Line or Preview) is next to the display name. 'Live' indicates that the display is showing live measurement results from either the inputs or from capture. An 'Off-Line' display is showing a 'frozen' measurement. A display is Off-Line whenever data is recalled to the display from a Trace or from disk. 'Preview' only occurs when Average Preview is On and indicates that the display is showing a preview time record and is waiting for accept or reject.

The Y Max and Y Min reference values are shown along the right edge. Y Max is the top reference and Y Min is the bottom. The vertical scale per division is shown between Y Max and Y Min. The units and scale/division are selected in the [Display Setup] menu.

The Input Transducer Unit Conversion shows the Engineering Unit Conversions for the measurement input (either Ch1 or Ch2). If the display is showing a 2 channel measurement (such as transfer function), the conversion for both inputs are shown (Ch1 above Ch2).

The No Anti-Aliasing Filter warning is shown if any measurement input has its anti-aliasing filter off. Measurements made without the anti-aliasing filter may contain alias signals with frequencies above 102.4 kHz.

The Limit Test Result, either 'Pass' or 'Fail' is displayed if limit testing is on for this display.

The Waterfall Storage Count shows how many measurement records are currently stored in the waterfall buffer. This count is not displayed when Waterfall Storage is Off.

Horizontal Scale Bar

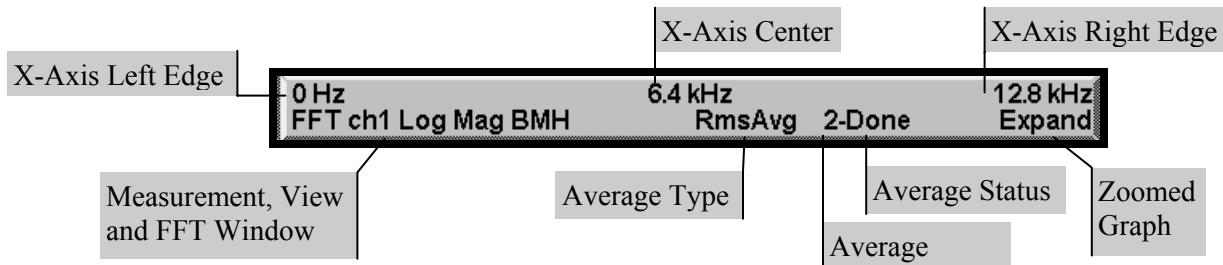

Figure Chapter 3 -6 Horizontal Scale Bar

The Horizontal Scale Bar is directly below the data graph.

When displaying spectral measurements with no horizontal expansion, these values are the Start, Center and Stop frequencies of the measurement. When displaying time records, these values are the Start and End of the time record.

Below the X-Axis labels, the measurement, view, window and averaging are shown. These parameters may be different for each display.

The Average Count shows the number of measurements averaged so far (up to the programmed Number of Averages). The Average Status shows 'Done' when a linear average is complete. 'Settle' is shown when the displayed measurement is not settled and is not added to the average. 'Reject' is shown when the Overload Reject is On and a measurement is not included in the average due to input overload.

For Swept Sine measurements, the estimated Sweep Time is displayed instead of the Average Count. This is the time to complete a sweep when no auto functions are selected (no Source Auto Level, no Auto Range, no Auto Resolution). This Sweep Time is simply the sum of the Settle and Integrate times for all points in the sweep.

To horizontally expand a graph, use <Pan> and <Zoom> in the [Display Setup] menu. When the display is expanded on the horizontal axis, the graph labels reflect the displayed data, not the actual measurement span or time. Expanded displays show the 'Expand' indicator.

Marker

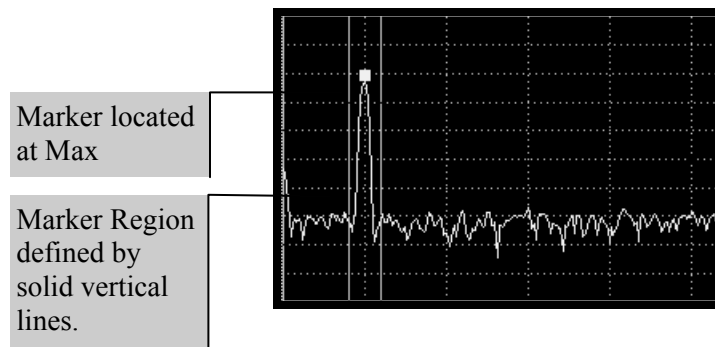

Figure Chapter 3 -7 Marker Region

The Marker Region is the graph region between the two solid vertical marker lines. The Marker Region Width may be set to 1 division (Wide), 1/2 division (Normal), or a single vertical line (Spot). The Marker Region is associated with the display and does not change with graph scaling. The Marker is the small square within the Marker Region. The Marker finds the Minimum, Maximum, or Mean of the data in the Marker Region. When seeking Min or Max, the Marker is located at the position of the minimum or maximum. This allows peaks and valleys in the data to be found easily. When seeking the Mean, the X position of the Marker is at the center of the Marker Region and the Y position is the mean of the data within the region. When a Spot Marker Region is used, the Marker is confined to a single X location. Use the [Marker] menu to configure the Marker for each display.

The Marker position is shown in the Marker Position Bar above the graph.

Use the knob to move the marker in the active display. The knob always moves the marker unless a menu softkey has been pressed and an entry field is displayed at the top of the screen.

Marker Position Bar

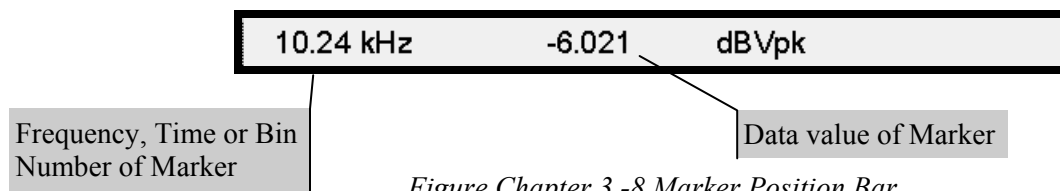

Figure Chapter 3 -8 Marker Position Bar

The Marker Position Bar is displayed above each graph.

The first value is the marker frequency, time or bin number. If the display is a waterfall, the waterfall record number is also shown.

The second value is the marker Y Position or data value. For 2-D displays (Nyquist or Nichols View), X and Y values are both displayed.

If a value is preceded by a Δ (delta) symbol, then the value is relative to a reference point or graph. Use the [Marker] menu to configure a relative reading.

If 'N/A' appears instead of a value, measurement data is not available. This often occurs when a measurement with a long acquisition time is changed and new data is not yet available.

If a '?' appears after a value, the displayed value has not actually been measured but is interpolated from actual measured points. This arises in Swept Sine sweeps with Auto Resolution On when some frequency points are not measured.

Active Display

The active display is indicated by the highlighted Marker Position bar. Use [Active Display] to toggle the active display.

Reference Graphs

In addition to the data graph, each display can also show a reference graph. The reference graph is a graph of a stored Reference Display and is drawn in half intensity. This allows comparison of live measurement data with a stored Reference Display.

The Reference Display data is copied from the current display data using [Display Ref] or loaded from a data Trace with [Trace to Ref].

Set the Marker Relative to Reference Display (in the [Marker] menu) to read the Marker Position relative to the Reference Display. Press [Display Ref] again to turn off the Reference Display.

Changing the Frequency Span or the Measurement turns the Reference Display off.

Changing the display scale does NOT rescale the Reference Display. This allows the live measurement display to be offset from the Reference Display by changing either Ymax, Ymid or Ymin in the [Display Setup] menu. To graph the Reference Display in the new display scale, press [Alt] [Snap Ref].

Menu Display

The softkey menu boxes define the functions of the softkeys to the right of the screen. Related functions and parameters are grouped into menus. Pressing each of the Menu keys displays a different set of menu boxes. There are three types of softkeys - buttons, lists and numeric values. A button performs a function, such as <Full Span>. A list presents a list of choices or options in the entry field (at the top of the screen). Use the knob to make a selection and press [Enter]. <Measurement> is an example of a list. A numeric value presents the current value in the entry field and awaits numeric entry. Enter a new value with the entry keys and press [Enter]. <Start Freq> is an example of a numeric value.

Menus which show parameters specific to a single display show the parameters for the active display. Use [Active Display] to change the active display.

A softkey menu box which is shown in gray is not available in the current measurement. Also, the measurement softkeys for an 'Off-Line' display are shown in gray indicating that they may not be changed.

Each menu is described at length in Chapter 4.

Status Indicators

In addition to the data displays and menu boxes, there are a number of status indicators which are displayed at the top of the screen.

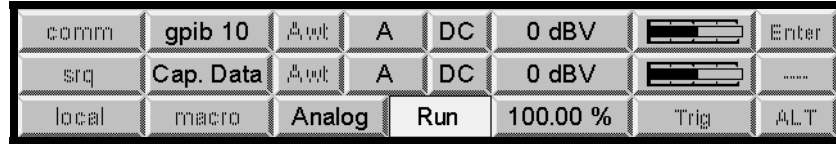

Figure Chapter 3 -9 Status Indicator Panel

Input Ranges

The Input Ranges for both inputs are displayed. If the range is set manually, the range indicator is on a normal background. If Auto Range is On, then the range is displayed on a highlighted background.

OverLoads

The input overload condition of the inputs are displayed to the right of their Input Ranges. The overload indicator is a bar. When the bar is 1 division long (displayed faintly), then the input signal is below half full scale. When the bar is 2 divisions long (displayed in black), the input signal is above half full scale (but not overloaded). When the bar is 4 divisions long (displayed brightly), the input signal exceeds full scale and is overloaded. This also sounds the audible overload alarm.

Once an overload occurs, the outline of the overload bar remains in the indicator. The overload outline indicates that the input has overloaded since the measurement was started. This is important when the measurement is linearly averaged and an overload occurs during the average. Pressing [Start/Reset] restarts the measurement and erases this overload outline.

Whenever an input greater than 57 V is detected at the input, the overload indicator displays 'HighV' on a bright background. The analyzer immediately switches to 34 dBV range to protect the input circuitry. Any attempt to change the input will not be allowed until the input signal is reduced to a safe level.

Input Configurations

The Input Mode and Coupling for both inputs are displayed. If the coupling is DC or AC, the coupling indicator is on a normal background. If ICP coupling is selected, then ICP is displayed on a highlighted background.

AWt

The A-Weighting filter status for both inputs are displayed. If the A-Weighting filter is ON, then 'AWt' is displayed on a highlighted background.

ArmWait/Trig-wait/Trig/Acquire

This indicator reads 'Trig-wait' while waiting for a trigger. Once triggered, the indicator flashes 'Trig' and then displays 'Acquire' while the time record is being acquired. If the Trigger Mode is Auto Arm, the indicator returns to 'Trig-wait' after the time record is

acquired. If the Trigger Mode is Manual Arm, then the indicator reads 'Arm-wait' while waiting for a manual arm command (or keypress).

Run/Pause/Done

'Run' indicates that the measurements of BOTH displays are running. Whenever new data is available for a Live display, the display will update. Off-Line displays do not update.

'Pause' indicates that the measurements of BOTH displays are paused.

'Done' indicates that single shot capture playback is finished.

Use the [Start/Reset] and [Pause/Cont] keys to control the measurements.

Analog/Playback

'Analog' indicates that the measurements of BOTH displays are taking their inputs from the Channel 1 Input or Channel 2 Input.

'Playback' indicates that the measurements of BOTH displays are taking their inputs from the Capture buffers.

Real Time

When the Measurement Group is FFT or Octave, the Real Time indicator shows the actual time record increment for the measurements in progress.

If the displayed increment is 100%, the start of the next time record is exactly one time record advanced from the start of the previous time record. If the increment is 25%, then the next time record starts 1/4 of a time record advanced from the start of the previous time record. This is sometimes referred to as 75% overlap since the two time records share 75% of a record. The overlap is simply 100% minus the Time Record Increment.

If the displayed increment is 200%, the start of the next time record is advanced from the start of the previous time record by 2 time records leaving a gap of 1 record. This means that the data between the two time records is not measured.

When the displayed increment is less than or equal to 100%, the measurement is said to be 'real time'. All time points contribute to one (or more) measurements.

When the displayed increment is greater than 100%, then the measurement is not 'real time' and some time points do not contribute to a measurement.

If the indicator shows a value greater than the requested Time Record Increment, it means that the measurement cannot be made with the requested increment but is running with the smallest increment possible. Factors which affect the processor's ability to run real time include the measurement type, averaging and source type.

See also Real Time Bandwidth and Overlap.

This indicator is replaced by the Capture/Playback Progress indicator when capture (playback) is in progress.

This indicator is replaced by the Sweep Frequency indicator when the Measurement Group is Swept Sine.

Sweep Frequency

The Sweep Frequency indicator shows the current frequency during Swept Sine sweeps. 'Ramping' is displayed if the source level is currently ramping. This indicator replaces the Realtime indicator when the Measurement Group is Swept Sine.

Capture Progress

During capture fill, the Capture Progress indicator shows how much of the capture buffer has been filled. During capture playback, this indicator shows the playback progress through the playback portion of the buffer. This indicator replaces the Realtime indicator when capture or playback is in progress.

No Cap./Cap. Data

The Capture indicator shows the status of the Capture buffer.

'No Cap.' indicates that the Capture buffer is empty. Input playback from Capture is not allowed. Arbitrary source playback from Capture is also not allowed.

'Capturing' indicates that capture is in progress. The capture progress is shown in the Real Time indicator position.

'Cap. Data' indicates that the Capture buffer contains data for playback.

Link

When an unlinked display parameter is being entered or modified, the Link indicator (next to the top of the menu) reads either 'DispA' or 'DispB', whichever is the active display. Parameter entry or selection modifies only the active display. To change which display will be modified, press [Active Display].

When a linked parameter is highlighted, the Link indicator reads 'Link'. Parameter entry or selection modifies both displays at once.

To link or unlink a parameter, highlight the parameter softkey and press the [Link] key. If the Link indicator is shown in gray, then the parameter linking may not be changed.

Parameter linking is a convenient way of changing both displays together. For example, Span and Start frequency may be linked while the Measurement is unlinked. This allows the two displays to have different measurements over the same frequency span. Since the Spans are linked, changing the Span does not require separate entries for each display.

Enter

When modifying a parameter, the [Enter] key enters the new parameter value or selection. When selecting from a list of choices with the knob, [Enter] will enter the new selection. When entering a numeric value, [Enter] will enter the new value. Whenever the 'Enter' indicator at the top of the screen is on, [Enter] is required to enter the new choice or entry.

ALT

Indicates that the ALTERNATE keypad is in use. The ALTERNATE keypad uses the alphabetic legends printed below each key. To enter the ALT mode, press the [ALT] key once. Pressing the keys will now enter alphabetic characters into the active entry field. The [0]...[9], [.] , [-], [\leftarrow] and [ALT] have the same function in the ALTERNATE keypad.

In ALTERNATE mode, the knob moves the waterfall marker along the Z axis.

To return to the normal keypad, press the [ALT] key again.

GPIB/RS232

This indicator shows 'RS232' if the interface responses are directed to the RS232 serial port.

This indicator shows 'GPIB' and the GPIB address if the interface responses are directed to the GPIB port.

Use <Output To> in the [System]<Remote> menu to select the appropriate interface.

Comm /Error

'Comm' is displayed when the computer interface is idle. 'RS232' flashes when there is activity on the RS232 interface. 'GPIB' flashes when there is activity on the GPIB interface.

'ERR' flashes whenever a computer interface error occurs, such as illegal command or out of range parameter is received.

SRQ

This indicator is on whenever a GPIB Service Request is generated by the SR780. SRQ stays on until a serial poll is completed.

Local/Remote/LOCK

'local' indicates that the unit is under local control (front panel enabled).

'REM' indicates that the unit is under remote interface control. The front panel may be locked out by a computer interface. To return the unit to local control, press the [Help/Local] key. <Override Remote> in the [System]<Remote> menu allows front panel control even in the REMOTE state.

'LOCK' indicates that the front panel is locked out and no front panel keypress will return the unit to the local state. No front panel adjustments may be made. An interface command (LOCL) is required to exit the LOCK state.

macro

‘Record’ indicates that a keypad macro is being recorded. Use [Macro Rec] to start recording.

‘Play’ indicates that a macro is being played. Use [Play Macro] to playback a stored macro.

See ‘Macros’ later in this chapter for more.

Keypad

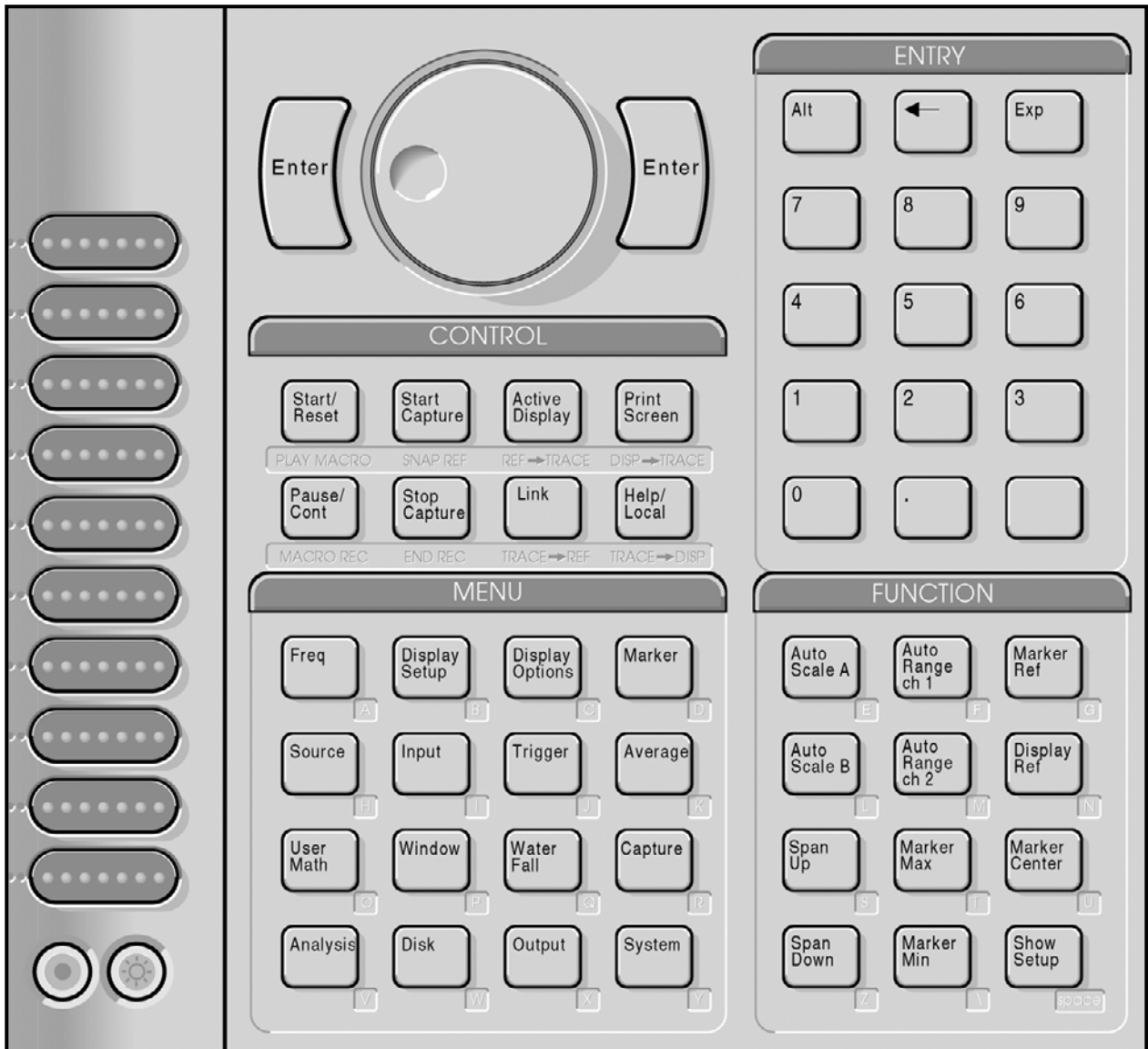

Figure Chapter 3 -10 Front Panel Keypad

Normal And Alternate Keys

The normal key definitions are printed on each key. In addition, many keys also have alternate definitions printed below them. Press the [Alt] key once to enter the ALT keypad mode. The ALT screen indicator is on indicating that the alternate key definitions are in use. Use the alternate keys to enter alphabetic characters and to access secondary functions. The [0]...[9], [.] , [-], [←], [Exp] and [Alt] keys have the same definition in both modes. Press [Alt] again to return to the normal keypad if necessary.

Menu Keys

All operating parameters of the SR780 are grouped into sixteen function menus. The menu keys select a menu of parameters to display next to the ten softkeys. The softkeys either choose a submenu or select a parameter and place it in the entry field at the top of the screen (for numeric entry or knob adjustment). The menus are listed below.

[Freq]	Set the frequency span parameters for measurements.
[Display Setup]	Select the measurement type, view, units and scale.
[Display Options]	Select the display format, grid, user units and log X axis.
[Marker]	Configure the markers.
[Source]	Turns on and configure source.
[Input]	Configures the signal inputs and select the input ranges.
[Trigger]	Setup the trigger.
[Average]	Turn averaging on and select the averaging type.
[User Math]	Define user math functions.
[Window]	Select the FFT measurement window.
[Waterfall]	Setup waterfall displays and storage.
[Capture]	Setup the time domain capture buffer.
[Analysis]	Setup data tables and limit testing.
[Disk]	Store and recall data and settings to and from disk.
[Output]	Configure the hardcopy output.
[System]	Configures the computer interfaces, preferences and clock. Diagnostics menu checks the instrument hardware.

Detailed descriptions of each menu are provided in the next chapter.

Entry Keys

To modify or examine a parameter, press the menu key which displays the appropriate softkeys. Press a softkey to select (highlight) a parameter or function. There are three types of softkeys or menu boxes - buttons, lists and numeric values.

The active display determines which display's parameters are shown in the menus. Press [Active Display] to toggle between DisplayA and DisplayB parameters. Only those parameters which are associated with an individual display have differing values between the displays.

When a display specific parameter is selected, the Link indicator next to the top of the menu is turned on. If the indicator reads 'DispA' or 'DispB', parameter entry or selection modifies only DisplayA or DisplayB. If the indicator reads 'Link', both displays are modified at once. To change the Link indicator, use the [Link] key.

Buttons

Buttons are the simplest type of softkey. Pressing a button performs the specified action. Examples of buttons are <Full Span>, <Preferences> and <Display to Disk>. Buttons simply show a graphic 'button' or 'arrow' in their menu box.

Lists

Parameters with a list of possible selections display their current selection in their softkey menu box. Examples of parameter lists are <View>, <Window> and <Averaging>.

To make a new selection, press the softkey to highlight its menu box. The list of possible choices is displayed in the entry field at the top of the screen. For example, to change the View, press [Display Setup] for the menu and then <View> (3rd softkey). The <View> menu box will be highlighted and the View selections will be listed at the top of the screen.

Use the knob to make the desired selection. If a vertical thermometer appears at the right of the entry field, then the selection list is too long to display at one time. The bright bar within the thermometer indicates the position within the complete list. Use the knob to scroll through the entire list. Choices shown in gray are not available in the current configuration. When the correct choice is selected, press [Enter] to change the parameter. The menu box now shows the new selection and becomes un-highlighted.

Many parameters require the [Enter] key to enter the new selection. In these cases, the Enter indicator next to the top of the menu will turn on while the selection is being made. No change is made until [Enter] is pressed. To cancel the operation, press the same softkey again (or another softkey to modify another parameter) instead of [Enter].

Some parameters do not require the [Enter] key to make the new selection valid. <Window> is an example. In this case, moving through the list of windows with the knob changes the Window immediately and displays the selection in the highlighted menu box. This allows the effect of various choices to be compared while making the selection. Press [Enter], the same softkey, another softkey or a menu key to un-highlight the menu box when finished.

List selection may also be made using the numeric keys. The choices are numbered 0 through 9. Press a number key to make a selection. If [Enter] is not required, the new selection immediately appears in the menu box. If [Enter] is required, the new selection appears when [Enter] is pressed.

If no menu box is highlighted, pressing a numeric entry key automatically selects the most recently modified parameter within the menu and begins numeric entry. This is convenient when a measurement requires a single parameter within a menu (or menus) to be modified repeatedly.

Numeric Values

Parameters with numeric values display their current value in their menu box. Examples of numeric parameters are , <# Avgs> and <Ch1 Input Range>. Some numeric values are 'continuous', such as <# Avgs>, while others can only have discrete values, such as .

To enter a new value, press the softkey to highlight its menu box. The parameter value is displayed in the entry field at the top of the screen. For example, to change the Span, press [Freq] for the menu and then (1st softkey). The menu box will be highlighted and the current Span value will be shown at the top of the screen.

The numeric entry keys are used to enter values directly. For example, to set the Span to 12.8 kHz, press [1] [2] [.] [8]. As soon as the [1] is pressed, the entry field shows the new value as it is entered. The list of appropriate units is displayed as well.

The entry field displays the characters as the keys are pressed. The '_' is the entry point. If an error is made, the backspace [←] key will erase the last character. Pressing the same softkey again (or another softkey to modify another parameter) will abort the entry operation and leave the value unchanged. Use the knob to select the (kHz) units. When the entry value is correct and the correct units are selected, press [Enter] to change the span to the new value.

Entries may be made in exponential form using the [Exp] key. The entry above may be made by pressing [1] [2] [.] [8] [Exp] [3] and selecting the (Hz) units.

Numeric entry always requires [Enter] to enter the new value.

If no menu box is highlighted, pressing a numeric entry key automatically selects the most recently modified parameter within the menu and begins numeric entry. This is convenient when a measurement requires a single parameter within a menu (or menus) to be modified repeatedly.

In general, numeric parameters may also be adjusted with the knob. In this case, knob adjustment must be made before any numeric entry is started. [Enter] is not required to enter the new value. Changes are effective immediately while the value is being adjusted. Press [Enter], the same softkey, another softkey or a menu key to un-highlight the menu box when finished. Some entry fields allow only knob adjustment or only numeric entry.

Control Keys

[Start/Reset]

If the unit is already making measurements, [Start/Reset] resets any averages and starts the measurement over. If the measurement is paused, [Start/Reset] starts the measurement over again. The Run/Pause indicator shows 'Run' when measurements are in progress.

If the measurement is triggered, [Start/Reset] does not supply a trigger. If the trigger is manual armed, [Start/Reset] does not arm the trigger.

If the displays don't update, see the Operating Hints in Chapter 2 for help.

Command: STRT

[Pause/Cont]

If the unit is already making measurements, [Pause/Cont] halts data acquisition. The measurement is paused where it is and the displays are not updated. The Run/Pause indicator shows 'Pause' when measurements are paused.

If the measurement is paused, [Pause/Cont] resumes the measurement where it was left off. To start over, press [Start/Reset]. The Run/Pause indicator shows 'Run' when measurements are in progress.

For Exponential FFT averaging, [Pause/Cont] simply resumes data acquisition without resetting the average. For Linear FFT averaging, [Pause/Cont] will complete the current average. If the linear average was already complete, [Pause/Cont] has no effect.

For Swept Sine measurements, [Pause/Cont] simply resumes the sweep where it was paused.

For Octave Analysis measurements, [Pause/Cont] resets the averages before starting again (same as [Start/Reset]).

Command: PAUS and CONT

[Start Capture]

[Start Capture] starts storing data in the capture buffer.

If the Trigger Mode is Free Run, capture starts immediately. Otherwise, the selected Trigger Mode and Source will be in effect and the next trigger event will start capture.

While capture is in progress, the displays do not update. The Capture Progress indicator shows how much of the desired capture length has been completed. If the Capture Mode is 1-Shot, capture stops when the buffer is full. Press [Stop Capture] to halt capture before the buffer is full.

If the Capture Mode is Continuous, once capture is started, it continues indefinitely and fills the capture buffer in a circular fashion. In this case, press [Stop Capture] to halt capture with the most recently acquired data stored in the buffer.

Use the [Capture] <Memory Allocation> menu to allocate memory between the capture buffer, waterfall storage and the arbitrary source waveform. Capture memory must be allocated before the capture buffer may be used.

To playback from the capture buffer, change the Input Source to Playback.

Command: CSTR

[Stop Capture]

[Stop Capture] stops storing data in the capture buffer.

If the Capture Mode is 1-Shot, capture stops when the buffer is full. Press [Stop Capture] to halt capture before the buffer is full.

If the Capture Mode is Continuous, once capture is started, it continues indefinitely and fills the capture buffer in a circular fashion. In this case, press [Stop Capture] to halt capture with the most recently acquired data stored in the buffer.

Turn off Auto Offset during capture to avoid interrupting the input signal.

To playback from the capture buffer, change the Input Source to Playback.

Command: CSTP

[Active Display]

Pressing [Active Display] toggles the active display. In single display format, the display switches between DisplayA and DisplayB. The display label, A or B, is at the upper left of each display. In dual display format, [Active Display] switches which display is active as indicated by the highlighted Marker Position bar above the graph.

The active display determines which display's parameters are displayed in the menus. For example, activating DisplayA and pressing [Display Setup] allows you to select the measurement for DisplayA. Pressing [Active Display] once makes DisplayB active and allows you to select the measurement for DisplayB using the same menu. Only those parameters which are associated with an individual display have differing values between the displays. Parameters such as input configuration or source setup are instrument parameters and are not associated with a display.

When a display specific parameter is highlighted (for modification), the Link indicator next to the top of the menu is turned on. If the indicator reads 'DispA' or 'DispB', parameter entry or selection modifies only DisplayA or DisplayB. If the indicator reads 'Link', both displays are modified at once. To change the Link indicator, use the [Link] key.

Parameter linking is a convenient way of changing both displays together. For example, Span and Start frequency may be linked while the Measurement is unlinked. This allows the two displays to have different measurements over the same frequency span. Since the Spans are linked, changing the Span does not require separate entries for each display.

Command: ACTD (?) i

[Link]

The [Link] key is used to link and unlink display specific parameters, to perform a function on both displays at once, or to temporarily link the display markers.

When an unlinked display specific parameter is highlighted (for modification), the Link indicator (next to the top of the menu) reads either 'DispA' or 'DispB', whichever is the active display. Parameter entry or selection modifies only the active display. To change which display will be modified, press [Active Display].

When a linked parameter is highlighted, the Link indicator reads 'Link'. Parameter entry or selection modifies both displays at once.

To link or unlink a parameter, highlight the parameter and press the [Link] key. If the Link indicator is shown in gray, then the parameter linking may not be changed.

Parameter linking is a convenient way of changing both displays together. For example, Span and Start frequency may be linked while the Measurement is unlinked. This allows the two displays to have different measurements over the same frequency span. Since the Spans are linked, changing the Span does not require separate entries for each display.

When a function key, such as [Marker Max], is pressed, the function is performed on the active display. If [Link] is pressed immediately before, then the function is performed on both displays at once. [Link] only affects the next key pressed. If the next key is not a function key then it has no affect. Linking affects each function differently. See the function key definitions for more information.

When no parameter softkey is highlighted, turning the knob adjusts the marker position in the active display. If [Link] is pressed, then the marker of the inactive display is linked to the active display and the knob moves both markers together. Pressing a key will cancel this link. If the key is a function key, its function will be linked.

[Print Screen]

The [Print Screen] hardkey allows you to print or plot the screen from any menu.

Configure printing and plotting in the [Output] menu and choose Print, Plot or Dump Screen as the Hard Copy Button function to configure the [Print Screen] hardkey.

Pressing [<-] (backspace) will abort the printout. No other front panel operations may be performed until printing is completed.

Command: PRNT, PLOT or DUMP

[Help/Local]

[Help/Local] provides on screen help for any key or softkey. Press [Help/Local] to enter the on-line help system. Press [Help/Local] again for more information on the help system.

When a host computer places the unit in the REMOTE state, no keypad or knob input is allowed. To return to front panel operation, press the [Help/Local] key.

[Alt] [Control Key]

Pressing [Alt] and a Control Key performs the function written below each key. These functions are described below.

Play Macro ([Alt] [Start/Reset])

[Play Macro] plays a recorded keypad macro. Use the knob to select a defined macro and press [Enter]. The Macro indicator at the top of the screen reads 'Play' while the macro is playing.

Macro Rec ([Alt] [Pause/Cont])

[Macro Rec] starts recording a macro. Use the knob to select which macro (0..9) will be recorded and press [Enter]. The Macro indicator at the top of the screen reads 'Record'. Press the desired sequence of keys. The instrument responds to these keys while the macro is being recorded. Press [End Rec] ([Alt] [Stop Capture]) to stop recording the macro.

Use the numeric keys to choose a parameter from a list (instead of the knob) while recording a macro. The list choices are numbered 0 through 9.

Use [Alt] and the numeric keys to choose the units of a numeric parameter while recording a macro. The units choices are numbered starting with 0 as the first (leftmost) units.

To play a recorded macro, press [Play Macro] ([Alt] [Start/Reset]) and choose the desired macro with the knob.

To edit a recorded macro, use [System] <Edit Macro>.

End Rec ([Alt] [Stop Capture])

[End Rec] stops recording a macro.

To play a recorded macro, press [Play Macro] ([Alt] [Start/Reset]) and choose the desired macro with the knob.

Snap Ref ([Alt] [Start Capture])

[Snap Ref] scales the Reference Display within the active display to the current display scale. Changing the display scale does NOT rescale the Reference Display. This allows the live measurement display to be offset from the Reference Display by changing either Ymax, Ymid or Ymin in the [Display Setup] menu.

Press [Display Ref] to copy the display data into the Reference Display. The Reference Display is graphed in the background.

Command: SNAP d

Ref to Trace ([Alt] [Active Display])

[Ref to Trace] saves the active display's Reference Display (if it is on) to a Trace buffer.

Select a Trace # (1..5) with the knob and press [Enter] to save the Reference Display to the Trace.

A stored trace can be recalled to a Display or Reference Display, used in a User Math Function, saved to disk, or copied to the Arbitrary Waveform buffer.

Command: SVRF d, i

Trace to Ref ([Alt] [Link])

[Trace to Ref] copies Trace data into the active display's Reference Display.

Select a Trace # (1..5) with the knob and press [Enter] to copy the Trace to the Reference Display. Only those Traces which currently have data can be selected. In addition, the Trace data must be compatible with active display measurement. For example, if the Trace is a time record, it cannot be copied into the Reference Display of an FFT measurement.

Command: RCRF d, i

Display to Trace ([Alt] [Print Screen])

[Display to Trace] saves the active display's measurement data to a Trace buffer.

Select a Trace # (1..5) with the knob and press [Enter] to save the display data to the Trace.

A stored trace can be recalled to a Display or Reference Display, used in a User Math Function, saved to disk, or copied to the Arbitrary Waveform buffer.

Command: SVTR d, i

Trace to Display ([Alt] [Help/Local])

[Trace to Display] recalls Trace data to the active display.

Select a Trace # (1..5) with the knob and press [Enter] to recall the Trace data to the active display.

The active display will be set to Off-Line when data is recalled to it. The display will not update with live measurement results until the Display is set back to Live (in the [Display Options] menu).

The measurement, frequency span, averaging and window are recalled with the data and cannot be changed. These menus are shown in gray and reflect the settings or values for the last Live measurement. Parameters which pertain to the display of the data, such as Scale and View, may be changed in the [Display Setup] and [Display Options] menus.

When the Display is returned to Live, the measurement, frequency span, averaging and window all return to the settings in effect before the data was recalled and the live measurement returns to the display.

Command: RCTR d, i

Function Keys

[Auto Scale A]

[Auto Scale A] automatically sets the vertical scale of DisplayA to show the entire range of the data. Horizontal scaling is not affected.

Auto scale only operates on the data which is displayed on the graph. If the graph is expanded, data corresponding to frequency or time bins which are not shown do not figure in the auto scaling calculations.

[Link] [Auto Scale A] auto scales DisplayA and sets the vertical scale of DisplayB to match DisplayA.

Command: ASCL d

[Auto Scale B]

[Auto Scale B] automatically sets the vertical scale of DisplayB to show the entire range of the data. Horizontal scaling is not affected.

Auto scale only operates on the data which is displayed on the graph. If the graph is expanded, data corresponding to frequency or time bins which are not shown do not figure in the auto scaling calculations.

[Link] [Auto Scale B] auto scales DisplayB and sets the vertical scale of DisplayA to match DisplayB.

Command: ASCL d

[Auto Range Ch1]

[Auto Range Ch1] toggles Channel 1 Input Ranging between Manual and Auto. In Manual Ranging, the Input Range is set within the [Input] menu. In Auto Range, the Input Range is adjusted automatically according to the Ch1 AutoRange Mode (also in the [Input] menu). In Normal Auto Range, only overloads cause the range to change. In Tracking Auto Range, the Input Range moves up for overloads and down when the signal falls below half scale.

In Swept Sine group, Auto Range is always tracking.

The Ch1 Input Range indicator at the top of the screen will be shown in inverse if Ch1 is Auto Ranging.

Auto Range responds to all frequencies present at the input (except those attenuated by AC coupling), not just those within the measurement span.

[Link] [Auto Range Ch1] toggles the Input Ranging of both channels.

Command: AIRG (?) {i}

[Auto Range Ch2]

[Auto Range Ch2] toggles Channel 2 Input Ranging between Manual and Auto. In Manual Ranging, the Input Range is set within the [Input] menu. In Auto Ranging, the Input Range is adjusted automatically according to the Ch2 AutoRange Mode (also in the [Input] menu). In Normal Auto Range, only overloads cause the range to change. In Tracking Auto Range, the Input Range moves up for overloads and down when the signal falls below half scale.

In Swept Sine group, Auto Range is always tracking.

The Ch2 Input Range indicator at the top of the screen will be shown in inverse if Ch2 is Auto Ranging.

Auto Range responds to all frequencies present at the input (except those attenuated by AC coupling), not just those within the measurement span.

[Link] [Auto Range Ch2] toggles the Input Ranging of both channels.

Command: A2RG (?) {i}

[Span Up]

In FFT group, [Span Up] increases the FFT frequency Span of both displays by a factor of 2. This provides a way of adjusting the spans regardless of which menu is displayed. The Span is adjusted with either a fixed start, Center or End frequency depending upon which frequency was most recently anchored in the [Frequency] menu.

In Octave group, [Span Up] moves the octave measurement span of both displays up by an octave.

[Span Up] affects each display independently if their frequency parameters are unlinked.

[Span Up] has no affect for Swept Sine measurements.

[Link] [Span Up] is the same as [Span Up].

Command: FSPN (?) d {, i}

[Span Down]

In FFT group, [Span Down] decreases the FFT frequency Span of both displays by a factor of 2. This provides a way of adjusting the spans regardless of which menu is displayed. The Span is adjusted with either a fixed Start, Center or End frequency depending upon which frequency was most recently anchored in the [Frequency] menu.

In Octave group, [Span Down] moves the octave measurement span of both displays down by an octave.

[Span Down] affects each display independently if their frequency parameters are unlinked.

[Span Down] has no affect for Swept Sine measurements.

[Link] [Span Down] is the same as [Span Down].

Command: FSPN (?) d {, i}

[Marker Ref]

[Marker Ref] toggles the Marker Rel Mode (in the [Marker] menu) between Off and Relative for the active display. If Marker Rel is Off, [Marker Ref] sets Marker Rel to Relative and sets the X-Rel and Y-Rel Marker Offsets to the current Marker Position. Subsequent marker readings are relative to this offset. The relative Marker Position values are preceded by a Δ (delta) symbol. The Marker Offset location within the display is marked by small flag shaped symbols.

If Marker Rel is Relative, [Marker Ref] sets Marker Rel to Off and the Marker Position is absolute.

[Marker Ref] has no affect if the Marker Rel Mode is not Off or Relative.

[Link] [Marker Ref] toggles the Marker Rel Mode of both displays.

Command: MRON (?) d

[Display Ref]

[Display Ref] toggles the Reference Display within the active display. If the Reference Display is off, [Display Ref] loads the Reference Display with the current display data. The Reference Display is graphed in half intensity. This allows comparison of new data with the stored Reference Display. Set the Marker Relative to Reference Display (in the [Marker] menu) to read the Marker Position relative to the Reference Display. Press [Display Ref] again to turn off the Reference Display.

Changing the Frequency Span or the Measurement turns the Reference Display off.

Changing the display scale does NOT rescale the Reference Display. This allows the live measurement display to be offset from the Reference Display by changing either Ymax, Ymid or Ymin in the [Display Setup] menu. To graph the Reference Display in the new display scale, press [Alt] [Snap Ref].

[Link] [Display Ref] toggles the Reference Display of both displays.

Command: DREF d, i

[Marker Center]

[Marker Center] sets the FFT Center frequency to the Marker frequency in the active display. If the new Center frequency and Span conflict with the maximum measurement range, 0 to 102.4(100.0) kHz, then the Span is decreased to the largest span which allows the Marker frequency to be the center.

[Link] [Marker Center] adjusts the span of the active display and sets the Span of the inactive display to match.

Command: MKCN d

[Marker Max]

[Marker Max] moves the Marker to the location of the maximum data value within the active display. [Marker Max] only searches the data which is in the display. If the maximum value occurs at more than one location, then the one closest to the left edge is found.

If the Marker Mode (in the [Marker] menu) is Normal, [Marker Max] centers the marker region around the maximum. The Marker Seeks Mode chooses whether the Marker seeks the Maximum, Minimum or Mean of the data within the Marker Region.

For Harmonic or Sideband markers, [Marker Max] moves the Fundamental Marker to the location of the maximum. [Marker Max] has no affect on Band markers.

[Link] [Marker Max] moves the Marker to the location of the maximum within both displays.

Command: MKMX d

[Marker Min]

[Marker Min] moves the Marker to the location of the minimum data value within the active display. [Marker Min] only searches the data which is in the display. If the minimum value occurs at more than one location, then the one closest to the left edge is found.

If the Marker Mode (in the [Marker] menu) is Normal, [Marker Min] centers the Marker Region around the minimum. The Marker Seeks Mode chooses whether the marker seeks the Maximum, Minimum or Mean of the data within the Marker Region.

For Harmonic or Sideband markers, [Marker Max] moves the Fundamental Marker to the location of the minimum. [Marker Max] has no affect on Band markers.

[Link] [Marker Min] moves the marker to the location of the minimum within both displays.

Command: MKMN d

[Show Setup]

[Show Setup] enters the Help system and displays the measurement setup and system settings. Press [0] to exit Help and return to the measurement displays.

Macros

Keypad Macros

A sequence of front panel key presses can be recorded and played as a macro. There are 10 macros which may be defined. Macro definitions are retained at power down. Macros are saved to disk with the instrument settings.

Use [Macro Rec] ([Alt] [Pause/Cont]) to start recording a macro. Use the knob to select which macro (0..9) will be recorded and press [Enter]. Press the desired sequence of keys. The instrument responds to these keys while the macro is being recorded. Press [End Rec] ([Alt] [Stop Capture]) to stop recording the macro.

To play a recorded macro, press [Play Macro] ([Alt] [Start/Reset]), choose the desired macro with the knob and press [Enter].

To edit a recorded macro, use [System] <Edit Macro>.

Choosing From Lists

The knob is normally used to pick an entry from a list. However, knob movements are recorded as movement relative to the starting position. This leads to ambiguity when using the knob in a macro. Playing the macro will have different results depending upon the starting state of the instrument. Thus, using the knob within a macro to choose a parameter is not recommended.

To choose a parameter from a list, the numeric keys should be used instead of the knob while recording a macro. The list choices are numbered 0 through 9. Press a number key to make a selection and [Enter] if required. For example, to select the Hanning window, press [Window] <Window> [2] [Enter] since Hanning is entry number 2.

If the parameter list has more than 10 choices, FFT Measurement for example, then the knob must be used. In this case, use a numeric key entry to first pick a known selection and then use the knob to select an entry in the list relative to it. For example, to choose Capture1 as the FFT Measurement, press [Display Setup] <Measurement> [0] [Enter] <Measurement> {select Capture1 with the knob} [Enter]. The first entry selects FFT1 with the [0] key regardless of the current measurement. The knob then selects a position in the list relative to FFT1.

Menus

When recording a macro, remember that the macro is played back EXACTLY as recorded. Thus, do not start a macro with a softkey press since the menu which is displayed at playback may not be the one displayed when the macro was recorded. Always start a macro with a menu key press if you want to change parameters within a menu.

Chapter 4

Menus

The SR780 has a menu driven user interface. All operating parameters of the SR780 are grouped into sixteen menus. The Menu keys each display a menu of softkeys. The softkeys at the right of the display change depending upon the displayed menu.

There are three types of softkeys - buttons, lists and numeric values. A button performs a function, such as <Full Span>. A list presents a list of choices or options in the entry field (at the top of the screen). Use the knob to make a selection and press [Enter]. <Measurement> is an example of a list. A numeric value presents the current value in the entry field and awaits numeric entry. Enter a new value with the entry keys and press [Enter]. <Start Freq> is an example of a numeric value.

Some parameters can have different values or settings for each display. In these cases, the menu shows the values or settings for the active display. Press [Active Display] to toggle the active display and show the values or settings for the other display. <Measurement> is an example of such a parameter. Use [Link] to link a parameter to a single display or to both displays at once.



Help for any key or softkey is available on screen by pressing [Help/Local]. Simply press any key for help about that key or function. Press [0] to exit help.

In This Chapter

Frequency Menus	4-7	Swept Sine Frequency Menu	4-15
FFT Frequency Menu	4-7	Start	4-15
Span	4-7	Stop	4-15
Linewidth	4-8	Repeat	4-16
Acquisition Time	4-8	Type	4-16
Full Span	4-8	Auto Resolution	4-16
FFT Lines	4-8	Number of Points	4-17
Base Frequency	4-9	Maximum Step Size	4-17
Start Frequency	4-9	Faster Threshold	4-17
Center Frequency	4-10	Slower Threshold	4-18
End Frequency	4-10		
Octave Frequency Menu	4-12	Display Setup Menu	4-19
Highest Band	4-12	Measurement Group	4-19
Lowest Band	4-12	Measurement (FFT)	4-19
Octave Resolution	4-13	Measurement (Octave Analysis)	4-25
Octave Channels	4-13	Measurement (Swept Sine)	4-26
		View	4-27
		Units	4-29

4-2 Menus

Y Max	4-30	Source Menu	4-51
Y Mid	4-30	Source Off	4-51
Y Min	4-30	Source On	4-51
Y / Div	4-30	Sine	4-51
X Center (Polar)	4-31	Chirp	4-52
X / Div (Polar)	4-31	Noise	4-52
Y Center (Polar)	4-31	Arbitrary	4-53
Y / Div (Polar)	4-31	Sine Source Menu	4-55
Pan	4-32	Frequency 1	4-55
Zoom	4-32	Amplitude 1	4-55
Display Options Menu	4-33	Offset	4-56
Display	4-33	Tone 2	4-56
Format	4-33	Frequency 2	4-56
X-Axis	4-34	Amplitude 2	4-56
Grid	4-34	Chirp Source Menu	4-57
Grid Div	4-34	Amplitude	4-57
PSD Units	4-35	Burst	4-57
Transducer Convert	4-35	Source Display	4-58
dBm Reference Impedance	4-36	Noise Source Menu	4-59
Phase Suppress	4-36	Amplitude	4-59
d/dx Window	4-36	Type	4-59
Marker Menu	4-37	Burst	4-60
Marker	4-37	Source Display	4-60
Mode	4-37	Source Period	4-60
Normal Marker Menu	4-40	Arbitrary Source Menu	4-62
Seeks	4-40	Amplitude	4-62
Width	4-40	Source Play Rate	4-62
Rel	4-41	Source	4-63
X-Rel	4-41	More	4-63
Y-Rel	4-42	Arb. Source Start	4-64
X-Rel	4-42	Arb. Source Length	4-64
Harmonic Marker Menu	4-43	Set Left Edge	4-64
Harmonics	4-43	Set Right Edge	4-64
Display	4-43	Allocate Memory	4-65
Readout Mode	4-44	Trace to Arb	4-65
THD	4-44	Swept Sine Source Menu	4-67
Harmonic Power	4-44	Auto Level Reference	4-67
Sideband Marker Menu	4-45	Amplitude	4-67
Sideband Separation	4-45	Ideal Reference	4-68
# Sidebands	4-45	Source Ramping	4-68
Display	4-46	Source Ramp Rate	4-68
Readout Mode	4-46	Reference Upper Limit	4-69
Sideband Ratio	4-46	Reference Lower Limit	4-69
RMS Sideband Power	4-47	Maximum Source Level	4-69
Band Marker Menu	4-48	Input Menu	4-71
Modify Band	4-48	Input Source	4-71
Band Exclude	4-48	Analog Input Menu	4-71
Band Ratio Mode	4-49	Ch1 Input Mode	4-72
Band Power	4-49	Ch1 Grounding	4-72
Band Ratio	4-49	Ch1 Coupling	4-72
		Ch1 Input Range	4-72

Ch2 Input Mode	4-73	Linear Average Mode	4-101
Ch2 Grounding	4-73	Swept Sine Average Menu	4-103
Ch2 Coupling	4-73	Settle Time	4-103
Ch2 Input Range	4-74	Settle Cycles	4-103
More	4-75	Integration Time	4-104
Ch1 AA Filter	4-75	Integration Cycles	4-104
Ch1 A-Wt Filter	4-75	User Math Menu	4-107
Ch1 AutoRange	4-76	Function	4-107
Ch2 AA Filter	4-76	dB Conversion	4-107
Ch2 A-Wt Filter	4-76	Edit Function	4-107
Ch2 AutoRange	4-76	Operands	4-108
Auto Offset	4-77	Operations	4-110
Transducer Parameters	4-78	Function String	4-112
Engineering Units	4-78	Insert/Replace	4-112
EU Label	4-79	Delete	4-112
EU / Volt	4-79	Clear Eq.	4-112
EUs at Marker	4-79	Cancel	4-112
User Label	4-80	Enter Eq.	4-113
Playback Input Menu	4-81	Edit Constant	4-113
Playback Start	4-81	Constant	4-113
Playback Length	4-81	Real Part	4-113
Set Left Edge	4-81	Imaginary Part	4-113
Set Right Edge	4-82	Mag	4-114
Playback Mode	4-82	Phase(deg)	4-114
Playback Speed	4-82	Marker to Mag	4-114
Trigger Menu	4-85	Window Menu	4-115
Trigger Mode	4-85	Window	4-115
Trigger Source	4-86	Force Length	4-117
Trigger Level	4-86	Expo TC	4-117
Trigger Slope	4-87	Trace to Window	4-117
Delay A	4-87	Window to Trace	4-118
Delay B	4-87	Window Form	4-118
Trigd Source Mode	4-88	Waterfall Menu	4-119
Manual Arm	4-88	Display	4-119
Manual Trigger	4-89	Storage	4-120
Average Menus	4-91	Total Count	4-121
FFT Average Menu	4-91	Skip/Storage Interval	4-121
Averaging	4-91	View Count	4-122
Averaging Mode	4-92	Trace Height	4-122
Averaging Type	4-93	Angle	4-122
Number of Averages	4-95	Allocate Memory	4-123
Time Record Increment	4-95	Marker to Z	4-124
Overload Reject	4-96	More	4-124
Average Preview	4-97	Fast Angles	4-124
Preview Time	4-97	Threshold	4-125
Accept	4-97	Hidden Lines	4-125
Reject	4-98	Paused Drawing	4-125
Octave Average Menu	4-99	Record to Trace	4-126
Averaging Type	4-99	Slice to Trace	4-126
Integration Time	4-100	Capture Menu	4-127
Confidence	4-101	Capture Channels	4-127
Power Bin	4-101	Capture Mode	4-127

4-4 Menus

Capture Length	4-128	Disk Menu	4-145
Sampling Rate	4-128	File Name	4-145
Allocate Memory	4-128	Current Directory	4-146
Total Available	4-129	Display to Disk	4-146
Capture Memory	4-129	Disk to Display	4-146
Waterfall Memory	4-129	Settings to Disk	4-146
Arb Memory	4-129	Recall Settings	4-147
Confirm Allocation	4-129	Trace to Disk	4-147
Clear Allocation	4-129	Disk to Trace	4-147
View Header	4-129	Buffers	4-147
Auto Pan	4-129	Disk Upkeep	4-148
Analysis Menu	4-131	Nodal Degree-of-Freedom Menu	4-149
Data Table	4-131	Reference Name	4-149
Limit Test	4-131	Reference Number	4-149
Marker Stats	4-132	Reference Direction	4-150
Exceedance Stats	4-132	Response Name	4-150
Data Table Analysis Menu	4-133	Response Number	4-150
Data Table	4-133	Response Direction	4-150
Insert Line	4-133	Abort Save	4-151
Delete Line	4-133	Continue Save	4-151
Clear Table	4-134	Recall Settings Menu	4-152
Limit Testing Analysis Menu	4-135	File Name	4-152
Limit Segments	4-135	Current Directory	4-152
Limit Testing	4-135	Measurements	4-153
Limit Beep	4-135	Sources	4-153
Clear Limits	4-136	Analysis	4-153
Edit Limits	4-136	Inputs/Triggers	4-153
New Segment	4-136	DRAM settings	4-153
Limit Type	4-136	General System	4-154
Segment #	4-137	Macros	4-154
X0	4-137	Recall from Disk	4-154
Y0	4-137	Disk Buffers Menu	4-155
X1	4-137	File Name	4-155
Y1	4-137	Current Directory	4-155
Delete Segment	4-137	Load Trace Data (ASCII)	4-156
Shift All	4-138	Load Trace Data (binary)	4-157
Marker Statistics Menu	4-139	Buffer	4-158
Marker Stats.	4-139	Interval	4-158
Reset	4-139	Disk to Buffer	4-158
Max (Display A)	4-140	Buffer to Disk	4-159
Min (Display A)	4-140	Disk Upkeep Menu	4-161
Mean (Display A)	4-140	File Name	4-161
Std. Dev. (Display A)	4-140	Current Directory	4-161
Max (Display B)	4-140	Make Directory	4-162
Min (Display B)	4-141	Del File	4-162
Mean (Display B)	4-141	Del Cur Dir	4-162
Std. Dev. (Display B)	4-141	Format Floppy	4-162
Exceedance Statistics Menu	142	Output Menu	4-163
Start Index	142	Hard Copy Button	4-163
Stop Index	142	Bitmap/Printer	4-164
Exceedance Pct	143	Bitmap Area	4-164
Calculate Excd	143	Vector/Plotter	4-164

Destination	4-165	Keyboard Test	4-180
GPIB Control	4-165	Knob Test	4-180
GPIB Address	4-166	RS232/Printer Test	4-180
Edit A Note	4-166	String to RS232	4-181
Text X Position	4-166	String to Printer	4-181
Text Y Position	4-166	Memory Test	4-181
Display	4-166	System RAM	4-181
Visible	4-167	System ROM	4-181
Text String	4-167	Video RAM	4-181
File Start Number	4-167	Help ROM	4-181
Colors	4-167	Disk Test	4-181
Print Bright	4-168	Serial Number	4-182
Print Dim	4-168	Program S/N	4-182
Print Black	4-168	Kill AutoOff	4-182
Print Graph	4-168	Edit Macro Menu	4-183
Plotter Text Pen	4-168	Special Keys	4-183
Plotter Grid Pen	4-168	Macro String	4-183
Plotter Trace Pen	4-169	Insert/Replace	4-183
Plotter Marker Pen	4-169	Inc. Knob Count	4-184
System Menu	4-171	Dec. Knob Count	4-184
Preset	4-171	Delete	4-184
Remote	4-171	Clear Macro	4-184
Preferences	4-171	Cancel	4-184
Date/Time	4-172	Enter Macro	4-184
Diagnostics	4-172		
Macro	4-172		
Edit Macro	4-172		
Show Settings	4-172		
Show Version	4-173		
System Remote Menu	4-174		
Output To	4-174		
GPIB Address	4-174		
Override REM?	4-174		
Baud Rate	4-174		
Word Length	4-175		
Parity	4-175		
View Qs	4-175		
System Preferences Menu	4-176		
Key Click	4-176		
Alarms	4-176		
Alarms Volume	4-176		
Done Volume	4-176		
Audible Overload	4-177		
Screen Saver	4-177		
Screen Saver Delay	4-177		
Frequency Format	4-177		
Node Info Prompt	4-178		
System Date/Time Menu	4-179		
Time	4-179		
Date	4-179		
System Diagnostics Menu	4-180		
Keypad Test	4-180		

Frequency Menus

The Measurement Group (FFT, Octave Analysis or Swept Sine) determines which Frequency menu is displayed. This menu sets the frequency parameters for the measurement. A set of parameters is stored for each group.

FFT Frequency Menu

When the measurement group is FFT, this menu sets the frequency span and location for the active display.

Frequency	
Span	51.2 kHz
Line Width	128 Hz
Acquisition Time	7.81 ms
Full Span	<input type="checkbox"/>
FFT Lines	400
Base Freq.	102.4 kHz
Start Freq.	0 Hz
Center Freq.	25.6 kHz
End Freq.	51.2 kHz

Span

Select the FFT Span of the active display. The frequency Span ranges from the FFT Base Frequency (102.4 kHz or 100.0 kHz) to 2^{-19} times the Base Frequency (195.3 mHz or 191 mHz) in factors of 2. A numerically entered value is rounded to the nearest allowable Span. If the new frequency Span would extend below 0 Hz or above the Base Frequency, then the Start and End frequencies will be adjusted.

Changing the Span will change the Linewidth (Span/FFT Resolution) and Acquisition Time (FFT Resolution/Span). The Linewidth and Acquisition time are other ways to change the Span.

The two displays can have different FFT Spans. This entry field can be linked to both displays using the [Link] key. If either display is a two channel measurement (Transfer Function, Cross Spectrum, Cross Correlation Or Coherence), then the Spans are automatically linked.

Command: FSPN (?) d {, i}

Linewidth

Select the Linewidth of the active display. The Linewidth is defined as the Span divided by the FFT Resolution (100, 200, 400 or 800 lines). A numerically entered value is rounded to the nearest allowable Linewidth.

Changing the Linewidth will change the Span (Linewidth x FFT Resolution) and Acquisition Time (1/Linewidth). The Linewidth and Acquisition Time are other ways to change the Span. If the new frequency Span would extend below 0 Hz or above the FFT Base Frequency, then the Start and End frequencies will be adjusted.

The two displays can have different FFT Linewidths. This entry field can be linked to both displays using the [Link] key. If either display is a two channel measurement (Transfer Function, Cross Spectrum, Cross Correlation Or Coherence), then the Linewidths are automatically linked.

Command: FSPN (?) d {, i}

Acquisition Time

Select the Acquisition Time of the active display. The Acquisition Time is the time record length for the FFT (FFT Resolution/Span). A numerically entered value is rounded to the nearest allowable Acquisition Time.

Changing the Acquisition Time will change the Span (FFT Resolution/Acquisition Time) and Linewidth (1/Acquisition Time). The Linewidth and Acquisition time are other ways to change the Span. If the new frequency Span would extend below 0 Hz or above the FFT Base Frequency, then the Start and End frequencies will be adjusted.

The two displays can have different FFT Acquisition Times. This entry field can be linked to both displays using the [Link] key. If either display is a two channel measurement (Transfer Function, Cross Spectrum, Cross Correlation Or Coherence), then the Acquisition Times are automatically linked.

Command: FSPN (?) d {, i}

Full Span

Set the FFT Span of both displays to the FFT Base Frequency 102.4 (100.0) kHz. The Linewidth, Acquisition Time, Start frequency and Center frequency are set to 256 (250) Hz, 3.906 (4.00) ms, 0.0 Hz, and 51.2 (50.0) kHz respectively.

FFT Lines

Select the FFT Resolution of the active display [100, 200, 400, 800 lines].

Changing the FFT Resolution does not change the Span. Instead, the Acquisition Time is changed (FFT Resolution/Span).

Fewer lines means wider linewidths (poorer resolution) but faster measurements. More lines means narrower linewidths (better resolution) but slower measurements.

The various FFT resolutions are summarized below.

FFT Resolution	Frequency Resolution	Time Record
100 lines	Span/100	100/Span
200 lines	Span/200	200/Span
400 lines	Span/400	400/Span
800 lines	Span/800	800/Span

The two displays can have different FFT Resolutions. This entry field can be linked to both displays using the [Link] key. If either display is a two channel measurement (Transfer Function, Cross Spectrum Or Cross Correlation), then the FFT Resolutions are automatically linked.

Command: FLIN (?) d {, i}

Base Frequency

Select the FFT Base Frequency [102.4 kHz, 100.0 kHz].

The Base Frequency sets the Full Span bandwidth for FFT measurements. All spans are derived from the base frequency by dividing by powers of 2. 102.4 kHz is commonly used and has an advantage at narrow spans where even bin frequencies of 1 Hz, 0.5 Hz, etc. are available. 100.0 kHz has even bin frequencies of 1000 Hz, 500 Hz, etc. at wide spans.

Changing the FFT Base Frequency affects ALL of the FFT frequency parameters as well as the source frequency.

All FFT measurements on BOTH displays use the same Base Frequency.

Command: FBAS (?) d {, i}

Start Frequency

Set the Start frequency of the active display FFT span. The Start frequency is the lowest frequency in the measurement span. The knob adjusts the Start frequency in steps equal to the Linewidth. If an entered Start frequency is incompatible with the Span, then it will be set to the closest allowed value.

This softkey also anchors the Start frequency. Adjusting the FFT Span will leave the Start frequency unchanged. Enlarging the frequency Span may change the Start frequency if the new measurement would extend below 0 Hz or above 102.4 (100.0) kHz.

If the Measurement is a Correlation, then the Start frequency is always 0 Hz (baseband).

4-10 FFT Frequency Menu

The two displays can have different FFT Start frequencies. This entry field can be linked to both displays using the [Link] key. If either display is a two channel measurement (Transfer Function, Cross Spectrum Or Coherence), then the Start frequencies are automatically linked. If either measurement is Cross-Correlation, then the Start frequency of both displays is set to 0 Hz.

Command: FSTR (?) d {, f}

Center Frequency

Set the Center frequency of the active display FFT span. The Center frequency is the center of the measurement span. The knob adjusts the Center frequency in steps equal to the Linewidth. If an entered Center frequency is incompatible with the Span, then it will be set to the closest allowed value.

This softkey also anchors the Center frequency. Adjusting the FFT Span will leave the Center frequency unchanged. Enlarging the frequency Span may change the Center frequency if the new measurement would extend below 0 Hz or above 102.4 (100.0) kHz.

If the measurement is a Correlation, then the Center frequency is always equal to Span/2 (baseband).

The two displays can have different FFT Center frequencies. This entry field can be linked to both displays using the [Link] key. If either display is a two channel measurement (Transfer Function, Cross Spectrum Or Cross Correlation), then the Center frequencies are automatically linked. If either measurement is Cross-Correlation, then the Center frequency of both displays is set to Span/2.

Command: FCTR (?) d {, f}

End Frequency

Set the End frequency of the active display FFT span. The End frequency is the highest frequency in the measurement span. The knob adjusts the End frequency in steps equal to the Linewidth. If an entered End frequency is incompatible with the Span, then it will be set to the closest allowed value.

This softkey also anchors the End frequency. Adjusting the FFT Span will leave the End frequency unchanged. Enlarging the frequency Span may change the End frequency if the new measurement would extend below 0 Hz or above 102.4 (100.0) kHz.

If the measurement is a Correlation, then the End frequency is always equal to the Span (baseband).

The two displays can have different FFT End frequencies. This entry field can be linked to both displays using the [Link] key. If either display is a two channel measurement (Transfer Function, Cross Spectrum Or Cross Correlation), then the End frequencies are automatically linked. If either measurement is Cross-Correlation, then the End frequency of both displays is set to the Span.

Command: FEND (?) d {, f}

Octave Frequency Menu

When the Measurement Group is Octave Analysis, this menu selects the number and spacing of frequency bands for the active display. See ‘Octave Analysis’ in Chapter 2 for a discussion about octave analysis fundamentals.

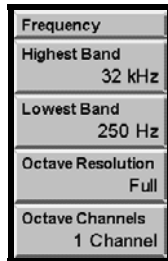

Highest Band

Set the Highest Band for the active display. The limits for the Highest Band are determined by the Octave Resolution and the number of Octave Channels.

1 Octave Channel

- 1/1 Octave: [125 mHz .. 32 kHz]
- 1/3 Octave: [160 mHz .. 40 kHz]
- 1/12 Octave: [190 mHz .. 12.34 kHz]

2 Octave Channels

- 1/1 Octave: [125 mHz .. 16 kHz]
- 1/3 Octave: [160 mHz .. 20 kHz]
- 1/12 Octave: [190 mHz .. 6.17 kHz]

The total power of all measured bands is displayed as a filled in band at the right side of the graph.

The exact band center frequencies are calculated according to the ANSI standard. The displayed frequencies are sometimes rounded to even values for a simpler display.

The measurement may span 1 to 11 octaves. Increasing the Highest Band will also increase the Lowest Band if necessary to keep the measurement span at 11 octaves.

The two displays can have different Highest Bands. This entry field can be linked to both displays using the [Link] key. Linking is only allowed if both displays have the same Octave Resolution.

Command: OHIB (?) d {, f}

Lowest Band

Set the Lowest Band for the active display. The limits for the Lowest Band are determined by the Octave Resolution.

1/1 Octave: [125 mHz ..]
1/3 Octave: [100 mHz ..]
1/12 Octave: [100 mHz ..]

The exact band center frequencies are calculated according to the ANSI standard. The displayed frequencies are the ANSI nominal center frequencies.

The measurement may span 1 to 11 octaves. Decreasing the Lowest Band will also decrease the Highest Band if necessary to keep the measurement span at 11 octaves.

The two displays can have different Lowest Bands. This entry field can be linked to both displays using the [Link] key. Linking is only allowed if both displays have the same Octave Resolution.

Command: OLOB (?) d {, f}

Octave Resolution

Select the Octave Resolution (number of bands per octave) for the active display [Full, Third, Twelfth].

Full octave band centers are calculated by multiplying or dividing 1000 Hz by 2.

Third octave band centers are calculated by multiplying or dividing 1000 Hz by $2^{1/3}$ or 1.2599.

Twelfth octave band centers are calculated by multiplying or dividing 1000 Hz by $2^{1/12}$ or 1.0595.

The exact band center frequencies are calculated according to the ANSI standard. The displayed frequencies are sometimes rounded to even values for a simpler display. The filter shapes are third-order Butterworth with full, 1/3 or 1/12 octave bandwidth.

Changing the Octave Resolution will change the Lowest Band and Highest Band to allowed bands of the new resolution.

The two displays can have different Octave Resolutions. This entry field can be linked to both displays using the [Link] key.

Command: ORES (?) d {, i}

Octave Channels

Select the number of input channels for the octave measurement. The number of Octave Channels affects the Measurements of both displays.

If 2 Octave Channels are selected, then both inputs may be analyzed. The Measurements of both displays are independent. The Highest Band for all Octave Resolutions is decreased by 2 in this case.

4-14 Octave Frequency Menu

If 1 Octave Channel is selected, then only one input may be analyzed. If both displays are making an octave measurement, they must both use the same input. Changing the input of the active display will change the Measurement or input of the other display if necessary. User Functions which use both inputs may not be measured. Choosing 1 Octave Channel may change the current Measurements so that both displays use the same input.

Command: OCHN (?) d {i}

Swept Sine Frequency Menu

When the Measurement Group is Swept Sine, this menu sets the frequency sweep parameters. These parameters govern the measurements on both displays. See ‘Swept Sine’ in Chapter 2 for a discussion about swept sine measurement fundamentals.

Frequency	
Start	1 kHz
Stop	20 kHz
Repeat	Continuous
Type	Linear
Auto Resolution	On
# of Points	200
Max Step Size	8
Faster Threshold	< 0.1 dB
Slower Threshold	> 0.5 dB

Start

Set the Start frequency [1 mHz .. 102.4 kHz]. Note that measurements at frequencies less than 1 Hz take a significant amount of time.

The Start frequency is usually less than the Stop frequency. If the Start frequency is greater than the Stop frequency, then the sweep proceeds downward from the Start frequency.

If the Start frequency is changed during a sweep, the sweep will be reset.

Command: SSTR d (,) {f}

Stop

Set the Stop frequency [1 mHz .. 102.4 kHz]. Note that measurements at frequencies less than 1 Hz take a significant amount of time.

The Stop frequency is usually greater than the Start frequency. If the Stop frequency is less than the Start frequency, then the sweep is downward from the Start frequency.

If the Stop frequency is changed during a sweep, the sweep will be reset.

Command: SSTP (?) d {, f}

4-16 Swept Sine Frequency Menu

Repeat

Select the Sweep Repeat Mode [Single Shot, Continuous].

In Single Shot mode, the measurement is paused at the completion of the sweep and the source ramps off.

In Continuous mode, the measurement is repeated at the completion of each sweep. The source moves immediately to the Start frequency and begins the sweep again. Data from the previous sweep is preserved on the display and can be examined with the cursor.

Command: SRPT (?) d {, i}

Type

Select the Sweep Type [Linear, Log].

Linear sweep computes the measurement points in a linear progression from the start to the stop frequency. Choosing linear sweep also sets the X axis to linear.

Log sweep uses a logarithmic progression of points from the start to the stop frequency. Choosing log sweep also sets the X axis to logarithmic.

Command: SSTY (?) d {, i}

Auto Resolution

Select Auto Resolution [Off, On].

If Auto Resolution is Off, all points in the sweep are measured.

Auto Resolution On allows the sweep to skip points if sequential points do not vary by more than a specified amount. Auto Resolution is specified by three parameters, the Faster Threshold, the Slower Threshold and the Maximum Step Size. These parameters can only be adjusted when Auto Resolution is On.

Auto Resolution examines the results of successive measurements. If the newest measurement is within the Faster Threshold of the previous measurement (for BOTH channels), then the sweep will take larger steps, skipping frequency points. Each successive time this threshold is met, the step size is increased until the Maximum Step Size is reached. This speeds up the sweep in regions where the response is flat (varies less than the Faster Threshold).

If a measurement differs from the previous measurement by more than the Slower Threshold (for EITHER channel), then the sweep returns to the previously measured point and moves to the very next frequency point in the sweep (with no skipping). The sweep continues from this point, speeding up if allowed and slowing down when required. This ‘fills’ in skips in the sweep which vary by more than the Slower Threshold.

Measurements which differ by more than the Faster Threshold (on EITHER channel) but less than the Slower Threshold (on BOTH channels), maintain the present sweep speed. The number of points skipped remains the same in this case.

If the marker position is displayed with a '?', the point has not actually been measured but is interpolated from actual measured points. The measurement of these points was skipped due to sweep Auto Resolution.

Command: SARS (?) d {, i}

Number of Points

Set the Number Of Points [10..2048]. The points are in a Linear or a Logarithmic progression as set by the Sweep Type.

If the Number Of Points is changed during a sweep, the sweep will be reset.

A sweep with a large number of points can detect narrow features. A sweep with a small number of points will take less time. In order to save time while maintaining a high resolution, use Auto Resolution.

Command: SNPS (?) d {, i}

Maximum Step Size

Set the Maximum Step Size for Auto Resolution frequency sweeps [2..256].

When Auto Resolution is On, each successive time the Faster Threshold condition is met (on BOTH channels), the frequency step size is increased until the Maximum Step Size is reached. This sets the maximum speed at which the sweep will continue until the Slower Threshold is exceeded.

Generally, this number should not exceed 5% of the Number Of Points in the sweep.

Command: SSKP (?) d {, i}

Faster Threshold

Set the Faster Threshold [0.01..3 dB].

Auto Resolution examines the results of successive measurements. If the newest measurement is within the Faster Threshold of the previous measurement for BOTH channels, then the sweep will take larger steps, skipping frequency points. Each successive time this threshold is met, the step size is increased until the Maximum Step Size is reached. This speeds up the sweep in regions where the response is flat (varies less than the Faster Threshold).

Measurements which differ by more than the Faster Threshold on EITHER channel, but less than the Slower Threshold on BOTH channels, maintain the present sweep speed.

4-18 Swept Sine Frequency Menu

Generally, the Faster Threshold should be set to the desired amplitude resolution. In order for skipping to occur, this should be something greater than the variations in the flattest regions of the measurement.

Command: SFST (?) d {, i}

Slower Threshold

Set the Slower Threshold [0.05..6 dB].

If Auto Resolution is skipping points and a measurement differs from the previous measurement by more than the Slower Threshold for EITHER channel, then the sweep returns to the previously measured point and moves to the very next frequency point in the sweep (with no skipping). The sweep continues from this point, speeding up if allowed and slowing down when required. This ‘fills’ in skips in the sweep which vary by more than the Slower Threshold.

Measurements which differ by more than the Faster Threshold on EITHER channel, but less than the Slower Threshold on BOTH channels, maintain the present sweep speed.

Generally, the Slower Threshold should be set to less than half of the smallest desired feature size (relative to the region before the feature). A good rule is to set the Slower Threshold at twice the Faster Threshold.

Command: SSLO (?) d {, i}

Display Setup Menu

The Display Setup menu allows the user to choose the Measurement, View and Display Scaling for the active display.

Display Setup	
Measure Group	FFT
Measurement	FFT ch1
View	Log Mag
Units	dBVpk
Y max	0
Y mid	-50
Y min	-100
Y/div	10
Pan	0
Zoom	x1

Measurement Group

Select the Measurement Group for both displays [FFT, Octave Analysis, Swept Sine]. To choose a specific measurement, choose the Measurement Group, then select a Measurement.

The FFT Measurement Group uses the Fast Fourier Transform (FFT) to compute the frequency spectrum of finite time records.

The Octave Analysis Measurement Group measures the power within logarithmically spaced frequency bands covering up to 11 octaves.

The Swept Sine Measurement Group uses the sine source to sweep a frequency range making optimized measurements at discrete frequency points along the way.

The Measurement Group may not be changed if the Input Source is Playback from capture. Change the Input Source to Analog to change the Measurement Group.

The choice of Measurement Group changes the [Frequency], [Average] and [Source] menus.

Command: MGRP(?) d {, i}

Measurement (FFT)

Select the Measurement of the active display when the Measurement Group is FFT.

Each Measurement has an associated View. Changing the Measurement changes the View to the View last used with the new Measurement.

The two displays generally have different Measurements. This entry field can be linked to both displays using the [Link] key. Choosing a two channel measurement (Transfer Function, Cross Spectrum, Cross Correlation Or Coherence) links the frequency parameters of the two displays.

Command: MEAS(?) d {, i}

The following Measurements are available in the FFT Measurement Group:

FFT

The FFT spectrum is the basic measurement of an FFT analyzer. It is simply the FFT of a time record. The spectrum is a complex quantity (it contains phase as well as amplitude information). This is sometimes referred to as the linear spectrum.

The phase of the spectrum is meaningful only if the time record is triggered with a fixed relationship to the input signal. If the signal is periodic as well (the signal and trigger repeat), then vector averaging can be used to reduce the noise level of the spectrum. The vector averaged spectrum is still a complex quantity.

The rms averaged spectrum is sometimes called the power spectrum. The power spectrum gives a stable (and usually more accurate measure) of the rms signal amplitudes as well as the rms noise levels.

Time Record

A time record is simply a sequence of data samples. The length of the time record is the FFT resolution/span.

For baseband spans (spans which start at DC), the time record resembles a digital oscilloscope display. Signals at frequencies above the span have been filtered out. Baseband time records are entirely real, they have no imaginary part.

For zoomed spans (spans which start above DC), the time record does NOT resemble the original data. The data has been frequency shifted. Signals at the center of the span appear at DC while frequencies at both edges of the span appear as high frequencies. Zoomed time records are complex, they have both a real and an imaginary part. The sampling rate is always half of the equivalent baseband span.

Remember, the time record is not a continuous representation of the input signal. The data is sampled and has a time resolution of $1/(\text{sample rate})$. High frequency signals will appear distorted in the time record. However, ALL of the spectral information is preserved by the Nyquist sampling theorem as long as the value of each sample is accurate. A triggered time record will always jitter by 1 sample. This jitter is removed in the computation of the phase of the spectrum relative to the trigger.

Averaging does not affect the time record. Averaging is performed on the FFT spectrum and not on the time data.

Amplitude calibration is also performed in the frequency domain. Hence, the time data amplitudes are not calibrated.

Windowed Time Record

The FFT operates on windowed time records. The window function is applied to the time record immediately before the FFT. Most window functions taper off to zero at the start and end of the time record. If a transient signal occurs at the start of the time record, the corresponding windowed time record and FFT may not show anything because the window function reduces the transient to zero.

Orbit

The Orbit measurement is a two channel measurement whose real part is the real part of Time Record Ch1 and whose imaginary part is the real part of Time Record Ch2. Orbit is normally displayed with the Nyquist View (Time2 vertical vs Time1 horizontal).

For baseband spans, the time records are entirely real and the Nyquist view of the Orbit measurement is a Lissajous figure.

Cross Spectrum

The cross spectrum (sometimes called cross power spectrum) is a two channel measurement defined as

$$\text{Cross Spectrum} = \text{Avg}(\text{conj}(\text{FFT1}) \cdot \text{FFT2})$$

where $\text{Avg}()$ is the averaging selected in the [Average] menu.

The cross spectrum contains both magnitude and phase information. The phase is the relative phase (at each frequency) between the two channels. Vector averaging can be used to eliminate signals which do not have a constant phase relationship between the two channels. In this case, triggering is not required for vector averaging.

The magnitude is simply the product of the magnitudes of each spectrum. Frequencies where signal is present in both spectra will have large components in the cross spectrum.

Transfer Function

The transfer function (sometimes called frequency response) is a two channel measurement which ratios the spectrum of Ch 2 to the spectrum of Ch 1. Transfer function measures the response of a network or device under test. The reference channel (1) measures the signal at the input to the device and the response channel (2) measures the device output. The result is the complex transfer function of the device.

There are two types of transfer function which differ in their averaging.

<F2/F1>

$$\langle F2/F1 \rangle = \text{Avg}(\text{FFT2} / \text{FFT1})$$

where $\text{Avg}()$ is the averaging selected in the [Average] menu.

The transfer function contains both magnitude and phase information. The phase is the relative phase (at each frequency) between the two channels. Vector averaging can be

used to eliminate signals which do not have a constant phase relationship between the two channels. In this case, triggering is not required for vector averaging.

$\langle F2/F1 \rangle$ is best used with coherent sources such as Chirp.

$\langle F2 \rangle / \langle F1 \rangle$

$$\langle F2 \rangle / \langle F1 \rangle = \text{Avg}(\text{FFT2}) / \text{Avg}(\text{FFT1})$$

where Avg() is the averaging selected in the [Average] menu.

In this case, each FFT is averaged separately and thus vector averaging does not preserve cross channel phase relationships on a time record by time record basis. In this case, triggering is required for vector averaging.

$\langle F2 \rangle / \langle F1 \rangle$ is best used with incoherent sources such as Noise.

Coherence

The coherence function is a two channel measurement defined as

$$\text{Coherence} = \text{Mag}^2(\text{VecAvg}(\text{CrossSpec})) / (\text{Pwr1} \cdot \text{Pwr2})$$

where CrossSpec = conj(FFT1) • FFT2 and PwrN = Mag²(RMSAvg(FFTN)).

Averaging is always On and the Averaging Modes are defined by the measurement above. The Type and Number Of Averages are still selected in the [Average] menu.

Coherence is a unitless real quantity and varies from 1.0 (perfect coherence) to 0.0 (no coherence). Coherence measures the percentage of power in the response channel (2) which is caused by (phase coherent with) power in the reference or input channel (1). Ideally, a coherence of 1.0 means that the corresponding transfer function is completely legitimate. All of the response power came from power at the input. If there is noise or other signals generated from within the device under test (which is not related to the input signal), it will result in a coherence of less than 1.0.

Auto Correlation

Auto correlation is a single channel measurement. In the time domain, it is a comparison of a signal x(t) with a time shifted version of itself x(t-τ) displayed as a function of τ. This is useful for detecting similarities which occur at different times. For example, echoes show up as peaks separated by the echo time. Sine waves appear as sine waves and square waves appear as triangles. Signals which do not repeat or are completely random for all time appear only at τ = 0.

The definition of Auto Correlation depends upon the Average Mode selected in the [Average] menu.

Averaging Off

$$\text{Auto Correlation} = \text{invFFT}(\text{FFTu N} \cdot \text{conj}(\text{FFT N}))$$

Peak Hold or RMS Averaging On

$$\text{Auto Correlation} = \text{invFFT}(\text{VecAvg}(\text{FFTu N} \cdot \text{conj}(\text{FFT N})))$$

Vector Averaging On

$$\text{Auto Correlation} = \text{invFFT}(\text{VecAvg}(\text{FFTu N}) \cdot \text{conj}(\text{VecAvg}(\text{FFT N})))$$

where N is Channel 1 or 2. FFT is a windowed FFT and FFTu is an un-windowed FFT (uniform window).

Correlation is a real function and requires a baseband span (real time record). Non-baseband time records do not preserve the original signal frequencies and thus do not yield the correct correlation. A display which is measuring a single channel correlation will have its start frequency set to 0 Hz. A display which measures cross correlation will set the start frequency of both displays to 0 Hz.

A window is applied to the time record of the first FFT in the computation. This is because the FFT models the time domain as a single time record repeating itself over and over. Computing the correlation over a τ greater than half of the time record length will result in ‘wrap around’ errors where data starts to repeat itself. To avoid this, special windows which zero half of the time record are used. The $[0..T/2]$ window zeroes the second half of the time record and the $[-T/4..T/4]$ window zeroes the first and last quarter of the time record. The $[-T/2..T/2]$ is a uniform window which should only be used on data which is self windowing (lasts less than half of the time record).

Cross Correlation

Cross correlation is a two channel measurement. In the time domain, it is a comparison of a signal $x(t)$ with a time shifted version of another signal $y(t-\tau)$ displayed as a function of τ . This is useful for measuring time delays between two common signals.

The definition of Cross Correlation depends upon the Average Mode selected in the [Average] menu.

Averaging Off

$$\text{Cross Correlation} = \text{invFFT}(\text{FFTu2} \cdot \text{conj}(\text{FFT1}))$$

Peak Hold or RMS Averaging On

$$\text{Cross Correlation} = \text{invFFT}(\text{VecAvg}(\text{FFTu2} \cdot \text{conj}(\text{FFT1})))$$

Vector Averaging On

$$\text{Cross Correlation} = \text{invFFT}(\text{VecAvg}(\text{FFTu2}) \cdot \text{conj}(\text{VecAvg}(\text{FFT1})))$$

where FFT1 is the windowed FFT of Channel 1 and FFTu2 is the un-windowed FFT (uniform window) of Channel 2.

Correlation is a real function and requires a baseband span (real time record). Non-baseband time records do not preserve the original signal frequencies and thus do not yield the correct correlation. A display which is measuring a single channel correlation will have its start frequency set to 0 Hz. A display which measures cross correlation will set the start frequency of both displays to 0 Hz.

A correlation window is applied to the time record of the first FFT in the computation. This is because the FFT models the time domain as a single time record repeating itself over and over. Computing the correlation over a τ greater than half of the time record length will result in ‘wrap around’ errors where data starts to repeat itself. To avoid this,

special windows which zero half of the time record are used. The $[0..T/2]$ window zeroes the second half of the time record and the $[-T/4..T/4]$ window zeroes the first and last quarter of the time record. The $[-T/2..T/2]$ is a uniform window which should only be used on data which is self windowing (lasts less than half of the time record).

Capture

The capture buffer stores sequential time domain data in memory. See 'Capture' in Chapter 2 for more details. The capture measurement displays the contents of the capture buffer. FFT measurements can use this stored data as input data by choosing Playback as the Input Source in the [Input] menu.

The capture buffer often stores many time records. To graphically expand a region of the display, use the Pan and Zoom functions in the [Display Setup] menu. The capture buffer display will automatically pan as the capture fill and playback progress through the buffer. During capture fill, if the capture buffer contains more points than can be displayed, points are skipped. This speeds up the display update so that it keeps up with the real time capture but allows visual aliasing to occur. Once capture is complete, the display is redrawn showing the envelope of all points, eliminating any visual aliasing effects.

To measure from a region of the buffer, set the Playback Start and Length in the [Input] menu.

The capture data is filtered and down-sampled according to the capture Sample Rate. Only baseband data (data bandwidth starts at DC) are captured. The capture buffer resembles a digital oscilloscope display. Signals at frequencies above $1/2.56$ times the sample rate have been filtered out.

The capture buffer is not a continuous representation of the input signal. The data is sampled and has a time resolution of $1/(\text{sample rate})$. High frequency signals will appear distorted in the time record. However, ALL of the spectral information (up to $1/2.56$ times the Sample Rate) is preserved by the Nyquist theorem as long as the value of each sample is accurate.

Amplitude calibration is performed in the frequency domain. Hence, the captured time data amplitudes are not calibrated.

User Functions

A User Function displays the results of a user defined math function. User Functions defined within the FFT Measurement Group may include FFT measurement results. Use the [User Math] menu to define a function.

A User Function may not be selected as the measurement if it uses a Trace which is empty or which contains data taken in a different Measurement Group.

See 'User Math Functions' in Chapter 2 for more.

Measurement (Octave Analysis)

Select the Measurement of the active display when the Measurement Group is Octave Analysis.

Each Measurement has an associated View. Changing the Measurement changes the View to the View last used with the new Measurement.

Command: MEAS(?) d {, i}

The following Measurements are available in the Octave Analysis Measurement Group:

Octave Spectrum

The octave spectrum is the basic measurement of octave analysis. It is simply the rms averaged outputs from the parallel bank of octave filters (also called the power spectrum). The spectrum gives a stable reading of the rms signal amplitudes and noise levels within each band. RMS averaging results in a real spectrum and there is no phase information.

Capture

The capture buffer stores sequential time domain data in memory. See 'Capture' in Chapter 2 for more details. The Capture measurement displays the contents of the capture buffer. Octave measurements can use this stored data as input data by choosing Playback as the Input Source in the [Input] menu.

The capture buffer is often very long. To graphically expand a region of the display, use the Pan and Zoom functions in the [Display Setup] menu. The capture buffer display will automatically pan as the capture fill and playback progress through the buffer. During capture fill, if the capture buffer contains more points than can be displayed, points are skipped. This speeds up the display update so that it keeps up with the real time capture but allows visual aliasing to occur. Once capture is complete, the display is redrawn showing the envelope of all points, eliminating any visual aliasing effects.

To measure from a region of the buffer, set the Playback Start and Length in the [Input] menu.

The capture data is filtered and down-sampled according to the capture sample rate. Only baseband data (data bandwidth starts at DC) are captured. The capture buffer resembles a digital oscilloscope display. Signals at frequencies above 1/2.56 times the sample rate have been filtered out.

The capture buffer is not a continuous representation of the input signal. The data is sampled and has a time resolution of 1/(sample rate). High frequency signals will appear distorted in the time record. However, ALL of the spectral information (up to 1/2.56 times the Sample Rate) is preserved by the Nyquist theorem as long as the value of each sample is accurate.

Amplitude calibration is performed in the frequency domain. Hence, the captured time data amplitudes are not calibrated.

User Functions

A User Function displays the results of a user defined math function. User Functions defined within the Octave Analysis Measurement Group may include octave measurement results. Use the [User Math] menu to define a function.

A User Function may not be selected as the measurement if it uses a Trace which is empty or which contains data taken in a different Measurement Group.

See 'User Math Functions' in Chapter 2 for more.

Measurement (Swept Sine)

Select the Measurement of the active display when the Measurement Group is Swept Sine.

Each Measurement has an associated View. Changing the Measurement changes the View to the View last used with the new Measurement.

Command: MEAS(?) d {, i}

The following Measurements are available in the Swept Sine Measurement Group:

Spectrum

The swept sine spectrum is simply the measurement of a single channel over a sweep. The spectrum is complex (it contains phase and amplitude information). The phase is relative to the source and is stable but arbitrary. Single channel phase is not generally meaningful.

The spectrum measures the actual signal level at the inputs. If source auto level is On, then the spectrum will tend to be constant. Use transfer function to remove the effects of a changing source level.

Cross Spectrum

The swept sine cross spectrum is a two channel measurement defined as

$$\text{Cross Spectrum} = \text{conj}(\text{Spec1}) \cdot \text{Spec2}$$

The cross spectrum contains both magnitude and phase information. The phase is the relative phase (at each frequency) between the two channels.

The magnitude is simply the product of the magnitudes of each spectrum. Frequencies where signal is present in both spectra will have large components in the cross spectrum.

Transfer Function

The swept sine transfer function (sometimes called frequency response) is a two channel measurement defined as

$$\text{Transfer Function} = \text{Spec2} / \text{Spec1}$$

The transfer function contains both magnitude and phase information. The phase is the relative phase (at each frequency) between the two channels.

Transfer function measures the response of a network or device under test. The reference channel (1) measures the signal at the input to the device and the response channel (2) measures the device output. The result is the complex transfer function of the device.

User Functions

A User Function displays the results of a user defined math function. User Functions defined within the Swept Sine Measurement Group may include swept sine measurement results. Use the [User Math] menu to define a function.

A User Function may not be selected as the measurement if it uses a Trace which is empty or which contains data taken in a different Measurement Group.

See 'User Math Functions' in Chapter 2 for more.

View

Select the View of the active display Measurement. A View is a way of looking at complex measurement data.

Each display has its own Measurement and each Measurement has an associated View. Changing Measurements changes the View to the View associated with the new Measurement. The two displays generally have different Measurements each with their own associated Views. This entry field can be linked to the Measurement on both displays using the [Link] key.

Command: VIEW (?) d {, i}

The following Views are available:

Log Magnitude

Log magnitude view graphs the log of the magnitude of the measurement data. The magnitude is simply $\sqrt{x^2 + y^2}$ where x is the real part and y is the imaginary part. The Y axis of the display is logarithmic in scaling.

Linear Magnitude

Linear magnitude view graphs the magnitude of the measurement data. The magnitude is simply $\sqrt{x^2 + y^2}$ where x is the real part and y is the imaginary part. The Y axis of the display is linear in scaling.

Magnitude²

Magnitude² view graphs the magnitude squared of the measurement data. The magnitude squared is simply $(x^2 + y^2)$ where x is the real part and y is the imaginary part. The Y axis of the display is linear in scaling.

Real Part

Real Part view graphs the real part of the measurement data. The Y axis of the display is linear in scaling.

Imaginary Part

Imag Part view graphs the imaginary part of the measurement data. The Y axis of the display is linear in scaling.

Real measurement data, such as baseband time record, have zero imaginary part. This view is zero for all points.

Imaginary data arises from the multiplication of the time data by sine and cosine (heterodyne and FFT). Signals in phase with cosine result in real data, signals in phase with sine result in imaginary data. The real and imaginary parts represent data 90 degrees out of phase.

Phase

Phase view graphs the phase of the measurement data. The phase is a four-quadrant quantity defined as $\theta = \arctan(y/x)$ where y is the imaginary part and x is the real part and x is positive. If x is negative, an additional 180 deg. is added to the phase. Phase is graphed linearly from -180 ($-\pi$) to +180 (π) degrees (radians). To show unwrapped phase, choose the Unwrapped Phase view.

Real measurement data, such as baseband time record, have zero imaginary part. The phase is zero for all points.

Single channel phase is relative to the center of the time record for Uniform, BMH, Hanning, Flattop and Kaiser windows. For Force and Exponential windows, phase is relative to the start of the time record. In general, single channel phase is useful only when the time record is triggered in phase with the signal.

For two channel measurements, the phase is channel 2 relative to channel 1. Triggering is not generally required for meaningful two channel phase measurements.

Phase suppress sets the phase of small data values to zero. This avoids the messy phase display associated with the noise floor. (Remember, even a small signal has phase.) Set the phase suppress threshold in the [Display Options] menu.

The FFT can be thought of as a set of bandpass filters, each centered on a frequency bin. The signal within each filter shows up as the amplitude of each bin. If a signal's frequency is between bins, the filters cause phase errors. Because these filters are very steep and selective, they introduce very large phase shifts for signals not exactly on a frequency bin. Use the SR780 source to generate exact bin frequencies whenever possible.

Unwrapped Phase

Unwrapped Phase view graphs the phase of the measurement data as a continuous function without 'wrapping' around at ± 180 degrees. This view is generally meaningful only for measurements which have data at every frequency point (such as chirp source or swept sine).

The phase θ is calculated for each point as in the 'wrapped' Phase view. The value of $\theta \pm (n \times 360 \text{ deg.})$ which is closest to the phase of the previous point is assigned to each point (n is an integer). The wrapping starts at the left edge of the display.

Single channel phase is relative to the center of the time record for Uniform, BMH, Hanning, Flattop and Kaiser windows. For Force and Exponential windows, phase is relative to the start of the time record. In general, single channel phase is useful only when the time record is triggered in phase with the signal.

For two channel measurements, the phase is channel 2 relative to channel 1. Triggering is not generally required for meaningful two channel phase measurements.

Phase suppress sets the phase of small data values to zero. This avoids the messy phase display associated with the noise floor. (Remember, even a small signal has phase.) Set the phase suppress threshold in the [Display Options] menu.

Nyquist Plot

The Nyquist plot graphs complex measurement data as imaginary part (along the Y axis) versus real part (along the X axis). The graph is scaled linearly. Adjacent frequency points are connected by a line. This view is generally meaningful only for measurements which have data at every frequency point (such as chirp source or swept sine).

The marker readout shows the real and imaginary parts of each point as well as its frequency. The marker moves sequentially through the frequency points and can be linked to the frequency of the other display.

Real measurement data, such as baseband time record, have zero imaginary part. This view is entirely along the X axis.

Nichols Plot

The Nichols plot graphs complex measurement data as log magnitude (along the Y axis) versus unwrapped phase (along the X axis). The Y axis is logarithmic and the X axis is linear. Adjacent frequency points are connected by a line. This view is generally meaningful only for measurements which have data at every frequency point (such as chirp source or swept sine).

The marker readout shows the log magnitude and phase of each point as well as its frequency. The marker moves sequentially through the frequency points and can be linked to the frequency of the other display.

Real measurement data, such as baseband time record, have zero phase. This view is entirely along the Y axis.

Units

Select the Units of the active display View.

The choice of units is limited to those which are appropriate for the Measurement and View.

dBspl is only available if the EU Label for the measured input is Pascals.

4-30 Display Setup Menu

Units are associated with the Measurement and its associated View. Changing Measurements or Views may change the Units.

The two displays may have different Units. This entry field can be linked to both displays using the [Link] key as long as both displays have the same available units.

Command: UNIT (?) d {, i}

Y Max

Set the Y Maximum (top reference) of the active display. The top reference is the Y value of the top of the graph. The top reference has the same units as the display.

The two displays can have different top reference values. This entry field can be linked to both displays using the [Link] key.

Command: YMAX (?) d {, x}

Y Mid

Set the Y Midpoint (center reference) of the active display. The center reference is the Y value of the center of the graph. The center reference has the same units as the display.

The two displays can have different center reference values. This entry field can be linked to both displays using the [Link] key.

Command: YMID (?) d {, x}

Y Min

Set the Y Minimum (bottom reference) of the active display. The bottom reference is the Y value of the bottom of the graph. The bottom reference has the same units as the display.

The two displays can have different bottom reference values. This entry field can be linked to both displays using the [Link] key.

Command: YMIN (?) d {, x}

Y / Div

Set the Y/Division scale of the active display. This value is the vertical scale of the graph.

The knob adjusts the vertical scale in a 1-2-5-10 sequence. Knob adjustments set the Y Midpoint (center reference) to the current Marker X Position. The Y Maximum and Y Minimum are adjusted to give the effect of vertical zooming. Entering a scale numerically leaves the Y Min (bottom reference) unchanged. The Y Max and Y Mid are adjusted.

If the View is scaled linearly, the vertical scale is expressed in the display units. If the View is logarithmic, the vertical scale is always dB/division. In this case, the reference values (Y Max, Mid and Min) are still shown in the display units.

The two displays can have different vertical scales. This entry field can be linked to both displays using the [Link] key.

Command: YDIV (?) d {, x}

X Center (Polar)

Set the X Center of the active display when the View is Nyquist or Nichols plot. The X Center is the X axis value at the center of the graph. The X Center has the same units as the display.

The two displays can have different X Center values. This entry field can be linked to both displays using the [Link] key.

Command: XCEN (?) d {, x}

X / Div (Polar)

Set the X/Division scale of the active display when the View is Nyquist or Nichols plot. This value is the horizontal scale of the graph. The knob adjusts the scale in a 1-2-5-10 sequence. Changing the scale does not change the X Center location.

The X axis is scaled linearly and the scale is expressed in the display units.

The two displays can have different scales. This entry field can be linked to both displays using the [Link] key.

Command: XDIV (?) d {, x}

Y Center (Polar)

Set the Y Center of the active display when the View is Nyquist or Nichols plot. The Y Center is the Y axis value at the center of the graph. The Y Center has the same units as the display.

The two displays can have different Y Center values. This entry field can be linked to both displays using the [Link] key.

Command: YCEN (?) d {, x}

Y / Div (Polar)

Set the Y/Division scale of the active display when the view is Nyquist or Nichols plot. This value is the vertical scale of the graph. The knob adjusts the scale in a 1-2-5-10 sequence. Changing the scale does not change the Y Center location.

4-32 Display Setup Menu

If the Y axis is scaled linearly, the vertical scale is expressed in the display units. If the Y axis is logarithmic, the vertical scale is always dB/division.

The two displays can have different scales. This entry field can be linked to both displays using the [Link] key.

Command: Y2DV (?) d {, x}

Pan

Set the Pan (translation) of the active display. This value is the left most displayed bin when the X axis is Zoomed (expanded).

The two displays can have different translations when expanded. This entry field can be linked to both displays using the [Link] key.

Command: XPAN (?) d {, i}

Zoom

Select the Zoom factor (X axis expand) of the active display. 'Expand' is shown in the display whenever it is expanded.

Expanding the X axis is a convenient way of examining closely spaced details in a display without changing the measurement. Expansion is about the Marker Position whenever possible. Use Pan to translated a zoomed display.

Zoom is not allowed when the X axis is logarithmic or when the View is polar (Nyquist or Nichols plot).

The two displays can have different Zoom values when expanded. This entry field can be linked to both displays using the [Link] key.

Command: XZOM (?) d {, i}

Display Options Menu

The Display Options menu configures the active display format.

Display Options	
Display	Live
Format	Dual
X-Axis	Linear
Grid	On
Grid Div	10
PSD Units	Off
Transducer Convert Acceleration	
dBm Ref. Imped.	50
Phase Suppress	0.0000e+000
d/dx window (%)	0.5

Display

Select the Display Update of the active display [Live, Off-Line].

A Live display updates continuously to show live measurement results (as long as the measurement is not paused).

An Off-Line display does not update. The display shows a 'frozen' measurement result or trace. A display becomes Off-Line whenever a trace is recalled to the display from disk or memory. Since an Off-Line display is showing old data, its Measurement, Window, Frequency Span and Averaging may not be modified. Only display related parameters such as View, Scaling and Marker Functions may be changed Off-Line.

The two displays can have different Display Update Modes. This entry field can be linked to both displays using the [Link] key.

A single display may be taken Off-Line while the other display is still Live. This allows comparison of live results with a previous result. This is unlike the [Pause/Cont] key which pauses ALL measurements.

Command: DISP (?) d {, i}

Format

Select the screen Display Format [Single or Dual].

4-34 Display Options Menu

In Single format, the active display is shown. Use the [Active Display] key to switch between DisplayA and DisplayB.

In Dual format, DisplayA is always on top. The [Active Display] key switches the active display from top (A) to bottom (B).

Command: DFMT (?) {i}

X-Axis

Select the X Axis Scale Type for the active display [Linear, Logarithmic].

Logarithmic scaling is only available for FFT measurements with frequency as the X axis. Displaying a measurement with a time axis (Time Record, Capture or Correlation) will change the scaling to linear (and disable this softkey).

Octave Analysis is always displayed on a logarithmic X axis. The X axis type for Swept Sine measurements is set by the Sweep Type. This softkey is disabled for the Octave Analysis and Swept Sine Measurement Groups.

The logarithmic scale does not affect the frequency bins of the FFT measurement. The resolution is still linear. The points are simply graphed with a logarithmic axis. DC bins are not shown.

The two displays can be scaled differently. This entry field can be linked to both displays using the [Link] key.

Command: XAXS (?) d {, i}

Grid

Select the Grid for the active display [On, Off].

The grid is the set of dotted lines on the display which mark each scale division.

The two displays have their own Grid. This entry field can be linked to both displays using the [Link] key.

Command: GRID (?) d {, i}

Grid Div

Select the number of Grid Divisions for the active display [8, 10, 12, 15].

Changing the number of Grid Divisions changes the vertical scaling (Y/div) and leaves the display references unchanged. If the view is polar, the horizontal scaling (X/div) is also changed. Change the scaling in the [Display Setup] menu.

The two displays have their own number of Grid Divisions. This entry field can be linked to both displays using the [Link] key.

Command: GDIV (?) d {, i}

PSD Units

Select PSD Units for the active display [On, Off].

Power Spectral Density (PSD) is the energy in each frequency bin normalized to the noise bandwidth of the bin. The noise bandwidth is calculated from the FFT Linewidth and the Window function. This compensates measurements with different Spans and Windows. The units of the display are V^2/Hz or V/\sqrt{Hz} .

PSD is only available for frequency domain FFT measurements. Choosing a time domain, Octave Analysis or Swept Sine measurement turns PSD Units off and disables this softkey.

PSD units are used in noise measurements. Most white noise sources are specified by their noise spectral density.

The two displays have their own PSD Units mode. This entry field can be linked to both displays using the [Link] key.

Command: PSDU (?) d {, i}

Transducer Convert

Select the Transducer Conversion for the active display [Acceleration, Velocity, Displacement]. Transducer Convert only has an effect for measurements of inputs with Transducer Units of acceleration, velocity or displacement. Transducer Convert is not available for Octave Analysis measurements.

Transducers (such as accelerometers) convert a physical quantity (such as acceleration) into a voltage at the analyzer's input. By assigning Transducer Units to an input, measurements based upon the transducer signal may be displayed in units of the actual physical quantity being measured (such as m/s^2 or in/s^2).

Transducer Convert allows measurements of inputs which are assigned input units of acceleration, velocity or displacement to be displayed with ANY of these three units. The conversion is accomplished in the frequency domain by multiplying by $j\omega$ to differentiate with respect to time and dividing by $j\omega$ to integrate over time.

The two displays have their own Transducer Conversion. This entry field can be linked to both displays using the [Link] key.

Command: TDRC (?) d {, i}

dBm Reference Impedance

Set the dBm Reference Impedance for both displays [Ohms].

The dBm Reference Impedance is used to calculate dBm units. dBm is simply $10 \cdot \log(\text{power}/1\text{mW})$ where $\text{power} = V_{\text{rms}}^2/\text{Reference Impedance}$.

Command: DBMR (?) {x}

Phase Suppress

Set the Phase Suppress Threshold for the active display [0..]. When the display View is Phase or Unwrapped Phase, the phase of data points with a squared magnitude less than the threshold are displayed as zero. This avoids the messy phase display associated with the noise floor. (Remember, even a small signal has phase.)

To display the phase of all points, set the threshold to 0.0.

To suppress the phase of signals below -60 dBV (1.0E-3 V), set the threshold to 1.0E-6 V² (magnitude squared).

The two displays have their own Phase Suppress Threshold. This entry field can be linked to both displays using the [Link] key.

Command: PHSL (?) d {, x}

d/dx Window

Set the d/dx Window for the active display as a percentage of the display length [0.0005..10].

The percentage is converted to a number of display bins (minimum of 1) and the aperture is 2 times this number plus 1. The aperture is used in the calculation of d/dx and group delay in user math functions. Larger windows result in smoother graphs with less x-axis resolution.

Derivative calculations are not available in Octave Analysis measurements and this menu box cannot be changed.

The two displays have their own d/dx Window. The same function may viewed in the two displays with different d/dx windows. This entry field can be linked to both displays using the [Link] key.

Command: DDXW (?) d {, x}

Marker Menu

The Marker menu configures the display markers. Marker functions such as Harmonic Distortion, Sideband Power or Band Analysis are available in this menu.

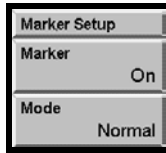

Marker

Select the Marker Tracking of the active display [Off, On, Track, Link].

Off turns the Marker off. It may be desirable to do this before printing the display.

On turns the Marker on. Use the knob (whenever no entry is pending) to move the Marker Region.

Track automatically moves the Marker position to the maximum point in the display. For Normal Marker, minimum tracking is also available by choosing Minimum for the Marker Seeks selection.

Link moves the Marker Region in the other display with the Marker Region in this display. The marker setup of the other display still configures its marker display.

Each display has its own Marker Tracking. This entry field can be linked to both displays using the [Link] key.

Command: MRKR (?) d {, i}

Mode

Select the Marker Mode of the active display [Normal, Harmonic, Sideband, Band]. Choosing the Marker Mode also configures the rest of this menu.

FFT measurement group can use any Marker Mode.

Octave measurement group can use Normal and Band modes only.

Swept Sine measurement group can only use Normal mode.

Each display has its own Marker Mode. This entry field can be linked to both displays using the [Link] key.

Command: MKMD (?) d {, i}

Normal

The Normal Marker Mode defines a Marker Region between two solid vertical lines. The Width may be set to a single point (Spot) or 1/2 (Normal) or 1 (wide) grid division. The Marker is a small square which Seeks the Max, Min or Mean of the data within the Marker Region.

When seeking Max or Min, the Marker is located at the max or min data point. This allows peaks and valleys in the display to be easily read by the Marker Position display (above the graph). When the Marker Seeks the Mean, the X position is the center of the Marker Region and the Y position is the Mean of the data within the region.

When a Spot Marker is used, the Marker is confined to a single X axis location.

Use [Marker Max] or [Marker Min] to move the Marker to the maximum or minimum of the graph.

The Marker Position display above the graph shows the X position (frequency or time) and the Y value (amplitude) of the Marker.

The knob moves the Marker Region of the active display whenever there is no pending entry. When the display is a Waterfall, use [Alt] knob to move the marker from record to record (along the Z axis) and scroll the display through the waterfall memory. Use the knob (without [Alt]) to move the marker along the X axis within a record.

Harmonic

The Harmonic Marker Mode defines a Fundamental Marker with a solid vertical line. In addition to the Fundamental Marker, a number of harmonics are identified by small triangular Harmonic Markers. The Marker Position Display can show the position of the Fundamental or of a single Harmonic.

The Total Harmonic Distortion (THD) is calculated within the [Marker] menu (in dB and percent). Only those harmonics within the measurement span which are identified by Harmonic Markers contribute to the THD. The Harmonic Power (in Vrms) is also shown. To measure THD+N, use Band Marker.

Harmonic Marker is only available for FFT measurements in the frequency domain.

The knob moves the Fundamental Marker of the active display whenever there is no pending entry. Use [Marker Max] to move the Fundamental Marker to the peak of the graph. The harmonic identification works best if the fundamental frequency is a bin frequency. If the fundamental is off-bin, then it is best to use the Flattop window to broaden all of the peaks.

Harmonic Marker is not available for Octave or Swept Sine measurement groups.

Sideband

The Sideband Marker Mode defines a Fundamental (carrier) Marker with a solid vertical line. In addition to the Fundamental Marker, a number of sidebands (discrete frequencies) are identified by small triangular Sideband Markers. The Marker Position Display can show the position of the Fundamental or of a single Sideband.

The Sideband Power is calculated within the [Marker] menu (in display units and dB). Only those sidebands within the measurement span which are identified by the Sideband Markers contribute to the Sideband Power.

Sideband Marker is only available for FFT measurements in the frequency domain.

The knob moves the Fundamental Marker of the active display whenever there is no pending entry. Use [Marker Max] to move the Fundamental Marker to the peak of the graph. The sideband identification works best if the fundamental frequency is a bin frequency. If the fundamental is off-bin, then it is best to use the Flattop window to broaden all of the peaks.

Sideband Marker is not available for Octave or Swept Sine measurement groups.

Band

The Band Marker Mode defines two frequency bands in the display. The Upper (2) band is delimited by dashed vertical markers and the Lower (1) band with solid vertical markers. The pairs of vertical markers are connected by shaded bands at the bottom of the graph. These shaded bands define the bins within the Upper and Lower bands.

Use <Modify Band> to modify either the Upper or Lower band. Use the knob to move selected band. Use [Alt] knob to re-size the selected band.

The two Band Powers are calculated within the [Marker] menu (in Vrms). Only those frequencies within the two band limits contribute to the Band Powers.

Band Exclude can be used to remove a small band from a larger band. For example, exclude '2from1' excludes those bins in the Upper band from the Lower band. The Lower Band Power only includes those bins in the Lower band which are not also in the Upper band.

The Band Ratio is the ratio of the Upper Band Power to either the Lower Band Power or the sum of the two band powers. The ratio is displayed in % and dB.

Band Ratio can be used to measurement THD+N. In this case, use the Lower (1) band to define a small region around the fundamental and the Upper (2) band to define the total bandwidth of interest. Exclude '1from2' so the Upper (2) band does not measure the fundamental. Choose the $2/(1+2)$ ratio mode to measure THD+N (power with fundamental notched out/total power including fundamental).

Band Marker is only available for frequency domain FFT and Octave measurements.

Band Marker is not available for Octave measurement groups.

Normal Marker Menu

This menu is displayed when the active display Marker Mode is Normal.

Marker Setup	
Marker	On
Mode	Normal
Seeks	Max
Width	Spot
Rel	Off
X-Rel	0
Y-Rel	0
X-Rel	Off

Seeks

Select the Normal Marker Seeks mode of the active display [Max, Min, Mean].

The Marker searches the data points within the Marker Region for the Maximum or Minimum data value or calculates the Mean of the region. The results are shown in the Marker Position display above the graph. When Seeking Max or Min, the Marker is located at the max or min data point. When the Seeking the Mean, the X position is the center of the Marker Region and the Y position is the Mean of the data within the region.

Each display has its own Marker Seeks Mode. This entry field can be linked to both displays using the [Link] key.

Command: MSEK (?) d {, i}

Width

Select the Normal Marker Width of the active display [Spot, Normal, Wide].

The Normal Marker Mode defines a Marker Region between two solid vertical lines. The Width may be set to a single point (Spot) or 1/2 (Normal) or 1 (Wide) grid division. The Marker is the small square which Seeks the Max, Min or Mean of the data within the Marker Region.

Each display has its own Normal Marker Width. This entry field can be linked to both displays using the [Link] key.

Command: MWID (?) d {, i}

Rel

Select the Normal Marker Rel Mode of the active display [Off, Relative, Reference Display, Other Display].

The Marker Position display above the graph shows the X position (frequency or time) and the Y value (amplitude) of the Marker. A relative reading is preceded by a Δ (delta) symbol.

The X position may be shown absolute or relative in all cases as selected by <X-Rel>.

Off displays the absolute marker position.

Relative calculates the marker position relative to the Marker Offset (X-Rel, Y-Rel). The Marker Offset location (if it is within the display) is marked by a small flag shaped symbol.

Reference Display calculates the marker position relative to the Reference Display. The X position is absolute and the Y position is offset by the Reference Display value at the X position. Ref. Disp. is only available if the Reference Display is On.

Other Display calculates the marker position relative to the other display's marker position. The marker offset is just the marker position of the other display. This is generally valid only if the two displays have a similar measurement.

Pressing [Marker Ref] changes from Off to Rel. and sets the Marker Offset to the current Marker Position. [Marker Ref] again changes from Rel. back to Off. [Marker Ref] does not change the other modes.

Each display has its own Normal Marker Rel Mode. This entry field can be linked to both displays using the [Link] key.

Command: MREL (?) d {, i}

X-Rel

Set the X Offset for the Normal Marker of the active display.

When the Marker Rel Mode is Relative, the marker position is calculated relative to the Marker Offset (X-Rel, Y-Rel). The Marker Offset location (if it is within the display) is marked by a small flag shaped symbol.

The Marker Offset has no associated units. The relative calculation simply subtracts the Marker Offset (in the display units) from the absolute marker position. Changing the display units invalidates the Marker Offset. Re-enter the Marker Offset or use [Marker Ref] to reset the Marker Offset in the new units.

Pressing [Marker Ref] changes from Off to Rel. and sets the Marker Offset to the current Marker Position. [Marker Ref] again changes from Rel. back to Off.

4-42 Normal Marker Menu

Each display has its own Normal Marker X Offset. This entry field can be linked to both displays using the [Link] key.

Command: MROX (?) d {, x}

Y-Rel

Set the Y Offset for the Normal Marker of the active display. Enter a new offset numerically or adjust it with the knob.

When the Marker Rel Mode is Relative, the marker position is calculated relative to the Marker Offset (X-Rel, Y-Rel). The Marker Offset location (if it is within the display) is marked by a small flag shaped symbol.

The Marker Offset has no associated units. The relative calculation simply subtracts the Marker Offset (in the display units) from the absolute marker position. Changing the display units invalidates the Marker Offset. Re-enter the Marker Offset or use [Marker Ref] to reset the Marker Offset in the new units.

Pressing [Marker Ref] changes from Off to Rel. and sets the Marker Offset to the current Marker Position. [Marker Ref] again changes from Rel. back to Off.

Each display has its own Normal Marker Y Offset. This entry field can be linked to both displays using the [Link] key.

Command: MROY (?) d {, x}

X-Rel

Set the X Rel Mode for the Normal Marker of the active display [Off, On].

When the Marker Rel Mode is Relative to the Marker Offset or Relative to the Other Display, the marker Y value is shown relative to the offset or other display.

Choose On to show the marker X value relative to the offset or other display as well.

Choose Off to show the absolute marker X value. This is useful when making relative amplitude measurements while still needing to read the marker X position in absolute units.

Each display has its own X Rel Mode. This entry field can be linked to both displays using the [Link] key.

Command: MXRL (?) d {, i}

Harmonic Marker Menu

This menu is displayed when the active display Marker Mode is Harmonic.

Marker Setup	
Marker	On
Mode	Harmonic
# Harmonics	3
Display	Fundamental
Readout Mode	Absolute
THD	0.00737 %
	-92.6 dB
RMS Harm. Power	18.44 μ Vrms

Harmonics

Set the Number Of Harmonics for the active display [1.. 100]. The second harmonic (2xfundamental) is identified as #1, etc.

The Harmonic Marker identifies the fundamental frequency with the Fundamental Marker (solid vertical line) and the number of harmonics with small triangular Harmonic Markers. The Marker Position Display can read the Fundamental or a single Harmonic.

Only those harmonics within the measurement span which are identified by the Harmonic Markers contribute to the THD calculations. The harmonic identification works best if the fundamental frequency is a bin frequency. If the fundamental is off-bin, then it is best to use the Flattop window to broaden all of the peaks.

Each display has its own Number Of Harmonics. This entry field can be linked to both displays using the [Link] key.

Command: HRMN (?) d {, i}

Display

Select the Harmonic and Sideband Display for the active display. The Marker Position can display the Fundamental or any identified Harmonic or Sideband.

For Harmonic Marker, the minimum is 0 (Fundamental) and the maximum is the Number Of Harmonics. The second harmonic (2xfundamental) is identified as #1, etc.

For Sideband Marker, the value ranges from 0 (Fundamental) to plus and minus the Number Of Sidebands. The first lower sideband is identified as #-1, the first upper sideband is #1, etc.

4-44 Harmonic Marker Menu

The small square marker will move to the selected harmonic or sideband. If the selection is not within the measurement span, the marker will move to the highest or lowest measured frequency (which will be reported as the Marker Position).

Each display has its own Harmonic and Sideband Display. This entry field can be linked to both displays using the [Link] key.

Command: HDSP (?) d {, i}

Readout Mode

Select the Readout Mode for the Harmonic and Sideband Marker of the active display [Absolute, Relative]. The Marker Position Display shows the amplitude of the Fundamental or any identified Harmonic or Sideband in either Absolute units or Relative to the fundamental.

Relative Mode reports the amplitude of the selected harmonic or sideband relative to the fundamental. The marker amplitude units are dBFundamental. The frequency is always absolute.

Each display has its own Readout Mode. This entry field can be linked to both displays using the [Link] key.

Command: HRDO (?) d {, i}

THD

This menu box displays the Total Harmonic Distortion (THD) of the active display. The THD squared is the harmonic power (sum of the squared magnitudes of the harmonics) divided by the sum of the fundamental power plus the harmonic power.

Only those harmonics within the measurement span which are identified by Harmonic Markers contribute to the THD.

The THD is displayed in dB ($20\log(\text{THD})$) and percent.

To measure THD+N, use the Band Marker.

Command: HTHD ? d , i

Harmonic Power

This menu box displays the Total Harmonic Power of the active display. The harmonic power is the sum of the squared magnitudes of the harmonics identified with a Harmonic Marker. The result is shown in Vrms. To convert to power, square this result.

Command: HPWR ? d

Sideband Marker Menu

This menu is displayed when the active display Marker Mode is Sideband.

Marker Setup	
Marker	On
Mode	Sideband
Sideband Sep.	4.096 kHz
# Sidebands	1
Display	Fundamental
Readout Mode	Absolute
Sideband Ratio	-98.3 dB
RMS SB Power	3.038 μ Vrms

Sideband Separation

Set the Sideband Separation for the active display.

The Sideband Marker identifies the carrier frequency with the Fundamental Marker (solid vertical line) and the number of sidebands with small triangular Sideband Markers. The Sideband Separation determines the location of these Sideband Markers relative to the Fundamental.

Only those sidebands within the measurement span which are identified by the Sideband Markers contribute to the Sideband Power calculations.

Each display has its own Sideband Separation. This entry field can be linked to both displays using the [Link] key.

Command: SSEP (?) d {, f}

Sidebands

Select the Number Of Sidebands for the active display [1..50]. The first upper sideband (fundamental+separation) is identified as #1, the first lower sideband (fundamental-separation) is #-1, etc.

The Sideband Marker identifies the carrier frequency with the Fundamental Marker (solid vertical line) and the number of sidebands with small triangular Sideband Markers. The Sideband Separation determines the location of these Sideband Markers relative to the fundamental.

Only those sidebands within the measurement span which are identified by the Sideband Markers contribute to the Sideband Power calculations. The sideband identification

4-46 Sideband Marker Menu

works best if the fundamental frequency is a bin frequency. If the fundamental is off-bin, then it is best to use the Flattop window to broaden all of the peaks.

Each display has its own Number Of Sidebands. This entry field can be linked to both displays using the [Link] key.

Command: SDBN (?) d {, i}

Display

Select the Harmonic and Sideband Display for the active display. The marker display can read the position of the fundamental or any identified harmonic or sideband.

For sideband marker, the value ranges from 0 (fundamental) to plus and minus the Number of Sidebands. The first lower sideband is identified as #-1, the first upper sideband is #1, etc.

The small square marker will move to the selected harmonic or sideband. If the selection is not within the measurement span, the marker will move to the highest or lowest measured frequency (which will be reported as the marker position).

Each display has its own harmonic/sideband display. This entry field can be linked to both displays using the [Link] key.

Command: HDSP (?) d {, i}

Readout Mode

Select the Readout Mode for the Harmonic and Sideband Marker of the active display [Absolute, Relative]. The Marker Position Display shows the amplitude of the Fundamental or any identified Harmonic or Sideband in either Absolute units or Relative to the fundamental.

Relative Mode reports the amplitude of the selected harmonic or sideband relative to the fundamental. The marker amplitude units are dBFundamental. The frequency is always absolute.

Each display has its own Readout Mode. This entry field can be linked to both displays using the [Link] key.

Command: HRDO (?) d {, i}

Sideband Ratio

This menu box displays the Sideband Ratio of the active display. The sideband power is the sum of the squared magnitudes of the sidebands. Only those sidebands within the measurement span which are identified by Sideband Markers contribute to the calculation.

The Sideband Ratio in dB is $10\log(\text{sideband power}/(\text{fundamental power}+\text{sideband power}))$.

Command: SPWR ? d , i

RMS Sideband Power

This menu box displays the Sideband Power of the active display. The Sideband Power is the sum of the squared magnitudes of the sidebands. Only those sidebands within the measurement span which are identified by Sideband Markers contribute to the calculation. The Sideband Power is displayed in Vrms. To convert to power, square this result.

Command: SPWR ? d , i

Band Marker Menu

This menu is displayed when the active display Marker Mode is Band.

Marker Setup	
Marker	On
Mode	Band
Modify Band	Upper ²
Band Exclude	none
Band Ratio Mode	² / ₁
Band Power	2.958 μ Vrms
	38.56 μ Vrms
Band Ratio	7.67 %
	-22.3 dB

Modify Band

Select the Upper (2) or Lower (1) Band Marker to modify. Use the knob to move the selected band. Use [Alt] knob to re-size the selected band.

The Marker Position display above the graph shows the left and right limits of the selected band and the Band Power. The Band Power is the sum of the squared magnitudes of all frequencies within the band (shown in Vrms). The label '1' or '2' preceding the Marker Position display denotes Lower or Upper Band Marker.

Command: BMKL (?) d, i {, j} or BMKR (?) d, i {, j}

Band Exclude

Select Band Exclusion for the Band Marker in the active display [none, 1from2, 2from1].

None means that the two bands are independent and include all bins within their left and right limits.

1from2 means the bins in band 1 (Lower) are excluded from the band 2 (Upper) power. The region where the two bands overlap is not included in band 2 (Upper).

2from1 means the bins in band 2 (Upper) are excluded from the band 1 (Lower) power. The region where the two bands overlap is not included in band 1 (Lower).

For example, to measure THD+N, use the Lower (1) band to define a small region around the fundamental and the Upper (2) band to define the total bandwidth of interest. Exclude '1from2' so the Upper (2) band does not measure the fundamental. Choose the 2/(1+2)

ratio mode to measure THD+N (power with fundamental notched out/total power including fundamental).

Command: BEXC (?) d {, i}

Band Ratio Mode

Select the Band Ratio Mode for the Band Marker in the active display [2/1, 2/(1+2)]. The calculated ratio is displayed in the <Band Ratio> menu box.

2/1 specifies that the Band Ratio is computed from the ratio of the Upper (2) band power to the Lower (1) band power.

2/(1+2) specifies that the Band Ratio is computed from the ratio of the Upper (2) band power to the sum of the Lower (1) and Upper (2) band powers.

For example, to measure THD+N, use the Lower (1) band to define a small region around the fundamental and the Upper (2) band to define the total bandwidth of interest. Exclude '1from2' so the Upper (2) band does not measure the fundamental. Choose the 2/(1+2) ratio mode to measure THD+N (power with fundamental notched out/total power including fundamental).

Command: BRAM (?) d {, i}

Band Power

This menu box displays the Upper (top) and Lower (bottom) Band Powers of the active display. The Band Power is the sum of the squared magnitudes of all bins within each Band Marker. The result is shown in Vrms. (Square this result for power.)

Command: BPWR (?) d, i

Band Ratio

This menu box displays the band ratio, either 2/1 or 2/(1+2) as selected by the Band Ratio Mode, for the active display. The result is shown in % and dB.

Command: BRAT (?) d, i

Source Menu

The Source menu selects and configures the source waveform. The Measurement Group determines the available source types. Choosing a source type selects the source waveform and displays the appropriate setup menu.



Watch Out For Triggered Sources

If a triggered source is selected (Chirp, Burst Chirp, Burst Noise or Arbitrary), the triggered measurement phase is stable only if the input signals are derived from the source output. Turn the source off (or set it to Sine) when making triggered measurements without the source.



Source Off

Turn off the source output. The output is held at 0 V.

If a triggered source is selected (Chirp, Burst Chirp, Burst Noise or Arbitrary), the phase of the measurement is relative to the source, not the trigger.

Command: SRCO (?) {i}

Source On

Turn on the source output. The output is determined by the selected source type.

Command: SRCO (?) {i}

Sine

Set the source output to Sine and display the Sine Setup menu.

The output is the sum of two tones (sine waves) plus the offset. To generate a single tone, set the amplitude of one of the tones to zero. The frequencies should be exact bin frequencies of the FFT. This eliminates windowing effects in the measured amplitude and phase.

The sine source is not triggered. The output is always continuous.

Command: STYP (?) {i}

Chirp

Set the source output to Chirp and display the Chirp Setup menu.

The output is an equal amplitude sine wave at each frequency bin of the FFT spectrum. This source is useful for measuring transfer functions quickly. Use Source Trigger for stable time records and phase. The Uniform window should be used since individual frequencies are not present at all times in the time record. The chirp is exactly periodic with the FFT time record so the Uniform window does not cause 'leakage' problems.

This source is only available for the FFT Measurement Group. The chirp frequency span and burst time record is linked to either DisplayA or DisplayB. If the other display has a different span, the chirp span will not be appropriate for that display.

The chirp source is triggered by External triggers. Set the Trigd Source Mode to trigger once or with every trigger. With Free Run Trigger Mode, the chirp repeats over and over.



Trigger Caution

If the Chirp source is selected, the triggered FFT measurement phase is stable only if the input signals are derived from the triggered source output. Turn the source off (or set it to Sine) when making triggered measurements of external signals (not the source).

Command: STYP (?) {i}

Noise

Set the source output to Noise and display the Noise Setup menu.

The output is broadband noise. This source is useful for estimating transfer functions quickly. White noise provides equal amplitude per $\sqrt{\text{Hz}}$. White noise is useful in electronic applications. Pink noise rolls off at 3 dB/oct providing equal energy per octave. Pink noise is preferred for octave analysis.

Burst noise is selected whenever the Burst percentage is less than 100%. The burst noise source is triggered by External triggers. Set the Trigd Source Mode to trigger once or with every trigger. With Free Run Trigger Mode, the burst repeats over and over.

In FFT group, the noise bandwidth and burst time record is linked to either DisplayA or DisplayB. If the other display has a different span, the source may not be appropriate for that display.

Since the signal is random, windows are always required when making FFT measurements using the noise source.

In Octave group, the burst period is not linked to a display but is specified in time. The bandwidth is always full bandwidth.

**Trigger Caution**

If the Noise source is selected and the Burst is less than 100%, the triggered FFT measurement phase is stable only if the input signals are derived from the triggered source output. Turn the source off (or set it to Sine) when making triggered measurements of external signals (not the source).

Command: STYP (?) {i}

Arbitrary

Set the source output to Arbitrary and display the Arbitrary Setup menu.

The Arbitrary source plays a waveform stored in memory. The waveform can be either Capture buffer or the Arbitrary Waveform memory. Use the <Memory Allocation> menu to allocate memory between the capture buffer, waterfall storage and the arbitrary source waveform. The Capture buffers may not be selected as the Arbitrary source if they do not contain data.

The Arbitrary waveform memory can be loaded via the computer interfaces, from a disk file or from a stored trace. The Capture buffer is filled by capturing an input signal.

The Arbitrary source can play a portion of memory starting at a specified point. The output sampling rate can also be specified. The amplitude of the source is set relative to 1 V (up to a maximum of 5 V).

Triggering

The Arbitrary source is triggered by External triggers. Set the Trig Source Mode to trigger once (1-Shot) or with every trigger (Continuous).

In the 1-Shot case, the source only triggers on the first trigger after [Start/Reset]. This same trigger starts the measurement (and waterfall). This is useful when the source length is very long compared to the measurement time. This allows a sequence of many measurements to be triggered at the start of a single playback of a long source.

In the Continuous case, the source triggers on every trigger, with a minimum trigger period set by the Arbitrary Source Length. This is useful when the source length is the same as the FFT time record length.

Source trigger outputs the source continuously over and over. The FFT time records are synchronized to the source start.

Free Run Trigger Mode outputs the source continuously over and over.

Do not use Ch1 or Ch2 input trigger since the output will not start until a trigger is received.

**Trigger Caution**

If the Arbitrary source is selected, the triggered FFT measurement phase is stable only if the input signals are derived from the triggered source output. Turn the source off (or set it to Sine) when making triggered measurements of external signals (not the source).

Command: STYP (?) {i}

Sine Source Menu

The Sine Source menu is used to set the frequency, offset, and amplitude of the sine source.

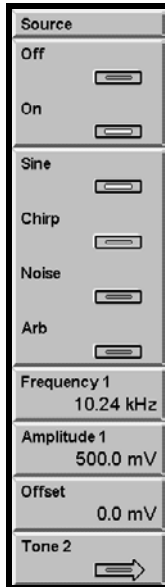

Frequency 1

Set the Frequency of Tone 1. The sine output is the sum of two tones (sine waves). When the knob is used to adjust the frequency, the resolution is equal to the Linewidth of the active display FFT Span. The knob always sets the frequency to an exact multiple of the Linewidth. For octave analysis, the Linewidth of the most recent FFT Spans are used (with an FFT Base of 100.0 kHz).

The keypad allows arbitrary frequencies to be entered. Remember, the output is periodic over the FFT time record only if the frequency is an exact multiple of the Linewidth. Source Trigger will not result in a stable phase for non-periodic frequencies.

The sine source is not triggered. The output is always continuous.

Command: S1FR (?) {f}

Amplitude 1

Set the peak Amplitude of Tone 1 [0..5V]. The amplitude resolution is 0.1 mV. The sine output is the sum of two tones (sine waves) and the offset (constant). To generate a single tone, set the amplitude of one of the tones to zero. Note that the sum of the amplitudes of Tone 1, Tone 2 and the absolute value of the offset cannot exceed 5 V.

Command: S1AM (?) {x}

Offset

Set the DC Offset of the Sine Source [-5V..5V]. The offset resolution is 0.1 mV. The sine output is the sum of two tones (sine waves) and the offset (constant). Note that the sum of the amplitudes of Tone 1, Tone 2 and the absolute value of the offset cannot exceed 5 V. Also, using large offsets with small tone amplitudes will degrade the distortion performance of the sine source.

Command: SOFF (?) {x}

Tone 2

Display the Tone 2 Settings menu. Press <Return> for the main [Source] menu.

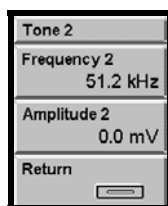

Frequency 2

Set the Frequency of Tone 2. The sine output is the sum of two tones (sine waves). When the knob is used to adjust the frequency, the resolution is equal to the Linewidth of the active display FFT Span. The knob always sets the frequency to an exact multiple of the Linewidth. For octave analysis, the Linewidth of the most recent FFT Spans are used (with an FFT Base of 100.0 kHz).

The keypad allows arbitrary frequencies to be entered. Remember, the output is periodic over the FFT time record only if the frequency is an exact multiple of the Linewidth. Source Trigger will not result in a stable phase for non-periodic frequencies.

The sine source is not triggered. The output is always continuous.

Command: S2FR (?) {f}

Amplitude 2

Set the Amplitude of Tone 2 [0..5V]. The amplitude resolution is 0.1 mV. The sine output is the sum of two tones (sine waves) and the DC offset (constant). To generate a single tone, set the amplitude of one of the tones to zero. Note that the sum of the amplitudes of Tone 1, Tone 2 and the absolute value of the offset cannot exceed 5 V.

Command: S2AM (?) {x}

Chirp Source Menu

The Chirp Source menu is used to configure the chirp source.

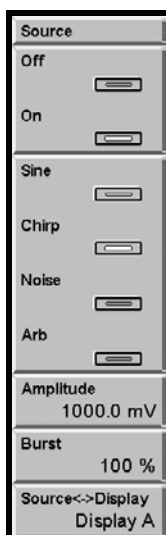

Amplitude

Set the peak Amplitude of the chirp. The peak output level is approximate due to the ripple in the source output reconstruction filter.

Changing the FFT Resolution changes the amplitudes of the individual frequency components relative to the peak. If the FFT Resolution is 400 lines, the amplitude of each frequency component is about -30 dB relative to the peak amplitude. If the individual frequency components were perfectly random, each component would be $1/\sqrt{400}$ (-26 dB) relative to the peak. However, the chirp waveform is identical from time record to time record and each component has a fixed phase relative to all the other components. This worsens the crest factor by a few dB and reduces the amplitude of each component for a specified peak amplitude. The input dynamic range of the measurement is reduced when using the chirp source.

Command: CAMP (?) {x}

Burst

Set the Burst Percentage of the chirp [0.1%..100%]. The chirp waveform is output over a percentage of the FFT time record of the display selected as the Source Display. Burst is only available for the FFT Measurement Group.

For a continuous output, use 100% burst with Free Run Trigger Mode or Source Trigger. Source Trigger will synchronize the FFT time record with the chirp waveform.

With External Trigger, the chirp waveform is triggered along with the FFT time record. Set the Trigd Source Mode to Continuous to trigger the source with every time record.

4-58 Chirp Source Menu

Do not use Ch1 or Ch2 input trigger since the output will not start until a trigger is received.

Command: CBUR (?) {x}

Source Display

Select the Source Display [DisplayA, DisplayB]. The Source Display only applies for the FFT Measurement Group.

The Source Display is the display which determines the burst period (FFT time record) and the bandwidth for bandlimited noise and chirp (FFT Span). There is a single Source Display for both Chirp and Noise outputs. Changing this entry for one type of source also changes it for the other.

Select which display sets the time record and frequency span of the chirp. If the other display has a different span, the chirp will not be appropriate for that span.

Burst Chirp is a percentage of the Source Display FFT time record length.

Command: CSRC (?) {i}

Noise Source Menu

The Noise Source menu is used to configure the noise source.

Source	
Off	<input type="checkbox"/>
On	<input type="checkbox"/>
Sine	
Chirp	<input type="checkbox"/>
Noise	<input type="checkbox"/>
Arb	<input type="checkbox"/>
Amplitude	
500.0 mV	
Type	
BL White	
Burst	
100 %	
Source->Display Display A	
Source Period	
100 ms	

Amplitude

Set the peak Amplitude of the noise output. The source output will overshoot this amplitude by as much as 100% a small percentage of the time. Because of the nature of noise, the peak amplitude is not perfectly defined.

Command: NAMP (?) {x}

Type

Select the Type of noise output. [White, Pink, Bandlimited White or Pink].

White Noise

White noise provides equal noise density ($V/\sqrt{\text{Hz}}$) from 0 to above 102.4 kHz (regardless of the measurement bandwidth of the displays). The spectrum of white noise appears flat in an FFT spectrum. The power spectral density (PSD) remains constant at all spans.

Pink Noise

Pink noise rolls off at 3 dB/oct providing equal energy per octave and extends beyond 102 kHz. The spectrum of pink noise appears flat in octave analysis.

BandLimited White

Bandlimiting restricts the noise bandwidth to the measurement span of the Source Display. Bandlimited noise is available only for the FFT Measurement Group.

Command: NTYP (?) {i}

Burst

Set the Burst Percentage of the noise [0.1%..100%].

In FFT group, the noise waveform is output for a percentage of the FFT time record of the display selected as the Source Display.

In Octave group, the burst period is not linked to a display but is specified in time by the Source Period.

For a continuous output, use 100% burst.

Triggering

When the burst percentage is less than 100%, the burst noise source is triggered by External triggers. Set the Trig Source Mode to trigger once (1-Shot) or with every trigger (Continuous). In the 1-Shot case, the burst source only triggers on the first trigger after [Start/Reset]. This same trigger starts the measurement (and waterfall). In the Continuous case, the source triggers on every trigger, with a minimum trigger period set by the time record of the Source Display (FFT) or the Source Period (Octave).

Source trigger outputs a noise burst every source period or FFT time record. The FFT time records are synchronized to the burst.

Free Run Trigger Mode outputs a noise burst every source period.

Do not use Ch1 or Ch2 input trigger since the output will not start until a trigger is received.

Command: NBUR (?) {x}

Source Display

Select the Source Display [DisplayA, DisplayB]. The Source Display only applies for the FFT Measurement Group. The Source Display is the display which determines the burst time record (FFT time record) and the bandwidth for bandlimited noise and chirp (FFT Span). There is a single Source Display for both Chirp and Noise outputs. Changing this entry for one type of source also changes it for the other.

Select which display sets the bandwidth for bandlimited noise. Burst Noise is a percentage of the Source Display FFT time record length.

The noise output is continuous for Octave Analysis.

Command: CSRC (?) {i}

Source Period

Set the Burst Period for noise in Octave group [4 ms..1ks].

In Octave group, the burst period is not linked to a display but is specified in time by the Source Period. The burst output is present for a Burst percentage of the Source Period.

Triggering

When the burst percentage is less than 100%, the burst noise source is triggered by External triggers. Set the Trigd Source Mode to trigger once (1-Shot) or with every trigger (Continuous). In the 1-Shot case, the burst source only triggers on the first trigger after [Start/Reset]. This same trigger starts the measurement (and waterfall). In the Continuous case, the source triggers on every trigger, with a minimum trigger period set by the Source Period.

Source trigger outputs a noise burst every source period.

Free Run Trigger Mode outputs a noise burst every source period.

Do not use Ch1 or Ch2 input trigger since the output will not start until a trigger is received.

Command: NPER (?) {x}

Arbitrary Source Menu

The Arbitrary Source menu is used to configure the arbitrary source.



Amplitude

Set the Amplitude of the arbitrary source relative to 1V [0%..500%]. The maximum output is 5V.

If the Arbitrary Waveform has been copied from a Trace, the data is normalized so that the point with the largest absolute value is output at $\pm 1V$ when the Amplitude is 100%.

When the Arbitrary Waveform is loaded from the computer interface, the data ranges from -1.0 to +1.0. A value of 1.0 is output at 1V when the Amplitude is 100%.

When playback is from a Capture buffer, the input range corresponds to full scale. For example, if a 0.1 Vpk (-20 dBV) signal is captured on an Input Range of -20 dBV (full scale at the input), it will play back at 1V when the Amplitude is 100%. To duplicate the actual signal amplitude, set the Amplitude to 10%.

Command: AAMP (?) {i}

Source Play Rate

Select the Arbitrary Source Play Rate. The Play Rate can be 1, 1/2, 1/4, 1/8, ... times the maximum sampling rate. The maximum sampling rate is 262.1 kHz when the FFT Base Frequency is 102.4 kHz and 256 kHz when the FFT Base Frequency is 100.0 kHz OR the Measurement Group is Octave.

When the Arbitrary source is a Capture buffer, the Play Rate defaults to the capture Sampling Rate. The Play Rate should be equal to the capture Sampling Rate to preserve the frequency content of the buffer.

When the Arbitrary source is the Arbitrary waveform memory, the Play Rate should be set according to the rate used to calculate the waveform samples.

When the Arbitrary source is copied from a time record trace, the Play Rate should be set to the sampling rate at which the time record was acquired.

Caution

In both cases, if the Play Rate is LESS than the maximum sampling rate, the output will contain alias frequency components above 1/2 the sampling rate. In general, the frequency span of any measurement using this source should not exceed 1/2 times the Play Rate to avoid measuring these alias frequencies.

Command: ARAT (?) {i}

Source

Select Arbitrary waveform playback from the Arbitrary Waveform memory or from a Capture buffer. Use the <Memory Allocation> menu to allocate memory between the capture buffer, waterfall storage and the arbitrary source waveform.

The Arbitrary waveform memory can be loaded from a stored trace, via the computer interfaces or from a disk file. The Capture buffer is filled by capturing an input signal.

Command: ASRC (?) {i}

More

Display the Arbitrary Source Settings menu. Press <Return> for the main [Source] menu.



Arb. Source Start

Select the Arbitrary Source Start position within the selected source buffer (either Arbitrary Waveform memory or Capture buffer). The start position is specified as a bin number or individual point position. During Arbitrary playback, the points are separated by a time equal to 1/Play Rate. The corresponding start time relative to the start of source buffer is displayed as well.

Command: ASTR (?) {i}

Arb. Source Length

Select the \Arbitrary Source Length in 2 kPoint (2048 points) increments. The Arbitrary Source Length (in points) plus the Arbitrary Source Start cannot exceed the length of the Arbitrary source buffer, either the Arbitrary waveform memory or the Capture Length. The corresponding source time length is displayed as well.

Command: ALEN (?) {i}

Set Left Edge

The Arbitrary Source playback must be from a Capture Buffer and the Measurement of the active display must be the Capture Buffer for this key to be active.

Choose the correct Capture Buffer as the Measurement and use Zoom and Pan to show the region of interest. Press <Set Left Edge> to set the Arbitrary Source Start to the marker position. The Arbitrary Source Length is not changed.

If the requested Source Start plus the Source Length (in points) exceeds the Capture Length of the buffer, the Source Length is reduced.

Set Right Edge

The Arbitrary Source playback must be from a Capture Buffer and the Measurement of the active display must be the Capture Buffer for this key to be active.

Choose the correct Capture Buffer as the Measurement and use Zoom and Pan to show the region of interest. Press <Set Right Edge> to set the Arbitrary Source Length to the marker position minus the Source Start. The Source Start is not changed.

The Source Length is always set to a 2 kPoint (2048 points) increment.

If the marker position is to the left of the Source Start, then the Source Length is set to the minimum (2 kPts).

Allocate Memory

Display the Memory Allocation menu.

Total Available

Displays the total memory available for storage, either 992, 2016 or 4066 blocks, depending upon the amount of installed memory. Each block is 2 kPoints (2048 points).

The total of the Capture, Waterfall and Arbitrary memory allocations cannot exceed the Total Available memory. It may be necessary to decrease one allocation in order to increase another.

Command: MMEM ?

Capture Memory

Allocates memory blocks for the capture buffer. The allocated Capture Memory sets the limit for the Capture Length. Capture memory must be allocated before the capture buffer may be used.

Waterfall Memory

Allocates memory blocks for waterfall storage. Waterfall memory must be allocated before waterfall displays may be used.

Arb. Memory

Allocates memory blocks for the Arbitrary Source waveform. The Arbitrary Source can also use the capture buffer as the output waveform.

Clear Allocation

Clears the existing memory allocations in this menu.

Confirm Allocation

Places the memory allocations in this menu into effect. Exiting this menu without pressing <Confirm Allocation> will cancel any adjustments made in this menu.

Command: MALC i, j, k

Trace to Arb

Copy the real part of a stored trace into the Arbitrary Waveform memory. Select a Trace [1..5] and press [Enter]. The Arb Length is set to 2 kpoints and the Arbitrary Waveform Source is set to the Arbitrary Buffer.

Only traces which contain FFT measurements can be copied to the Arbitrary memory. In almost all cases, the trace should contain a time record.

If the length of the trace is less than 2 kPoints (2048 points), then the trace is repeated until 2 kPoints is reached. This can cause discontinuities if the trace is not continuous from its end to its beginning. If this source is measured with an FFT time record equal to the trace length (in time), then windowing should solve this problem.

4-66 Arbitrary Source Menu

Only the real part of the trace is used. Baseband time records are completely real and can be reproduced as an Arbitrary waveform. Non-baseband time records or complex traces do not reproduce well.

The amplitude of the Arbitrary Waveform is normalized to the maximum value in the Trace. The largest trace value is considered full scale (100% amplitude = 1V).

Be sure to set the Play Rate to the appropriate value to reproduce the frequencies in the trace correctly.

Command: TARB i

Swept Sine Source Menu

The Source menu sets the source amplitude parameters when the Measurement Group is Swept Sine. See ‘Swept Sine’ in Chapter 2 for a discussion about swept sine measurement fundamentals.

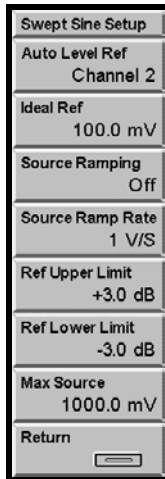

Auto Level Reference

Select the Auto Level Reference mode [Off, Channel 1, Channel 2].

Auto Level Off maintains the source amplitude at a constant level at all frequencies during the swept sine sweep. This usually works best for transfer functions which are fairly flat.

Auto Level Channel 1 or 2 will adjust the source level to maintain a constant level, called the Ideal Reference, at the Channel 1 or Channel 2 input. Generally, this is useful for transfer functions with substantial gain as well as attenuation. Input Auto Ranging is turned on for both inputs when Auto Level is on. Whenever Auto Level is used, the measurement MUST be transfer function.

The Auto Level Reference Channel determines which input will be maintained at the Ideal Reference Level. This is usually the device under test output (Channel 2). In some cases where the device under test is not driven directly from the source output, the device input (Channel 1) may be the reference.

Command: SSAL (?) {i}

Amplitude

Set the sine Amplitude [0 mV .. 5000 mV]. This parameter is adjustable only if Auto Level Reference is Off.

The swept sine source turns off whenever there are no measurements being made. This is before the sweep is started, at the end of a single sweep or while a sweep is paused. If

4-68 Swept Sine Source Menu

Source Ramping is Off, the source shuts off instantly in these situations. If Source Ramping is On, the source will ramp off. When the sweep is started or re-started, the source will ramp on for the first measurement.

The amplitude may be changed at any time during a sweep.

Command: SSAM (?) {x}

Ideal Reference

Set the Ideal Reference [0 mV .. 5000 mV]. This parameter is adjustable only if Auto Level Reference is set to Channel 1 or Channel 2.

The Ideal Reference is the signal level that the source maintains at the Reference Channel to within the Reference Limits. This is determined by the limitations of the device under test or may simply be the desired signal level for the test. If the Ideal Reference requires a source amplitude greater than the Maximum Source Level, then the Reference Channel signal will fall below the Ideal Reference. In cases where the required source amplitude is very small, the resolution of the source amplitude may result in a Reference Channel signal which is not within tolerance of the Ideal Reference.

The Ideal Reference may be changed at any time during a sweep.

Command: SSRF (?) {x}

Source Ramping

Select the Source Ramping Mode [Off, On].

If Source Ramping is Off, source level changes are made instantly.

If Source Ramping is On, source level changes are made at the Source Ramp Rate. Settling starts after the source amplitude reaches the desired level. This prevents fast level changes from disturbing the device under test.

The swept sine source turns off whenever there are no measurements being made. This is before the sweep is started, at the end of a single sweep or while a sweep is paused. If Source Ramping is Off, the source shuts off instantly in these situations. If Source Ramping is On, the source will ramp off. When the sweep is started or re-started, the source will ramp on for the first measurement.

Command: SRMP (?) {i}

Source Ramp Rate

Set the Source Ramp Rate [0.001 V/s .. 500 V/s].

The Source Ramp Rate is the rate at which the source amplitude changes when Source Ramping is On. If Source Ramping is Off, source amplitude changes are made instantly.

Note that very slow ramp rates can add significantly to the sweep time, especially if Auto Level is on and many changes to the source amplitude are required during the sweep. Also, the source ramps up when the sweep is started and ramps off when paused. This causes a delay before the first point is measured.

Command: SRAT (?) {x}

Reference Upper Limit

Set the Reference Upper Limit [0.1 dB .. 30.0 dB]. This parameter is adjustable only if Auto Level Reference is set to Channel 1 or Channel 2.

When Auto Level is on, the Ideal Reference is the signal level the source will try to maintain at the Reference Channel. The Reference Upper and Lower Limits are the allowable tolerances for the Reference Channel. The source level is changed only if the reference channel measures an input which exceeds the Ideal Reference by more than the Upper Limit or which is less than the Ideal Reference by more than the Lower Limit. In cases where the reference channel input must be limited, the Ideal Reference plus the Upper Limit must be less than or equal to this limit. If the required source amplitude is very small, the resolution of the source amplitude may result in a Reference Channel signal which is not within tolerance of the Ideal Reference.

The Reference Upper Limit may be changed during a sweep.

Command: SSUL (?) {x} or SSLL (?) {x}

Reference Lower Limit

Set the Reference Lower Limit [-0.1 dB .. -30.0 dB]. This parameter is adjustable only if Auto Level Reference is set to Channel 1 or Channel 2.

When Auto Level is on, the Ideal Reference is the signal level the source will try to maintain at the Reference Channel. The Reference Upper and Lower Limits are the allowable tolerances for the Reference Channel. The source level is changed only if the reference channel measures an input which exceeds the Ideal Reference by more than the Upper Limit or which is less than the Ideal Reference by more than the Lower Limit. If a source amplitude greater than the Maximum Source Level is required, then the Reference Channel signal may fall below the Reference Lower Limit.

The Reference Lower Limit may be changed during a sweep.

Command: SSLL (?) {x}

Maximum Source Level

Set the Maximum Source Level [0 mV .. 5000 mV]. This parameter is adjustable only if Auto Level Reference is set to Channel 1 or Channel 2.

4-70 Swept Sine Source Menu

The Maximum Source Level is the largest allowed source amplitude. This is limited by the SR780 source output or the device under test input range. If the Reference Lower Limit requires a source amplitude greater than the Maximum Source Level, then the source amplitude is set to the Maximum Source Level. In this case, the Reference Channel may fall below the Reference Lower Limit.

The Maximum Source Level may be changed at any time during a sweep.

Command: SMAX (?) {x}

Input Menu

Depending upon the Input Source, the Input menu either configures the inputs and sets the input ranges or sets the parameters for capture playback.

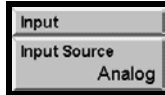

Input Source

Select the measurement Input Source [Analog, Playback].

Analog uses the Ch1 and Ch2 front panel inputs as the source for all measurements. This menu adjusts the input configurations for both inputs.

Playback uses the data stored in the capture buffer as the input for all measurements. This selection is not valid until capture data has been acquired. This menu sets the playback parameters. Capture is not available for swept sine measurements.

Both displays use the same Input Source for their measurements. The Analog/Playback indicator shows the input source at the top of the screen.

Command: ISRC (?) {i}

Analog Input Menu

When the Input Source is Analog, this menu configures the two front panel inputs.

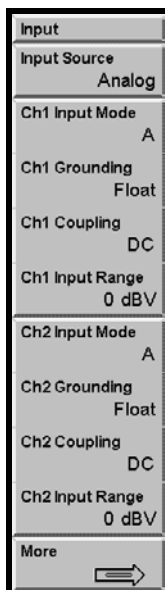

Ch1 Input Mode

Select the Input Mode for the Ch1 input [A (single-ended), A-B (differential)]. The Input indicator shows the current mode at the top of the screen.

In general, when looking at very small signals, connect A to the signal source and B to the signal ground and use A-B. In this case, make sure that the two input cables do not encompass any loop area (twist them together or run them side by side).

Command: I1MD (?) {i}

Ch1 Grounding

Select the Input Grounding for the Ch1 input shields [Float, Ground].

The shields of A and B are connected.

Float connects the shields to chassis ground through $1\text{ M}\Omega + 0.01\text{ }\mu\text{F}$. This allows the shield of a single ended input to ‘float’.

Ground connects the shields to chassis ground with $50\text{ }\Omega$. In this mode, do not exceed 3 V on the shields.

The impedance between signal input and chassis ground is always $1\text{ M}\Omega$.

Command: I1GD (?) {i}

Ch1 Coupling

Select the Input Coupling for the Ch1 input [DC, AC, ICP]. The Input indicator shows the current coupling at the top of the screen.

The 3 dB bandwidth of the AC coupling is 0.16 Hz.

ICP coupling connects a 5 mA current source (26 VDC open circuit) to the center conductor of the A input connector. This supply powers ICP accelerometers. The signal is AC coupled from the center conductor. Set the Input Mode to A (not A-B).

Command: I1CP (?) {i}

Ch1 Input Range

Select the Input Range for the Ch1 input [-50 dBV .. +34 dBV]. The Input Range is the full scale signal input just before overload. The Input Range varies by 2 dB steps. The Input Range indicator shows the current range at the top of the screen.

Pressing this softkey turns off Ch1 Auto Range.

If the Ch1 input signal exceeds 35 dBV, the input range is automatically set to 34 dBV. The range may not be changed while this HighV condition exists.

Command: I1RG (?) {i}

Ch2 Input Mode

Select the Input Mode for the Ch2 input [A (single-ended), A-B (differential)]. The Input indicator shows the current mode at the top of the screen.

In general, when looking at very small signals, connect A to the signal source and B to the signal ground and use A-B. In this case, make sure that the two input cables do not encompass any loop area (twist them together or run them side by side).

If the Ch2 input signal exceeds 35 dBV, the input range is automatically set to 34 dBV. The range may not be changed while this HighV condition exists.

Command: I2MD (?) {i}

Ch2 Grounding

Select the Input Grounding for the Ch2 input shields [Float, Ground].

The shields of A and B are connected.

Float connects the shields to chassis ground through $1\text{ M}\Omega + 0.01\text{ }\mu\text{F}$. This allows the shield of a single ended input to 'float'.

Ground connects the shields to chassis ground with $50\text{ }\Omega$. In this mode, do not exceed 3 V on the shields.

The impedance between signal input and chassis ground is always $1\text{ M}\Omega$.

Command: I2GD (?) {i}

Ch2 Coupling

Select the Input Coupling for the Ch2 input [DC, AC, ICP]. The Input indicator shows the current coupling at the top of the screen.

The 3 dB bandwidth of the AC coupling is 0.16 Hz.

ICP coupling connects a 5 mA current source (26 VDC open circuit) to the center conductor of the A input connector. This supply powers ICP accelerometers. The signal is AC coupled from the center conductor. Set the Input Mode to A (not A-B).

Command: I2CP (?) {i}

Ch2 Input Range

Select the Input Range for the Ch2 input [-50 dBV .. +34 dBV]. The Input Range is the full scale signal input just before overload. The Input Range varies by 2 dB steps. The Input Range indicator shows the current range at the top of the screen.

Pressing this softkey turns off Ch2 Auto Range.

Command: I2RG (?) {i}

More

Display the More Input menu. Press <Return> or [Input] for the main Input] menu.

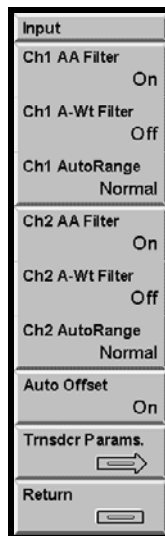
**Ch1 AA Filter**

Select the Anti-Aliasing Filter for the Ch1 input [Off, On].

The anti-aliasing filter should generally be left On. Frequency domain measurements may have spurious alias signals if the filter is Off.

For time domain measurements involving square waves or impulses, removing the filter can remove ringing and improve the accuracy of the time record.

The specifications apply only if the filter is On.

Command: I1AF (?) {i}

Ch1 A-Wt Filter

Select the A-Weighting Filter for the Ch1 input [Off, On]. The AWt indicator at the top of the screen shows 'AWt' in bright whenever the A-Weighting filter is On.

The A-Weighting filter simulates the hearing response of the human ear and is often used with Octave Analysis measurements. The input A-Weighting filter conforms to ANSI standard S1.4-1983.

A-, B- and C- Weighting functions are also available as operators in User Math functions.

Command: I1AW (?) {i}

Ch1 AutoRange

Select the AutoRange Mode for the Ch1 input [Normal, Tracking]. This mode only applies when Ch1 Auto Range is On.

In Normal Mode, only overload causes the Input Range to change. The Input Range only moves up.

In Tracking Mode, the Input Range moves up for overloads and down when the signal falls below half scale. Some signals, such as low frequency noise, can cause the Input Range to oscillate. Do not use Tracking Mode in these cases.

Auto Range responds to all frequencies present at the input (except those attenuated by AC coupling or the anti-aliasing filter), not just those within the measurement span.

Command: I1AR (?) {i}

Ch2 AA Filter

Selects the Anti-Aliasing Filter for the Ch2 input [Off, On].

The anti-aliasing filter should generally be left On. Frequency domain measurements may have spurious alias signals if the filter is Off.

For time domain measurements involving square waves or impulses, removing the filter can remove ringing and improve the accuracy of the time record.

The specifications apply only if the filter is On.

Command: I2AF (?) {i}

Ch2 A-Wt Filter

Select the A-Weighting Filter for the Ch2 input [Off, On]. The AWt indicator at the top of the screen shows 'AWt' in bright whenever the A-Weighting filter is On.

The A-Weighting filter simulates the hearing response of the human ear and is often used with Octave Analysis measurements. The input A-Weighting filter conforms to ANSI standard S1.4-1983.

A-, B- and C- Weighting functions are also available as operators in User Math functions.

Command: I2AW (?) {i}

Ch2 AutoRange

Select the AutoRange Mode for the Ch2 input [Normal, Tracking]. This mode only applies when Ch2 Auto Range is on.

In Normal Mode, only overload causes the Input Range to change. The Input Range only moves up.

In Tracking Mode, the Input Range moves up for overloads and down when the signal falls below half scale. Some signals, such as low frequency noise, can cause the Input Range to oscillate. Do not use Tracking Mode in these cases.

Auto Range responds to all frequencies present at the input (except those attenuated by AC coupling or the anti-aliasing filter), not just those within the measurement span.

Command: I2AR (?) {i}

Auto Offset

Enable Auto Offset input calibration [Off, On].

When Auto Offset is On, the analyzer will periodically perform an input offset calibration. This involves internally grounding both inputs and correcting their DC offsets. This only takes a second. However, the measurements will need to settle again after an offset calibration. To avoid disrupting a lengthy measurement, turn Auto Offset Off.

A warning message is displayed 15 seconds before an Auto Offset calibration is performed. Pressing [<-] (backspace) will abort the scheduled calibration.

Command: IAOM (?) {i}

Transducer Parameters

Display the Transducer Parameters menu. Press <Return> or [Input] for the main [Input] menu.

Transducers (such as accelerometers or microphones) convert a physical quantity (such as acceleration or pressure) into a voltage at the analyzer's input. By assigning Transducer Units to an input, measurements based upon the transducer signal may be displayed in units of the actual physical quantity being measured (such as m/s^2 or Pascals).

Transducer Units require a transducer which is linear over the frequency range of interest.

Measurements of inputs which are assigned units of acceleration, velocity or displacement may be displayed with any of these three units using Transducer Convert in the [Display Options] menu.

The image shows a menu titled "Transducer Units" with two sections for Channel 1 and Channel 2. Channel 1 settings are: Ch1 Eng. Units (On), Ch1 EU Label (m/s^2), Ch1 EU / Volt (1 EU/V), Ch1 EUs at Marker (a horizontal bar), and Ch1 User Label (EU). Channel 2 settings are: Ch2 Eng. Units (On), Ch2 EU Label (m/s^2), Ch2 EU / Volt (1 EU/V), Ch2 EUs at Marker (a horizontal bar), and Ch2 User Label (EU).

Engineering Units

Select Engineering Units for the Ch1 or Ch2 input [On, Off].

Measurements which require input data from a single input which has Engineering Units On will be displayed with units of EU Labels instead of Volts. The EU/Volt scaling is displayed along the vertical axis.

Measurements which require data from both input channels must have Engineering Units set the same for both inputs. Turning Engineering Units On or Off for one input channel automatically forces the other channel to follow. In this case, if Engineering Units are On, the EU/Volt scaling of both inputs is displayed along the vertical axis (Ch1 above Ch2).

The two displays have their own Engineering Units mode. This entry field can be linked to both displays using the [Link] key.

Command: EU1M (?) {i} or EU2M (?) {i}

EU Label

Choose the Engineering Units Label for the Ch1 or Ch2 input. The displayed units change from Volts to the EU Label when Engineering Units are On. Choose USER for the user defined User Label.

Input units of acceleration (m/s^2 or in/s^2), velocity (m/s or in/s), and displacement (m or in) may be converted within a frequency domain display using Transducer Convert in the [Display Options] menu. For example, the FFT of an input configured for an accelerometer with Engineering Units of m/s^2 may be displayed in displacement (meters) using Transducer Convert.

The two displays have their own EU Label. This entry field can be linked to both displays using the [Link] key.

Command: EU1L (?) {i} or EU2L (?) {i}

EU / Volt

Set the Engineering Units per Volt scale factor for the Ch1 or Ch2 input. This factor is used to scale the display units from Volts to Engineering Units when Engineering Units are On. The displayed units change from Volts to the EU Label.

The EU scale factor may be entered in EU/V, V/EU, or dB(EU/V). In all cases, the EU scale factor is displayed in EU/V along the vertical axis whenever a measurement takes its input from an input with Engineering Units On.

The two displays have their own EU scale factor. This entry field can be linked to both displays using the [Link] key.

Command: EU1V (?) {x} or EU2V (?) {x}

EUs at Marker

Calculate the EU/Volt scale factor for either the Ch1 or Ch2 input based upon the marker reading in the active display. Enter the desired calibrated value for the marker reading (in the display units).

The active display measurement must be a single channel measurement (FFT, Time, Octave, Swept Sine Spectrum) and Engineering Units must On.

This feature is normally used for the input channel which is being measured in the active display. In this case, the active display marker reading changes to the calibrated value. However, you can use this feature for the other input channel. In this case, the active display is not affected but other measurements based upon the other input are affected.

User Label

Enter the User Label for the Ch1 or Ch2 input Engineering Units. Use the [ALT] keys (for alphabetic entry) to enter a user defined name for the engineering units. The displayed units change from Volts to the User Label when Engineering Units are On and USER is chosen for the EU Label.

The two displays have their own User Label. This entry field can be linked to both displays using the [Link] key.

Command: EU1U (?) {s} or EU2U (?) {s}

Playback Input Menu

When the Input Source is Playback, this menu sets the playback parameters. The capture buffer must contain data and the Input Source must be set to Playback to display this menu.

Input
Input Source Playback
Playback Start 0 bins 0 s
Playback Length 500 kPts/ch 1.95 s
Set Left Edge <input type="text"/>
Set Right Edge <input type="text"/>
Playback Mode Circular
Playback Speed Normal

Playback Start

Select the Capture Playback Start position within the capture buffer. The start position is specified as a bin number or individual point position. The bins are separated by a time equal to $1/\text{Capture Sampling Rate}$. The corresponding start time relative to the start of the buffer is displayed as well.

Both channels playback starting at the Playback Start.

Command: ISTR (?) {i}

Playback Length

Select the Capture Playback Length in 2 kPoint (2048 points) increments. The Playback Length (in points) plus the Playback Start cannot exceed the Capture Length of the buffer. The corresponding playback time is displayed as well.

Both channels playback the same Playback Length.

Command: ILEN (?) {i}

Set Left Edge

The active display must be a Capture Buffer measurement for this key to be active.

4-82 Playback Input Menu

Choose a Capture Buffer as the Measurement and use Zoom and Pan to show the region of interest. Press <Set Left Edge> to set the Capture Playback Start to the marker position. The Playback Length is not changed.

If the requested Start position plus the Playback Length (in points) exceeds the Capture Length of the buffer, the Playback Length is reduced.

Set Right Edge

The active display must be a Capture Buffer measurement for this key to be active.

Choose a Capture Buffer as the Measurement and use Zoom and Pan to show the region of interest. Press <Set Right Edge> to set the Capture Playback Length to the marker position minus the Playback Start. The Playback Start is not changed.

If the marker position is to the left of the Playback Start, then the Playback Length is set to the minimum (2 kPts).

Playback Mode

Select the Capture Playback Mode [1-Shot, Circular].

In 1-Shot playback, the buffer is played a single time. The playback halts when the end of the buffer is reached.

In Circular playback, the playback starts over when the end of the buffer is reached. There is often a discontinuity in the playback measurement when the playback jumps from the end to the start of the buffer.

In either mode, press [Start/Reset] to restart playback at the start again.

The Capture Progress indicator at the top of the screen shows the playback progress through the buffer.

Both channels playback with the same Playback Mode.

Command: IMOD (?) {i}

Playback Speed

Select the Capture Playback Speed [Normal, Every Time Record].

Normal Playback Speed plays back the capture buffer in real time, i.e. 1 second of capture takes 1 second to playback. Normal Speed playback looks like the 'live' real time measurement. Normal playback is limited to the real time limitations of the equivalent real time analog input measurement.

Not all time records are displayed during Normal playback though all time records contribute to averaged measurements. For example, 1 second of capture contains 256 full

span FFT time records. Normal Speed playback at full span takes 1 second and updates the display only about 8 times during playback.

Every Time Record playback displays the measurement result for every captured time record. Since the data is stored in memory, Every Time Record playback is not limited by real time considerations. For example, 1 second of capture contains 256 full span FFT time records. In this case, all 256 time records are measured AND displayed. The display still updates at 8 Hz so playback takes about 32 seconds to complete. If the time records are overlapped, there may be more than 256 measurements to display and playback will take even longer.

When the measurement time records are very long (narrow spans), the time to process and display each measurement is much less than the real time record length. Since the data is already available in the capture buffer, Normal Speed playback means waiting unnecessarily for a real time record to elapse between updates. In this case, Every Time Record playback displays the measurements of all captured time records much faster than Normal Speed real time playback.

When the playback is in Octave Group, playback is always Normal Speed.

The Capture Progress indicator at the top of the screen shows the playback progress through the buffer.

Both channels playback with the same Playback Speed.

Command: ISPD (?) {i}

Trigger Menu

The Trigger menu configures the Trigger Mode, Source, Level and Delay.



Watch Out For Triggered Sources

If a triggered source is selected (Chirp, Burst Chirp, Burst Noise or Arbitrary), the triggered FFT measurement phase is stable only if the input signals are derived from the source output. Turn the source off (or set it to Sine) when making triggered measurements without the source.

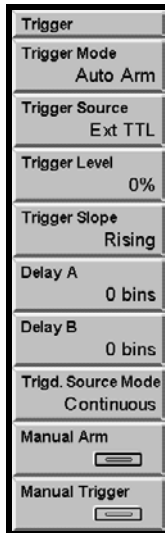

Trigger Mode

Select the Trigger Mode [Free Run, Auto Arm, Manual Arm].

Free Run lets the measurements without a trigger. Measurements begin with [Start/Reset] and run continuously or until they are complete.

Auto Arm enables triggering whenever measurements are running (with [Start/Reset]). For FFT measurements, auto arming means that as soon as both time records are processed, the trigger is immediately re-armed. Time records are taken as fast as the trigger delay and time record processing permit. Two FFT measurements are always triggered together.

Manual Arm enables triggering after [Start/Reset] only after the trigger is armed using <Manual Arm> or from an interface command. Once the trigger is armed, the next trigger event will trigger the measurement. For FFT measurements, each time record requires the trigger to be re-armed.

Triggers are ignored unless measurements are started (with [Start/Reset]) and the trigger is armed. Triggers are ignored while paused.

For octave and swept sine measurements, the first trigger after arming starts the measurement and subsequent triggers are ignored. Use [Start/Reset] to reset the measurement and start again.

The Trigger Mode governs the triggering of the measurement on both displays.

Command: TMOD (?) {i}

Trigger Source

Select the Trigger Source [Ch1, Ch2, External, Ext TTL, Source, Manual]. The Trigger Source does not apply if the Trigger Mode is Free Run.

Ch1 or Ch2 internally trigger on the Ch1 or Ch2 input signal. The trigger is detected after the anti-aliasing filter (if On).

External and Ext TTL trigger on the front panel Trigger Input. External has a variable Trigger Level and Ext TTL triggers on TTL signals.

Manual triggers with <Manual Trigger> or an interface command. Use Auto Arm Trigger Mode with Manual Trigger since unwanted triggers are not a problem.

External, Ext TTL and Manual also trigger the burst Chirp and Noise source waveforms.

Source triggers synchronously with the source waveform. The source runs continuously and Source Trigger synchronizes the time record with the source waveform. Source Trigger is not valid for swept sine measurements.

For FFT measurements, the phase of signals which are synchronous with the trigger is stable. Vector averaging preserves these signals while attenuating random signals, thus increasing the dynamic range of the measurement.

The Trigger Source applies to both displays.

Command: TSRC (?) {i}

Trigger Level

Set the Trigger Level [-100% .. 99%]. The Trigger Level applies to Ch1, Ch2 and External Trigger Sources. The Trigger Level is specified as a percentage of the Input Range for Ch1 or Ch2 and as a percentage of 5 V for External trigger.

The trigger detector requires a minimum signal amplitude of 4% of the Input Range (200 mV for External). For Ch1 or Ch2 internal trigger, the signal must exceed -28 dBfs in order to trigger. Internal trigger is detected after the anti-aliasing filter (if On).

Command: TLVL (?) {i}

Trigger Slope

Select the Trigger Slope [Rising, Falling]. The Trigger Slope applies to Ch1, Ch2, External and Ext TTL Trigger Sources.

Command: TSLP (?) {i}

Delay A

Set the Trigger Delay for DisplayA [-8000..100000]. The Trigger Delay applies only to FFT measurements. The Trigger Delay is specified in samples (1/sampling rate) of the time record.

The triggered time record does not have to start with the trigger event. The time record can start before the trigger (negative delay) or after the trigger (positive delay). A delay of 0 starts the time record at the trigger. The Trigger Delay does not apply if the Trigger Mode is Free Run.

When a large trigger delay is used, the display may update slower since the acquisition time for each record (time record length plus trigger delay) is noticeably long.

Auto Arm Trigger Mode re-arms the trigger after both FFT displays have completed processing their time records.

Command: TDLA (?) {i}

Delay B

Set the Trigger Delay for DisplayB [-8000..100000]. The Trigger Delay applies only to FFT measurements. The Trigger Delay is specified in samples (1/sampling rate) of the time record.

The triggered time record does not have to start with the trigger event. The time record can start before the trigger (negative delay) or after the trigger (positive delay). A delay of 0 starts the time record at the trigger. The Trigger Delay does not apply if the Trigger Mode is Free Run.

When a large trigger delay is used, the display may update slower since the acquisition time for each record (time record length plus trigger delay) is noticeably long.

Auto Arm Trigger Mode re-arms the trigger after both FFT displays have completed processing their time records.

Command: TDLB (?) {i}

Trigd Source Mode

Set the trigger mode for the source [1-Shot, Continuous]. The Chirp, Burst Chirp, Burst Noise and Arbitrary sources are all triggered sources. This box is unavailable if the source is not a triggered source.

Free Run Trigger Mode outputs the source continuously and ignores this menu box.

Triggering

The triggered sources are triggered by External triggers.

In the 1-Shot case, the source only triggers on the first trigger after [Start/Reset]. This same trigger starts the measurement (and waterfall). This is useful when the source length is very long compared to the measurement time or many measurements are required to determine the response to a single source output. This allows a sequence of many measurements to be triggered at the start of a single triggered source output.

In the Continuous case, the source triggers on every trigger, with a minimum trigger period set by the source length (FFT time record, noise source period or arbitrary source length). This is useful when the source length is the same as the FFT time record length.

Do not use Ch1 or Ch2 input trigger since the output will not start until a trigger is received.

Source trigger outputs the source continuously over and over. FFT time records are synchronized to the source start.



Watch Out For Triggered Sources

If a triggered source is selected (Chirp, Burst Chirp, Burst Noise or Arbitrary), the triggered FFT measurement phase is stable only if the input signals are derived from the source output. Turn the source off (or set it to Sine) when making triggered measurements without the source.

Command: STMD (?) {i}

Manual Arm

Manually arm the trigger. This function only applies if the Trigger Mode is Manual Arm.

Manual Arm enables triggering after [Start/Reset] only after the trigger is armed using <Manual Arm> or from an interface command. Once the trigger is armed, the next trigger event will trigger the measurement.

For FFT measurements, each time record requires the trigger to be re-armed. For octave and swept sine measurements, the first trigger after arming starts the measurement and subsequent triggers are ignored.

Command: TARM

Manual Trigger

Trigger the measurements (and burst Chirp and Noise sources) regardless of Trigger Source.

Manual Trigger Source requires <Manual Trigger> or an interface command to trigger. Use Auto Arm Trigger Mode with since unwanted triggers are not a problem.

For FFT measurements, each time record requires a trigger. For octave and swept sine measurements, the first trigger after arming starts the measurement and subsequent triggers are ignored.

Command: TMAN

Average Menus

The Measurement Group (FFT, Octave Analysis or Swept Sine) determines which Average menu is displayed. This menu sets the averaging parameters for the measurement. A set of parameters is stored for each group.

FFT Average Menu

When the Measurement Group is FFT, this menu sets the averaging parameters for the active display. Averaging successive measurements together improves accuracy and repeatability.



Averaging

Select Averaging for the active display [Off, On].

Many FFT measurements have averaging as part of their definition (Transfer Function, Coherence, Auto Correlation and Cross Correlation). In these cases, the effect of averaging depends upon the exact measurement. If the measurement is Coherence, averaging is always on regardless of this menu.

Time records are not averaged.

The [Start/Reset] key resets the current average and starts a new average. The [Pause/Cont] key pauses the average in progress. Pressing [Pause/Cont] again will continue the average from where it was paused.

When Averaging is turned On, averaging starts immediately without pressing the [Start/Reset] key. When Averaging is turned Off (after a completed average), non-averaged measurements start immediately.

The Averaging of each display can be turned On and Off separately. This entry field can be linked to both displays by using the [Link] key.

Command: FAVG (?) d {, i}

Averaging Mode

Select the Averaging Mode for the active display [RMS, Vector, Peak Hold].

For a Coherence measurement, the Averaging Mode is pre-defined and this selection is ignored. For Auto or Cross Correlation, the Averaging Mode changes the definition of the measurement.

The [Start/Reset] key resets the current average and starts a new average. The [Pause/Cont] key pauses the average in progress. Pressing [Pause/Cont] again will continue the average from where it was paused.

If Averaging is On, changing the Averaging Mode resets the average and starts the new average immediately without pressing the [Start/Reset] key.

Each display has its own Averaging Mode. This entry field can be linked to both displays by using the [Link] key.

Command: FAVM (?) d {, i}

RMS Averaging

RMS averaging computes the average of the real part (X) and imaginary part (Y) of a measurement according to

$$X_{avg} = \sqrt{\text{mean}(X^2)} \text{ and } Y_{avg} = \sqrt{\text{mean}(Y^2)}$$

Linear averaging computes the equally weighted mean of X^2 and Y^2 over N measurements. Exponential averaging weights new data more than old data and yields a continuous moving average.

RMS averaging reduces fluctuations in the data but does not reduce the actual noise floor (squared values never cancel). With a sufficient number of averages, a very good approximation of the actual noise floor can be measured.

Log Magnitude View is normally used with rms averaged measurements. Since rms averaging involves squared values, the real and imaginary parts of the average are always positive. The phase of an rms averaged measurement is limited to the first quadrant (0-90 deg).

Vector Averaging

Vector averaging computes the average of the real part (X) and imaginary part (Y) of a measurement according to

$$X_{avg} = \text{mean}(X) \text{ and } Y_{avg} = \text{mean}(Y)$$

Linear averaging computes the equally weighted mean of X and Y over N measurements. Exponential averaging weights new data more than old data and yields a continuous moving average.

Since signed values are combined in the mean, random signals tend to average to zero. This reduces the noise floor since random signals are not phase coherent from measurement to measurement. Signals with a constant phase have real and imaginary parts which repeat from time record to time record and are preserved. Vector averaging can substantially improve the dynamic range of a measurement as long as the signals of interest have stable phases.

For single channel measurements, vector averaging requires a trigger. The signal of interest MUST be phase synchronous with the trigger to have a stable phase.

For a two channel measurement, the phase is relative between Channel 2 and Channel 1. As long as the signals of interest have stable relative phases, triggering is not required for vector averaging. Triggering is still required to isolate time records which contain the signals of interest.

The Time Record Increment is ignored whenever the measurement is vector averaged. Overlap processing is not allowed in this case and 100% increment is used.

Peak Hold Averaging

Peak Hold is not really averaging, rather the magnitude of the new data is compared to the magnitude of the averaged data, and if the new magnitude is larger, then the new data becomes the averaged data. This is done on a frequency bin by bin basis. The result is averaged data with the largest magnitudes which occurred over a number of measurements. Peak Hold can compare a Fixed Number of measurements or run Continuously.

Peak Hold detects the peaks in the magnitudes but stores the data points in their original complex form.

Averaging Type

Select the Averaging Type (weighting) for the active display. Choose Linear or Exponential if the Averaging Mode is RMS or Vector. Choose Fixed Length or Continuous if the Averaging Mode is Peak Hold.

The [Start/Reset] key resets the current average and starts a new average. The [Pause/Cont] key pauses the average in progress. Pressing [Pause/Cont] again will continue the average from where it was paused.

If Averaging is On, changing the Averaging Type resets the average and starts the new average immediately without pressing the [Start/Reset] key.

Each display has its own Averaging Type. This entry field can be linked to both displays by using the [Link] key.

Command: FAVT (?) d {, i}

Linear Weighting

Linear weighting combines N (Number Of Averages) measurements with equal weighting in either RMS or Vector averaging.

While Linear averaging is in progress, the number of averages completed is shown in the Horizontal Scale Bar below the graph. When the Number Of Averages has been completed, the measurement stops and 'Done' is displayed below the graph. If the 'Done' alarm is enabled, an audible alert is also sounded.

Waterfall Storage

If Waterfall Storage is on, the waterfall buffer only stores the completed linear averages, not each individual measurement. Each time the linear average is done, the result is stored in the waterfall buffer and the average is reset and started over (instead of stopping). Each completed average counts as a single waterfall record.

Exponential Weighting

Exponential weighting weights new data more than old data. For RMS and Vector averaging, weighting takes place according to the formula,

$$\text{Average}[N] = (\text{New Data})(1/N) + (\text{Average}[N-1])(N-1)/N$$

where N is the Number Of Averages.

While Exponential averaging is in progress, the number of averages completed is shown in the Horizontal Scale Bar below the graph. The displayed number stops incrementing at the Number of Averages while the averaging continues.

Exponential weighting reaches a steady state after approximately N measurements. Once in steady state, further changes in the average are detected only if they last for a sufficient number of measurements. Make sure that the number of averages is not so large as to eliminate changes in the data which might be important.

Fixed Length

For Peak Hold averaging, N (Number Of Averages) is the number of measurements which are compared. When N measurements have been completed, the measurement stops. When Fixed Length Peak Hold is in progress, the number of measurements completed is shown in the display.

Continuous

For Peak Hold averaging, the comparison of new data with the stored peaks continues indefinitely.

Number of Averages

Set the Number Of Averages for the active display [2..32767].

The Number Of Averages specifies the number of measurements for Linear and Fixed Length averages or the weighting of new data in Exponential averages.

The [Start/Reset] key resets the current average and starts a new average. The [Pause/Cont] key pauses the average in progress. Pressing [Pause/Cont] again will continue the average from where it was paused.

Changing the Number Of Averages does not start averaging.

Each display has its own Number Of Averages. This entry field can be linked to both displays by using the [Link] key.

Command: FAVN (?) d {, i}

Time Record Increment

Set the Time Record Increment for the active display [0% .. 300%]. The Time Record Increment is how far the start of each time record is advanced between measurements (as a percentage of the time record length).

If the increment is 100%, the start of the next time record is exactly one time record advanced from the start of the previous time record.

If the increment is 25%, then the next time record starts 1/4 of a time record advanced from the start of the previous time record. This is sometimes referred to as 75% overlap since the two time records share 75% of a record. The overlap is simply 100% minus the Time Record Increment.

When the Time Record Increment is less than or equal to 100%, the measurement is said to be 'real time'. All time points contribute to one (or more) measurements.

If the increment is 200%, the start of the next time record is advanced from the start of the previous time record by 2 time records leaving a gap of 1 record. This means that the data between the two time records is not measured.

When the Time Record Increment is greater than 100%, then the measurement is not 'real time' and some time points do not contribute to a measurement.

The actual time record increment for the measurements in progress is displayed in the Real Time indicator in the status area (below the Input Ranges). If the indicator shows a value greater than the requested Time Record Increment, it means that the measurement cannot be made with the requested increment but is running with the smallest increment possible. Factors which affect the processor's ability to run real time include the measurement type, averaging and source type.

100% Time Record Increment is used whenever the measurement is vector averaged.

The Time Record Increment is ignored whenever the measurement is triggered. In this case, the time records start with the trigger.

Settling

When the frequency span or input signal path (gain, filtering, etc.) is changed, a settling time is required before the FFT measurement is considered settled or valid. The measurement is not settled until the discontinuity in the input data has propagated through the digital filters and a complete new time record has been acquired.

If the time record increment is 100%, unsettled measurements are not displayed. After a change is made which unsettles the measurement, new data is not displayed until the filters are settled and a complete time record has been acquired.

If the measurement is running with a time record increment less than 100% and the measurement is unsettled, unsettled measurements may be displayed. New data is displayed after the filters are settled and a portion of the new time record has been acquired. For example, if the time record increment is 25%, 3 measurements are made before a complete new time record has been acquired. These first 3 measurements have time records which contain data from before AND after the measurement was unsettled. These unsettled measurements are displayed in half intensity indicating that the measurement is not settled. Once the 4th measurement is complete, the display returns to full intensity since the measurements have completely settled time records.

If averaging is on, changes which unsettle the measurement will restart the average. Unsettled measurements are not included in the new average. Averaging does not start until the measurement is settled. When the time record increment is less than 100%, 'Settle' is displayed (instead of the number of averages) below the graph to indicate that the unsettled measurements are not being averaged.

See also Real Time Bandwidth and Overlap.

Each display has its own Time Record Increment. This entry field can be linked to both displays by using the [Link] key.

Command: FOVL (?) d {, x}

Overload Reject

Select Overload Reject for both displays [Off, On].

When Overload Reject is On, time records which contain points which were overloaded at the input are not included in the measurement average. Whenever a time record is rejected, the 'Reject' indicator below the graph (next to the average type and number) turns on briefly. This has no effect if Averaging is Off.

When Overload Reject is Off, all time records are part of the measurement average. Overloads can greatly disturb the average so be certain that the correct Input Range is used.

Command: FREJ (?) d {, i}

Average Preview

Select Average Preview for both displays [Off, Manual or Timed].

When averaging is on, Average Preview allows each individual measurement to be accepted (added to the average) or rejected (not added to the average) based upon the input time records. This is useful for rejecting bad time records from corrupting an averaged measurement.

Choosing either Manual or Timed forces the frequency spans of the two displays to be linked. This makes the time records for the two measurements synchronous.

When Average Preview is Manual, each input time record is displayed after it is acquired. Choose <Accept> or <Reject> to either use or ignore the measurement based upon the displayed time record. After the time record is accepted or rejected, the display reverts back the measurement display until the next time record is available (usually triggered).

When Average Preview is Timed, the input time record is automatically accepted after the Preview Time (unless rejected first).

The preview time records are displayed in place of the actual measurements. For single channel measurements, the appropriate channel input time record is shown in each display. For 2-channel measurements, the DisplayA shows Ch1 time record and DisplayB shows Ch2 time record. In this case, use the dual display format to view both time records.

While the preview time records are displayed, the displays are labeled 'Preview' instead of 'Live' (in the Vertical Scale Bar). A 'Preview' display is much like an 'Off-Line' display in that its measurement parameters may not be changed. To adjust the measurement parameters of the actual measurement, either turn Average Preview to Off or pause the measurement.

Command: PAVO (?) d {, i}

Preview Time

Select the Preview Time for both displays [0.5 s .. 1 ks].

When Average Preview is Timed, the input time record is automatically accepted after the Preview Time (unless rejected first).

Command: PAVT (?) d {, x}

Accept

Accept the displayed preview time record and add the measurement to the average.

4-98 FFT Average Menu

Average Preview allows each individual measurement to be accepted (added to the average) or rejected (not added to the average) based upon the input time records. This is useful for rejecting bad time records from corrupting an averaged measurement.

Command: PAVA

Reject

Reject the displayed preview time record and do not add the measurement to the average.

Average Preview allows each individual measurement to be accepted (added to the average) or rejected (not added to the average) based upon the input time records. This is useful for rejecting bad time records from corrupting an averaged measurement.

Command: PAVR

Octave Average Menu

When the Measurement Group is Octave Analysis, this menu sets the averaging parameters for the active display.

Averaging	
Averaging Type	Exp. Time
Integration Time	100 ms
Confidence	0.125 dB
Power Bin	Total
Linear Avg. Mode	Triggered

Averaging Type

Select the Averaging Type for the active display [Linear Time, Exponential Time, Peak Hold, Equal Confidence].

Choosing Peak Hold also sets the Power Bin to Peak.

Octave measurements are always rms averaged to measure the power in each band.

The [Start/Reset] key resets the current averages and starts the measurement over. The [Pause/Cont] key pauses the measurement. Pressing [Pause/Cont] again resets the averages and starts the measurement over.

The Averaging Type of each display can be selected separately. This entry field can be linked to both displays by using the [Link] key.

Command: OTYP (?) d {, i}

Linear Time

The band filter outputs are equally weighted and averaged for an Integration Time.

While Linear averaging is in progress, the integration time completed is shown in the Horizontal Scale Bar below the graph. When the Integration Time has been completed, the measurement stops and 'Done' is displayed below the graph. If the 'Done' alarm is enabled, an audible alert is also sounded.

Waterfall Storage

If Waterfall Storage is On, the waterfall buffer only stores the completed linear averages, not each individual measurement.

When the measurement is free running (Free Run Trigger Mode), each time the linear average is done, the result is stored in the waterfall buffer and the average is reset and started over (instead of stopping). Each completed average counts as a single waterfall record.

4-100 Octave Average Menu

When the measurement is triggered, each linear average may be triggered as well. Set the Linear Avg Mode to choose triggered averages or automatically reset averages.

Exponential Time

New filtered data is weighted more than older data. The exponential ‘time constant’ is the Integration Time. Averaging continues indefinitely.

While Exponential averaging is in progress, the completed integration time is shown in the Horizontal Scale Bar below the graph. The displayed time stops incrementing at the Integration Time while the averaging continues.

Exponential weighting reaches a steady state after approximately an integration time. Once in steady state, further changes in the average are detected only if they last for a sufficient number of measurements. Make sure that the integration time is not so large as to eliminate changes in the data which might be important.

Equal Confidence

Equal Confidence averaging is exponential averaging where the integration time is set for each band separately. The integration times are set so that there is a 68% probability that the results are within the specified Confidence Level of the true mean for every band in the measurement. There is a 96% probability that the results are within twice the Confidence Level (in dB) of the true mean.

The effect of Equal Confidence averaging is that higher frequency bands have shorter time constants and lower frequency bands have longer time constants. This is very noticeable in the update of the display.

Averaging continues indefinitely.

Peak Hold

Peak Hold displays the peak output from each band filter. The peak detection continues indefinitely.

Choosing Peak Hold also sets the Power Bin to Peak.

Integration Time

Set the Integration Time for the active display [4 ms .. 1 ks] in 4 ms increments. The Integration Time affects Linear Time, Exponential Time, and Peak Hold averaging.

The minimum Integration Time is determined by the Lowest Band in the Octave display. 4 ms Integration Time is only available if the Lowest Band is 100 Hz or greater. Decreasing the Lowest Band below 100 Hz increases the minimum value of the Integration Time.

The [Start/Reset] key resets the current averages and starts the measurement over. The [Pause/Cont] key pauses the measurement. Pressing [Pause/Cont] again resets the averages and starts the measurement over.

Each display has its own Integration Time. This entry field can be linked to both displays by using the [Link] key.

Command: OTIM (?) d {, x}

Confidence

Set the Confidence Level for the active display [0.125 dB .. 2 dB]. The Confidence Level only affects Equal Confidence averaging.

The [Start/Reset] key resets the current averages and starts the measurement over. The [Pause/Cont] key pauses the measurement. Pressing [Pause/Cont] again resets the averages and starts the measurement over.

Each display has its own Confidence Level. This entry field can be linked to both displays by using the [Link] key.

Command: OCNF (?) d {, i}

Power Bin

Choose the type of broadband power measurement for the active display [Total, Impulse, L, Peak]. If the Averaging Type is Peak Hold, only Peak power may be selected. If the Averaging Type is not Peak Hold, Total, Impulse and L may be selected.

In addition to the octave bands, a broadband sound level is measured and displayed as the last band in the octave graph. Exponential averaged sound power (Leq) is calculated according to ANSI S1.4-1983, Type 0. Broadband Impulse and Peak measurements are made according to IEC 651-1979, Type 0.

Exponential averaged power (Leq), Impulse (I) and Peak (P) power are computed from real-time input data. These are broadband measurements and are not computed from the octave bands. The band-limited Total (T) power is computed from the octave bands.

Each display has its own Power Bin. This entry field can be linked to both displays by using the [Link] key.

Command: OIMP (?) d {, i}

Linear Average Mode

Choose how linear averaged octave measurements behave when triggered [Triggered, Continuous]. The Linear Avg Mode only applies for linear averaging when the Trigger Mode is Auto or Manual Arm.

When the Trigger Mode is Auto or Manual Arm, the Linear Average Mode determines how the measurement restarts.

4-102 Octave Average Menu

Triggered means that the next trigger after a measurement finishes starts the next measurement.

Continuous means that the next measurement starts immediately after the previous measurement finishes. Only the first measurement after [Start/Reset] is started with a trigger. This mode is useful for measuring reverberation where the first measurement is triggered with the noise burst (use the Burst Noise source with 1-Shot Trigd Source Mode) and subsequent measurements follow continuously. All complete averages are stored to a waterfall to examine the sound level decay.

When the Trigger Mode is Free Run, a linear averaged measurement starts with [Start/Reset] and finishes when the Integration Time is complete. The next measurement does not start until [Start/Reset] is pressed again (or the measurement is changed). If waterfall storage is on, the next measurement starts immediately after the previous measurement finishes.

Both displays must have the same Linear Average Mode.

Command: OLAT (?) d {, i}

Swept Sine Average Menu

When the Measurement Group is Swept Sine, this menu sets the settle and integration times. These parameters govern the measurement of both channels. See ‘Swept Sine’ in Chapter 2 for a discussion about swept sine measurement fundamentals.

Averaging	
Settle Time	20 ms
Settle Cycles	5
Integration Time	100 ms
Integration Cycles	10

Settle Time

Set the Settle Time in increments of 3.906 ms [7.8125 ms .. 1 ks]

At each frequency point, a settling time is allowed to pass before any measurement is made. This allows the device under test to respond to the frequency change. The Settle Time is rounded up to the next multiple of 3.906 ms. The actual settling time is the larger of the Settle Time and the Settle Cycles (rounded to the next multiple of 3.906 ms). The settling time is always a minimum of 1 cycle or 7.8125 ms.

Changes made to the Settle Time during a sweep take effect immediately.

The estimated sweep time is displayed in the Horizontal Scale Bar. This time is simply the sum of the Settle and Integrate times for all points in the sweep. Auto functions (Source Auto Level, Auto Range, Auto Resolution) will change the actual sweep time.

Command: SSTM (?) d {, x}

Settle Cycles

Set the number of Settle Cycles [1..32767].

At each frequency point, a settling time is allowed to pass before any measurement is made. This allows the device under test to respond to the frequency change. The actual settling time is the larger of the Settle Time and the Settle Cycles (rounded to the next multiple of 3.906 ms). The settling time is always a minimum of 1 cycle or 7.8125 ms.

Changes made to the number of Settle Cycles during a sweep take effect immediately.

The estimated sweep time is displayed in the Horizontal Scale Bar. This time is simply the sum of the Settle and Integrate times for all points in the sweep. Auto functions (Source Auto Level, Auto Range, Auto Resolution) will change the actual sweep time.

Command: SSCY (?) d {, i}

4-104 Swept Sine Average Menu

Integration Time

Set the Integration Time in increments of 3.906 ms [15.625 ms .. 1 ks].

At each frequency point, the inputs measure the signal at the source frequency. This is done by multiplying the input data by the source sine (and cosine) wave and averaging the results over an integration time. The actual integration time is always an exact number of cycles at the source frequency. This rejects signals which are at a different frequency, such as noise and harmonics. A long integration time results in a narrow detection bandwidth at the source frequency. This improves signal to noise at the cost of longer measurement times .

The Integration Time is converted to next largest number of exact cycles. The actual number of integration cycles is the larger of the Integration Time (in cycles) and the Integration Cycles. The integration time is always a minimum of 1 cycle or 15.625 ms.

To measure each point for the same amount of time (constant detection bandwidth), set the Integration Cycles to 1 and the Integration Time to the desired time. The Integration Time should be greater than 1 cycle of the lowest frequency in the sweep.

Changes made to the Integration Time during a sweep take effect immediately.

The estimated sweep time is displayed in the Horizontal Scale Bar. This time is simply the sum of the Settle and Integrate times for all points in the sweep. Auto functions (Source Auto Level, Auto Range, Auto Resolution) will change the actual sweep time.

Command: SITM (?) d {, x}

Integration Cycles

Set the number of Integration Cycles [1..32767].

At each frequency point, the inputs measure the signal at the source frequency. This is done by multiplying the input data by the source sine (and cosine) wave and averaging the results over an integration time. The actual integration time is always an exact number of cycles at the source frequency. This rejects signals which are at a different frequency, such as noise and harmonics. A long integration time results in a narrow detection bandwidth at the source frequency. This improves signal to noise at the cost of longer measurement times .

The integration time is an exact number of cycles. The actual number of integration cycles is the larger of the Integration Time (in cycles) and the Integration Cycles. The integration time is always a minimum of 1 cycle or 15.625 ms.

To measure each point for a time inversely proportional to the frequency, set the Integration Time to 15.625 ms (minimum) and the Integration Cycles to the desired number. Remember, the detection bandwidth increases with frequency in this case (the cycles get shorter) which may result in increased detected noise at higher frequencies.

Changes made to the number of Integration Cycles during a sweep take effect immediately.

The estimated sweep time is displayed in the Horizontal Scale Bar. This time is simply the sum of the Settle and Integrate times for all points in the sweep. Auto functions (Source Auto Level, Auto Range, Auto Resolution) will change the actual sweep time.

Command: SSCY (?) d {, i}

User Math Menu

The User Math menu sets up user defined measurements and math calculations.

Use a User Function to define measurements which are not already available in each Measurement Group. To make a measurement of a defined User Function, select the User Function as the Measurement for the active display.

See ‘User Math Functions’ in Chapter 2 for more.

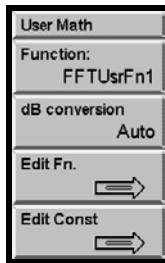

Function

To edit a User Functions, use the knob to choose a function and press [Enter]. Only the 5 User Functions within the current Measurement Group may be edited. The current definition of the functions is displayed as the knob moves through the list.

dB Conversion

Select the dB Conversion for the selected User Function [20log(), 10log(), Auto].

When a user function is selected as the Measurement for a display, the View and Units need to know how to compute dB from the dimensionless measurement data. If the function has linear units (e.g. FFT+FFT), then 20log() should be used. If the function has squared units (e.g. Octave or FFT*FFT), then 10log() should be used.

Auto chooses 10log() if any operand in the function is naturally a squared measurement. These include Coherence, Cross Spectrum, Correlation or Octave. Traces are always assumed to be linear. Otherwise, Auto chooses 20log(). No attempt is made to perform any dimensional analysis to determine the overall dimensions of the function.

Each function has its own dB Conversion stored with its definition.

Edit Function

Display the Edit Function menu to edit the selected User Function. Press <Cancel> to exit back to the main [User Math] menu .

To enter an equation, use <Operands> and <Operations> and the knob to select operands and operations. [<-] (Backspace) deletes the term before the cursor.

4-108 User Math Menu

To edit an equation, use <Func String> and the knob to move the flashing cursor within the equation. <Delete> will delete the highlighted term. <Operands> and <Operations> will either insert or replace at the cursor. Use <Insert/Replace> to switch between insert and replace mode. <Clear Eq> will delete the entire equation.

<Cancel> will discard any changes made in this menu and exit this menu.

<Enter Eq> will enter the new function equation and exit this menu. The new User Function definition is used immediately if it is being displayed.

Command: USRF (?) i {, j, k, l, m, ...} (FFT Group)

Command: USRO (?) i {, j, k, l, m, ...} (Octave Group)

Command: USRS (?) i {, j, k, l, m, ...} (Swept Sine Group)



Operands

Use the knob to pick one of the displayed Operands and press [Enter] to place it in the equation at the cursor location. The display then automatically switches to the Operations display. To enter another operand instead, press <Operands> again.

The available measurement operands depend upon the current Measurement Group.

FFT Measurement Group

Time(1)	Time(2)	FFT(1)	FFT(2)	Coherence()
X-Spec()	FFT2/FFT1()	<F2>/<F1>	Auto_Corr(1)	Auto_Corr(2)
X_Corr()	FFTa(1)	FFTb(2)	FFTu(1)	FFTu(2)
Const1	Const2	Const3	Const4	Const5
Trace1	Trace2	Trace3	Trace4	Trace5
j				

Octave Measurement Group

Oct(1)	Oct(2)			
Const1	Const2	Const3	Const4	Const5
Trace1	Trace2	Trace3	Trace4	Trace5
j				

Swept Sine Measurement Group

Spec(1)	Spec(2)	X-Spec()	Trans_Fn()	
Const1	Const2	Const3	Const4	Const5
Trace1	Trace2	Trace3	Trace4	Trace5
j				

Operands are arrays of complex values (real and imaginary). They may be measurement results (such as FFT(1), Time(1) or Oct(1)), a Trace, or a Constant. An array which is real simply has zero for its imaginary parts. The array length of an Operand is determined by the measurement length (number of FFT lines, length of time record, number of octaves, etc.) or Trace length (length of the data which is stored in the Trace). Constants assume the length of the user function.

Operands which are measurement results, such as FFT(1) or Oct(1), are exactly the same as the normal measurements. They are computed from the input data (real time Analog or capture Playback) and use the frequency and windowing parameters from the menus. Frequency domain measurements are amplitude calibrated, time records are not. FFT and Time record measurements are also triggered just like the normal measurements.

FFT(1) and FFT(2) are the FFT of the Ch1 and Ch2 inputs. These operands use the window chosen in the [Window] menu for the display which is measuring the function.

FFTa(1) is the FFT of the Ch1 input using the window for Display A, regardless of which display is measuring the function. FFTb(2) is the FFT of the Ch2 input using the window for Display B. This allows a function to be defined which uses both input channels, each with a different window. Force-exponential transfer function for example.

FFTu(1) and FFTu(2) are un-windowed FFT's of the Ch1 and Ch2 inputs.

Octave and Swept Sine measurements are always averaged measurements. Use the [Average] menu to set the averaging parameters.

Auto_Corr(1), Auto_Corr(2), X_Corr, $\langle F2 \rangle / \langle F1 \rangle$ and Coherence are all averaged FFT measurements, regardless of whether averaging is On or Off in the [Average] menu. The Averaging Mode is determined by the definition of the measurement. The Averaging Type (linear or expo) and the Number of Averages are set in the [Average] menu.

All basic FFT measurements, Time, X_Spec and FFT2/FFT1 are NOT averaged results. Use the Avg() or VecAvg() operators to perform explicit averaging on these operands.

4-110 User Math Menu

Trace operands are simply the data stored in the Traces. For example, Traces can hold reference data used for normalization or calibration. There are 5 Traces which can be stored. These Traces are shared by all 3 Measurement Groups.

Constants are complex constants which are the same for every array point. Constants such as pi are commonly used in equations. There are 5 user defined constants which are shared by all 3 Measurement Groups.

Operations

Use the knob to pick one of the displayed Operations and press [Enter] to place it in the equation at the cursor location. The display then automatically switches to the Operands display. To enter another operation instead, press <Operations> again.

The available operations depend upon the current Measurement Group.

FFT Measurement Group

+	-	x	/	(
)	Mag{	Phase{	Real{	Imag{
Mag ² {	Sqrt{	Conj{	Ln{	Exp{
FFT{	FFTu{	IFFT{	jOmega{	d/dx{
GrpDly{	Avg{	Vec Avg{	AWt{	BWt{
CWt{	[X/(1-X)]{			

Octave Measurement Group

+	-	x	/	(
)	Mag{	Phase{	Real{	Imag{
Mag ² {	Sqrt{	Conj{	Ln{	Exp{
AWt{	BWt{	CWt{	[X/(1-X)]{	

Swept Sine Measurement Group

+	-	x	/	(
)	Mag{	Phase{	Real{	Imag{
Mag ² {	Sqrt{	Conj{	Ln{	Exp{
jOmega{	d/dx{	GrpDly{	AWt{	BWt{
CWt{	[X/(1-X)]{			

Arithmetic operations (+, -, x, /) combine operand terms on a point by point basis. It is the user's responsibility to ensure that the operand terms have the correct X axis type and lengths in order to produce meaningful results.

View operations (Mag(), Mag²(), Phase(), Real (), Imag()) simply convert the complex operand array into the desired form. Mag() and Mag²() compute the magnitude ($\sqrt{x^2 + y^2}$) or magnitude squared ($x^2 + y^2$) with a real result. Phase() computes the phase ($\tan^{-1}(y/x)$) unwrapped with a real result. Real() simply zeroes the imaginary part. Imag() zeroes the real part.

Conj(), Ln(), Exp() and Sqrt() are defined as follows,

$$\begin{aligned} \text{Conj}(x + jy) &= x - jy \\ \text{Conj}(x - jy) &= x + jy \\ \text{Ln}(x + jy) &= \ln(r) + j\theta \\ \text{Exp}(x + jy) &= \exp(x) \cdot (\cos(y) + j\sin(y)) \\ \text{Sqrt}(x + jy) &= \sqrt{r} \cdot (\cos(\theta/2) + j\sin(\theta/2)) \\ [X/(1-X)] &= (x + jy)/(1 - x - jy) \end{aligned}$$

where $r = \sqrt{x^2 + y^2}$ and $\theta = \tan^{-1}(y/x)$. Sqrt computes all angles positive from 0. The $[X/(1-X)]()$ operator is generally used on real arguments only.

The $j\Omega$ operator is simply $j\omega$ and zeroes the real part and fills the imaginary part with the value of ω ($2\pi \cdot \text{frequency}$) at each point in the array. The frequency is determined by the span of the operand. A measurement operand (FFT(1) or Time(1)) uses the current frequency span. A Trace operand uses the span of the measurement which is stored in the Trace.

Not all operations are available in all Measurement Groups. Swept Sine and Octave measurements have no time records and thus the FFT() and IFFT() operators are not available. In addition, the results are always averaged so the Avg() and VecAvg() operators are also not required. FFT(), FFTu(), IFFT(), Avg() and VecAvg() are only available in the FFT Measurement Group.

FFT() is the windowed FFT operator. These operations switch the X axis type. The current window chosen in the [Window] menu is used on the operand before the FFT. FFTu() is the un-windowed FFT operator. The uniform window is always used. The FFT() and FFTu() operators do not calibrate their results since their operands are not necessarily input time records. To use a calibrated FFT, use the measurement operand FFT(1) or FFT(2).

IFFT() is the inverse complex FFT operation. This operation switches the X axis type.

The Avg() operator performs averaging on the operand. The [Average] menu turns averaging Off/On and selects the Mode, Type and Number of Averages. This operator allows the explicit use of averaging within a User Function. The measurement operands (FFT(1) or FFT(2)) are NOT already averaged. Use Avg() to perform averaging on operands or operand terms (e.g. Avg(FFT(1)) or Avg(FFT(2)/FFT(1))).

The VecAvg() operator always performs vector averaging on the operand. Averaging is performed regardless of the Average Off/On selected in the [Average] menu. The menu still determines the Average Type and Number of Averages.

$d/dx()$ is the derivative operator. The derivative is performed with respect to the X-axis bin number, not the x-axis values. For example, to convert $d/dx()$ to $d/df()$ for a linear

frequency display, divide by the frequency spacing of the bins. In the case where the X-axis is logarithmic, the function needs to correct for $d(\log x)/dx$. The $d/dx()$ operator requires a smoothing aperture or window.

$\text{GrpDly}()$ is the group delay operator. Group delay is simply $d\theta/d\omega$. Use [Display Options]<d/dx Window> to set the aperture. This operator yields valid results for any complex operand which has a frequency x-axis.

$\text{AWt}()$ is the A-Weighting operator. This filter is a software version of the input A-Weight filter. $\text{BWt}()$ and $\text{CWt}()$ are the software B-Weighting and C-Weighting operators. The $\text{AWt}()$, $\text{BWt}()$, and $\text{CWt}()$ operators should only be used on operands with a frequency x-axis. All three filters conform to ANSI Standard S1.4-1983.

Function String

Move the cursor to the function equation window at the top of the screen. Use the knob to move the highlighted cursor within the equation. <Delete> will delete the highlighted term. <Operands> and <Operations> will either insert or replace at the cursor. Use <Insert/Replace> to switch between insert and replace mode.

[<-] (Backspace) deletes the term before the cursor.

Insert/Replace

Toggle between insert and replace mode while editing a User Function equation.

If editing in insert mode, 'Ins' appears in the upper right corner of the edit window. If editing in replace mode, 'Rep' appears.

When editing a User Function equation, selecting <Operands> or <Operations> will insert or replace before the cursor location.

Delete

Delete the highlighted term in a User Function equation. To move the cursor in a User Function equation, use <Func String> and the knob.

Clear Eq.

Clear the entire equation definition. If a cleared User Function is entered, it will be undefined and unavailable for display. If a display is currently measuring this function, then it may not be cleared. In this case, change the measurement and then clear the equation.

Cancel

Discard any changes made in this menu and exit this menu.

Enter Eq.

Enter the displayed equation as the new User Function and exit this menu. The new User Function definition is used immediately if it is being displayed.

If the new function uses an incompatible or empty Trace it may not be displayed as a measurement. If a display is already measuring this function, then it may not be entered. In this case, change the measurement and then change the equation.

Edit Constant

Display the Edit Constant menu. Press <Return> or [User Math] for the main [User Math] menu .

Constants may be used as operands in a User Function. There are 5 constants which may be defined and are shared by all Measurement Groups.

Command: USRC (?) i {, x, y}

Edit Const
Constant Const1
Real Part 1
Imag Part 0
Mag 1
Phase (deg) 0
Marker->Mag <input type="checkbox"/>
Return <input type="checkbox"/>

Constant

Use the knob to pick one of the five Constants to edit and press [Enter].

Real Part

Enter a new value for the real part of the selected Constant. The imaginary part is left unchanged and the magnitude and phase are updated.

Command: USRC (?) i {, x, y}

Imaginary Part

Enter a new value for the imaginary part of the selected Constant. The real part is left unchanged and the magnitude and phase are updated.

Command: USRC (?) i {, x, y}

4-114 User Math Menu

Mag

Enter a new value for the magnitude of the selected Constant. The phase is left unchanged and the real and imaginary parts are updated.

Phase(deg)

Enter a new value for the phase (in degrees) of the selected Constant. The magnitude is left unchanged and the real and imaginary parts are updated.

Marker to Mag

Copy the marker reading (exactly as shown in the Marker Position Bar) of the active display to the magnitude of the selected Constant. No unit translation takes place. Make sure that the units of the active display are correct before using this feature.

Window Menu

The Window menu allows the user to choose the window function for FFT measurements. See 'Windowing' in Chapter 2 for more information.

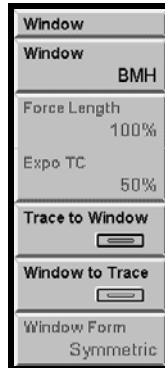

Window

Select the Window Function for the active display.

The two displays can have different Windows. This entry field can be linked to both displays by using the [Link] key.

The following windows are available for FFT, Windowed Time, Cross Spectrum, Transfer Function, Coherence and User Function measurements:

Command: FWIN (?) d {, i}

Uniform

The time record is used with no windowing. This window provides amplitude accuracy only for exact bin frequencies and very poor frequency selectivity. This window is a poor choice for continuous signals. In general, this window is only useful when looking at transients which do not last the entire time record. The uniform window may also be used with signals which are exactly periodic in the time record such as a chirp.

Hanning

The Hanning window is the most commonly used window. However, it has an amplitude variation of about 1.5 dB for off-bin signals and provides only reasonable selectivity. Its side-lobes are very high and broad for off-bin frequencies. As a result, the Hanning window can limit the performance of the analyzer when looking at signals close together in frequency and very different in amplitude. The Hanning window is most often used in noise measurements since it has the lowest noise floor.

Flattop

The Flattop window has the best amplitude accuracy of any window. Its off-bin amplitude variation is about 0.02 dB. However, the selectivity is worse. Unlike the other windows, the Flattop window has a very wide pass band and very steep rolloff on either

side. Thus, signals appear wide but do not leak across the whole spectrum. The Flattop window is the best window to use for accurate amplitude measurements.

BMH

The BMH window has reasonable off-bin amplitude accuracy (about 0.8 dB) and much lower side-lobes than the Hanning window. Thus, it has very good selectivity and very little broadening of non-bin frequencies. The BMH window is a good window to use for measurements requiring a large dynamic range.

Kaiser

The Kaiser window has the lowest side-lobes and least broadening for non-bin frequencies. This makes this window the best for selectivity. The off-bin amplitude variation is the same as the BMH (about 0.8 dB). The Kaiser window is the best window to use for measurements requiring a large dynamic range.

Force

The Force window is uniform over the beginning of the time record and zero over the remainder. The force length is user specified. This window is used to isolate impulsive signals, such as impact excitations, from noise and other oscillations later in the time record.

Exponential

The Exponential window attenuates the time record with a decaying exponential time constant. This window is often used in impact testing on the response channel to remove oscillations which last longer than the time record.

Force-Exponential

Many impact measurements require the Force window for one channel and the Exponential window for the other channel. Use User Math to define a 2 channel measurement using different windows for each input channel. For example, to measure a transfer function with a force window on Ch1 (impulse) and an exponential window on Ch2 (response), define a user function as $FFTb(2)/FFTa(1)$. In this case, the FFT of Ch2 uses the window of DisplayB and the FFT of Ch1 uses the window of DisplayA, regardless of which display is showing the function. Simply un-link the [Window]<Window> entry and assign the Force window to DisplayA and the Exponential window to DisplayB.

User Defined

The User window is any function that the user provides. The User window is copied from a stored trace using <Trace to Window>. The trace may contain stored data or may be loaded from disk or via the computer interface.

<Trace to Window> automatically changes the window of the active display to the User window. The User window is lost if the window type is changed. To switch back and forth between a User window and another window, keep using <Trace to Window>.

Remember, window functions have a great deal of impact on the resulting FFT spectrum. A poorly designed window can result in significant measurement errors.

Correlation Windows:

When the measurement is Auto Correlation, Cross Correlation, Windowed Time or a User Function, the available windows are:

[-T/2..T/2]

This is a uniform window which should only be used on data which is self windowing (lasts less than half of the time record).

[0..T/2]

This window zeroes the second half of the time record.

[-T/4..T/4]

This window zeroes the first and last quarter of the time record.

Octave and Swept Sine measurements do not use windows.

Force Length

Set the Force Window Length as a percentage of the FFT time record [1%..100%]. Points in the time record up to the Force Length are unmodified. Points in the time record past the Force Length are zeroed.

Choose Force as the FFT window before setting the Force Length.

The two displays can have different Force Lengths. This entry field can be linked to both displays by using the [Link] key.

Command: FWFL (?) d {, i}

Expo TC

Set the Expo Window Time Constant as a percentage of the FFT time record [5%..1000%]. This is the point where the window function reaches 1/e.

Choose Expo as the FFT window before setting the Expo Time Constant.

The two displays can have different Expo Time Constants. This entry field can be linked to both displays by using the [Link] key.

Command: FWTC (?) d {, i}

Trace to Window

Copy a stored data trace (real part only) to the User window function of the active display. Use the knob to pick a trace which already contains data and press [Enter]. The window automatically switches to User window.

4-118 Window Menu

The trace data is interpolated if necessary in order to provide the window function with the correct number of points. The trace length is mapped to the entire window length. The User window may be used with time records of any length.

<Trace to Window> is the only way to choose the User window. The User window is lost when the window is switched to another window type. Use <Trace to Window> to load the User window again.

Command: TRWI d, i

Window to Trace

Copy the current window of the active display to the real part of a stored data trace. Use the knob to pick a trace and press [Enter].

<Window to Trace> always stores a trace with 2048 points. This corresponds to the longest possible time record (800 line baseband). Using this trace in User Math requires attention to the lengths of other operands in any user function.

Command: WITR d, i

Window Form

Select the Window Form of the active display User window [Non-Symmetric, Symmetric].

Use Symmetric if the User window is centered or symmetric in the time record. Phase will be measured relative to the center of the time record. Uniform, Hanning, Flattop, BMH and Kaiser windows are all symmetric.



Use Non-Symmetric if the User window is non-symmetric. Phase will be measured relative to the start of the time record. Force and Exponential windows are non-symmetric.

Use <Trace to Window> to choose the User window.

Command: WSYM (?) d {, i}

Waterfall Menu

The Waterfall menu configures the waterfall displays. Waterfall displays are not available for Nyquist or Nichols Views or Swept Sine measurements.

Waterfall	
Display	Normal
Storage	Continuous
Total Count	494
Skip	30
View Count	10
Trace Height	70%
Angle	-30°
Cursor Z to	10
Allocate Mem.	
More...	

Display

Select the Normal or Waterfall Display for the active display. Waterfall Display only applies to FFT and Octave measurements. Waterfall displays are not available for Nyquist or Nichols Views or Swept Sine measurements.

Normal Display only shows the results of a single measurement.

Waterfall Display WITHOUT storage is simply a graphical display scrolling. The marker is constrained to the most recent record (at the back of the waterfall). Older records are only shown graphically, their data has not been saved and may not be accessed in any way. In this case, the display updates and scrolls as quickly as possible.

Waterfall display WITH storage shows only those records which are stored in waterfall memory. While the measurement is running, the display is scrolls down and the newest record is added to the top (back). While running, the display may not update fast enough to show every stored record in real time. Pause the measurement to redraw the display with either the newest record at the top (normal) or the oldest record at the top (reversed). When paused, the display shows every stored record which is visible. The number of records stored in waterfall memory is displayed in the Vertical Scale Bar when storage is on.

A waterfall display may not be taken Off-Line.

Moving the Marker

The marker may be moved to a record other than 0 only if storage is on.

4-120 Waterfall Menu

Use [Alt] knob to move the marker from record to record (along the Z axis) and scroll the display through the waterfall buffer. Use <Cursor Z to> to move to a specified record. The marker position along the Z axis is displayed in the Marker Position Bar next to the marker frequency or time. The Z axis position is the record number starting from 0 (most recently stored at the back of the waterfall). <Record to Trace> saves the record selected by the marker to a Trace.

Use the knob without [Alt] to move the marker along the X axis within a record. <Slice to Trace> saves a 'slice' to a Trace. A slice is the history of a single X position (data at the marker X position from all stored records).

The Waterfall Display for each display can be selected separately. This entry field can be linked to both displays by using the [Link] key.

Command: WDSP (?) d {, i}

Storage

Select the type of Waterfall Storage for the active display [Off, Continuous, One Shot, Recalled]. Waterfall storage is not available for Nyquist or Nichols Views or Swept Sine measurements.

Storage Off does not store any measurements to waterfall memory and changes the Waterfall Display to a graphical scroll only.

Continuous storage adds measurement records to the waterfall memory until [Pause/Cont] is pressed. The last Total Count number of records are saved in memory and may be displayed.

One shot stores the Total Count number of measurement records and pauses the waterfall storage. The first Total Count number of records are saved in memory. The measurement in the other display may continue on its own. Pause the measurements to scroll through the waterfall memory.

Recalled indicates that the waterfall buffer contains data which has been recalled from disk or loaded from the interface. Recalled waterfall data is *not* protected in any way! The recalled waterfall data behaves as if the measurement was paused. Pressing [Start/Reset] or changing any measurement parameter which normally causes the waterfall buffer to reset and take new data will *destroy the recalled data!* The recalled data is available for viewing and hardcopy only.

Waterfall memory must be allocated before waterfall storage may be used.

Linear Averaging

If Waterfall Storage is On, the waterfall buffer only stores the completed linear averages, not each individual measurement. Each time the linear average is done, the result is stored in the waterfall buffer and the average is reset and started over (instead of stopping). Each completed average counts as a single waterfall record.

Each display has its own Waterfall Storage Mode. This entry field can be linked to both displays by using the [Link] key.

Command: WSTO (?) d {, i}

Total Count

Set the Total Count (number of records) to store in the waterfall memory for the active display.

The maximum Total Count depends upon the allocated memory and the type of measurement. The amount of waterfall memory available for each display is always half of the allocated waterfall memory. For example, 500 blocks of allocated waterfall memory is allocated as 250 blocks for each display. For 400 line FFT measurements, each display can store 500 measurement records in this memory. Changing the measurement, frequency resolution or span may reduce the Total Count.

The Total Count is limited to 2000 records (per display) regardless of the amount of installed memory.

The rate at which measurement records are added to waterfall memory is set by the Waterfall Storage Interval. This allows the waterfall memory to hold a longer time history as well as setting a variable storage rate.

Each display has its own Total Count. This entry field can be linked to both displays by using the [Link] key.

Command: WTOT (?) d {, i}

Skip/Storage Interval

Set the Waterfall Skip/Storage Interval for the active display. The rate at which measurement records are added to waterfall memory is set by the Skip/Storage Interval. This allows the waterfall memory to hold a longer time history as well as setting a variable storage rate.

The interval has no effect if Storage is Off. The Waterfall Display updates at the normal rate for the display measurement and span.

In FFT group, for every measurement added to memory, a skip number of measurements are not stored. For example, a skip of 0 stores every measurement in memory. A skip of 10 stores every 11th measurement in memory (store 1, skip 10). The skipped measurements are still computed and affect (exponential) averaging, they are simply not stored. The elapsed time between stored records (1/storage rate) is simply skip+1 times the FFT acquisition time times the time record increment. (In the case of triggered measurements, skip+1 times the trigger period). This allows the time between stored records to be determined exactly.

In Octave group, the Storage Interval is set as a time. In this case, a snapshot is stored to memory every Storage Interval amount of time (4 ms minimum with 4 ms resolution).

4-122 Waterfall Menu

The Skip/Storage Interval has no effect if the measurement is linear averaged. In this case, the result of each complete linear average is stored in the waterfall buffer and the average is reset and started over again. Change the Number of Averages (FFT) or Integration Time (Octave) to change the storage rate.

Depending upon the storage rate, the waterfall display may not scroll fast enough to show every record being saved. In this case, the displays are redrawn with all visible records shown when the measurement is paused.

Each display has its own Waterfall Skip/Storage Interval Rate. This entry field can be linked to both displays by using the [Link] key.

Command: WFSK (?) d {, i} or WOSK (?) d {, x}

View Count

Set the Waterfall View Count for the active display [2..2000]. The View Count is the number of records shown within the display. This number is independent of the Total Count (number of records stored). The View Count is the Z axis scaling of the waterfall display and should be less than the Total Count in order to use the display are effectively.

Setting the View Count to a large number (>40 or so) will cause the display to skip some records. In this case, every nth record is drawn in order to show the desired View Count range of the waterfall buffer. A large View Count is a good way to display an overview of the entire buffer in order to identify a region of interest. Remember, View Count is strictly a display parameter, it does not affect the actual storage of waterfall records.

The View Count and the Trace Height determine the available scroll Angles.

Each display has its own Waterfall View Count. This entry field can be linked to both displays by using the [Link] key.

Command: WVCT (?) d {, i}

Trace Height

Set the Waterfall Trace Height for the active display [20%..80%]. The Trace Height specifies the percentage of the display height occupied by the Y axis of a single record.

The View Count and the Trace Height determine the available scroll Angles.

Each display has its own Waterfall Trace Height. This entry field can be linked to both displays by using the [Link] key.

Command: WHIT (?) d {, i}

Angle

Set the requested Waterfall Scroll Angle for the active display.

Waterfall displays show multiple measurement results (records) in a single display. New records are added at the top of the display and older records scroll off the bottom of the display. When the Scroll Angle is 0, the older records scroll straight down. When the Scroll Angle is negative, the older records shift left as they scroll down. When the Scroll Angle is positive, they shift right as they scroll down.

The View Count and the Trace Height determine the available scroll angles. When Fast Angles is On, the available scroll angles are limited to those which scroll faster (due to the graphics architecture). This menu box sets the requested scroll angle. The display scrolls at the allowed angle closest to the requested angle. When adjusted with the knob, only available angles are selected.

Each display has its own Waterfall Scroll Angle. This entry field can be linked to both displays by using the [Link] key.

Command: WANG (?) d {, i}

Allocate Memory

Display the Memory Allocation menu.

Total Available

Displays the total memory available for storage, either 992, 2016 or 4066 blocks, depending upon the amount of installed memory. Each block is 2 kPoints (2048 points).

The total of the Capture, Waterfall and Arbitrary memory allocations cannot exceed the Total Available memory. It may be necessary to decrease one allocation in order to increase another.

Command: MMEM ?

Capture Memory

Allocates memory blocks for the capture buffer. The allocated Capture Memory sets the limit for the Capture Length. Capture memory must be allocated before the capture buffer may be used.

Waterfall Memory

Allocates memory blocks for waterfall storage. Waterfall memory must be allocated before waterfall displays may be used.

Arb. Memory

Allocates memory blocks for the Arbitrary Source waveform. The Arbitrary Source can also use the capture buffer as the output waveform.

Clear Allocation

Clears the existing memory allocations in this menu.

Confirm Allocation

Places the memory allocations in this menu into effect. Exiting this menu without pressing <Confirm Allocation> will cancel any adjustments made in this menu.

4-124 Waterfall Menu

Command: MALC i, j, k

Marker to Z

Move the marker to a specified record within the waterfall buffer in the active display. Storage must be on to move to records other than the most recent (record 0). Enter a record number (starting from 0 as the most recent) and press [Enter]. The waterfall display will re-draw to include the specified record number.

[Alt] knob also moves the marker from record to record (along the Z axis) and scrolls the display through the waterfall buffer. <Marker to Z> is a faster way to move to an arbitrary record.

The marker position along the Z axis is displayed in the Marker Position Bar next to the marker frequency or time. The Z axis position is the record number starting from 0 (most recently stored at the back of the waterfall). <Record to Trace> saves the record selected by the marker to a Trace.

Command: MWFL d, i

More

Display the More Waterfall menu. Press <Return> or [Waterfall] for the main Waterfall] menu.

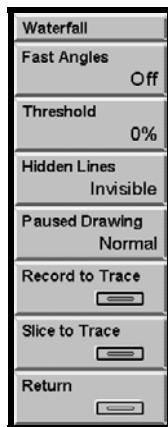

Fast Angles

Select the Waterfall Fast Angles for the active display [On, Off].

The View Count and the Trace Height determine the available scroll Angles. When Fast Angles is On, the available Scroll Angles are limited to those which update faster (due to the graphics architecture).

Each display has its own Fast Angles mode. This entry field can be linked to both displays by using the [Link] key.

Command: WFST (?) d {, i}

Threshold

Set the Waterfall Threshold for the active display [0%..99%]. The Threshold is specified as a percentage of the Y axis (Trace Height). Only those portions of each record which exceed the Threshold are displayed. This removes baseline noise from the waterfall display.

Note that the marker still moves along the actual data in each record, even if it is below the threshold. In this case, the marker will be located where there is no displayed data. The Marker Position Bar displays the actual data value in all cases.

Each display has its own Waterfall Threshold. This entry field can be linked to both displays by using the [Link] key.

Command: WTHR (?) d {, i}

Hidden Lines

Set the Waterfall Hidden Line Mode for the active display [Invisible, Visible]. In a waterfall display, as the older records scroll downward, they are considered to move towards the 'front' of the display. New records which appear at the top are 'behind' the older records. Invisible Hidden Lines will remove the portions of the new record which are 'behind' older records. This cleans up a waterfall display by removing intersecting lines. If records at the front of the waterfall are obscuring details hidden behind them, reverse the waterfall direction.

Each display has its own Waterfall Hidden Line Mode. This entry field can be linked to both displays by using the [Link] key.

Command: WHID (?) d {, i}

Paused Drawing

Set the waterfall display direction for a paused measurement [Normal, Oldest at Top].

While the measurement is running, the waterfall display scrolls down and the newest record is added to the top (back) of the waterfall.

When the measurement is paused, the waterfall is redrawn with either the newest record at the top (Normal) or reversed (Oldest at Top). If records at the front of the waterfall are obscuring details 'hidden' behind them, reverse the waterfall direction.

Each display has its own Paused Drawing Mode. This entry field can be linked to both displays by using the [Link] key.

Command: WREV (?) d {, i}

Record to Trace

Save a single record or measurement from the waterfall to a Trace. <Record to Trace> saves the record selected by the marker to a Trace. Choose a Trace with the knob and press [Enter] to complete the operation.

A stored trace can be recalled to a Display or Reference Display, used in a User Math Function, saved to disk, or copied to the Arbitrary Waveform buffer.

When the measurement is paused, use [Alt] knob to move the marker from record to record (in the Z axis) and scroll the display through the waterfall memory. Use the knob without [Alt] to move the marker along the X axis within a record.

Command: WTRC (?) d, i, j

Slice to Trace

Save a time 'slice' from the waterfall to a Trace. A slice is the history of a single X position (data at the marker X position from all stored records). Choose a Trace with the knob and press [Enter] to complete the operation.

The stored slice contains as many points as were stored in the Waterfall buffer (up to Total Count). The points in a slice trace are numbered and displayed from 0 (data from oldest record) to n (data from newest record). Note that this differs from the waterfall display in which the newest record is numbered 0. A recalled slice resemble a time record (X axis is time advancing left to right) with the X axis labeled as waterfall record number (instead of time).

A stored slice trace can be recalled to a Display or Reference Display, used in a User Math Function or saved to disk. A slice can not be copied to the Arbitrary Waveform buffer.

Command: WSLC (?) d, i, j

Capture Menu

The Capture menu configures the Capture Buffer. See ‘Capture Buffer’ in Chapter 2 for more information.

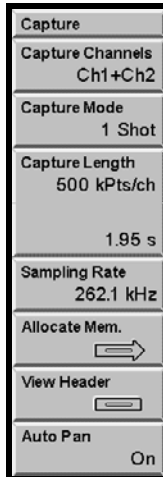

Capture Channels

Select which inputs to capture [Ch1, Ch2, Ch1+Ch2]. Choose either input or both inputs.

Capturing a single input limits playback to measurements of a single input.

Capturing both inputs allows playback of all measurements but the Capture Length will be half as long as for a single input.

Turn off Auto Offset during capture to avoid interrupting the input signal.

Command: CCHN (?) {i}

Capture Mode

Select the Capture Mode [1 Shot, Continuous].

Press [Start Capture] to begin storing data in the capture buffer. If the Capture Mode is 1 Shot, capture stops when the buffer is full. Press [Stop Capture] to halt capture before the buffer is full.

If the Capture Mode is Continuous, once capture is started, it continues indefinitely and fills the capture buffer in a circular fashion. In this case, press [Stop Capture] to halt capture with the most recent data in the buffer.

Command: CMOD (?) {i}

4-128 Capture Menu

Capture Length

Set the Capture Length in 2 kPoint (2048 points) increments.

Memory is allocated in blocks. Each block is 2 kPoints. Thus 500 blocks of capture memory allows a maximum Capture Length of 1000 kPoints for a single input and a maximum Capture Length of 500 kPoints for two inputs.

The Capture Length can be less than the allocated memory.

Command: CLEN (?) {i}

Sampling Rate

Select the capture Sampling Rate. The Sampling Rate can be 1, 1/2, 1/4, 1/8, ... times the maximum sampling rate.

The inputs are always digitized at the maximum sampling rate. The maximum sampling rate is 262.1 kHz when the FFT Base Frequency is 102.4 kHz and 256 kHz when the FFT Base Frequency is 100.0 kHz OR the Measurement Group is Octave.

If the selected capture Sampling Rate is the maximum rate, then the digitized input data is stored in the capture buffer. If the Sampling Rate is less than the maximum rate, the input data is filtered and downsampled to the desired rate and then stored in the capture buffer. This allows the capture buffer to hold a longer time period of data at a lower bandwidth. The captured data represents a frequency span from 0 Hz to 1/2.56 times the Sampling Rate. Capturing at less than the maximum sampling rate restricts the playback measurement span to 1/2.56 times the sampling rate.

Command: CRAT (?) {i}

Allocate Memory

Display the Memory Allocation menu.

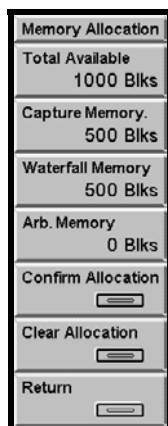

Total Available

Total Available displays the total memory available for storage, either 1000, 2000 or 4000 blocks, depending upon the amount of installed memory. Each block is 2 kPoints (2048 points).

The total of the Capture, Waterfall and Arbitrary memory allocations cannot exceed the Total Available memory. It may be necessary to decrease one allocation in order to increase another.

Command: MMEM ?

Capture Memory

Capture Memory allocates memory blocks for the capture buffer. The allocated Capture Memory sets the limit for the Capture Length.

Command: MALC i, j, k

Waterfall Memory

Waterfall Memory allocates memory blocks for waterfall storage.

Command: MALC i, j, k

Arb Memory

Arb. Memory allocates memory blocks for the Arbitrary Source waveform. The Arbitrary Source can also use the capture buffer as the output waveform.

Command: MALC i, j, k

Confirm Allocation

Confirm Allocation places the new memory allocations into effect. Exiting this menu without pressing <Confirm Allocation> will cancel any adjustments made in this menu.

Clear Allocation

Clear Allocation clears the existing memory allocations in this menu. The new allocations do not take effect unless <Confirm Allocation> is pressed.

View Header

View information about the capture buffer data.

Auto Pan

Set Auto Pan On or Off.

4-130 Capture Menu

Auto Pan On automatically pans zoomed capture buffer displays to keep up with capture fill and playback. The measurement must be a capture buffer and the display needs to be Zoomed in order for this to have any effect. During capture fill, this keeps the capture display showing the new points being added to the buffer. During playback, this keeps the capture display showing the points which are currently being measured.

Off leaves the display Pan to that set in the [Display Setup] menu.

Command: CPAN (?) {i}

Analysis Menu

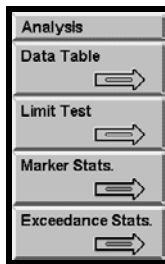

Data Table

Display the Data Table menu for the active display.

The Data Table reports the Y data values for user specified X coordinates. For example, the entries could be a set of harmonic frequencies which need monitoring. Each display has its own Data Table though only the table associated with the active display is shown at any time. If the Display Format is Dual, the active display's Data Table is in the inactive display's location. If the Display Format is Single, the Format is first changed to Dual.

To generate a report of the measurement, the active display Data Table may be printed. Choose ASCII Dump for the [Output] <Hard Copy Button> and use [Print Screen].

Data Table x coordinates are saved to disk with the instrument settings.

A Data Table with coordinates defined in the frequency domain will revert to bin locations if the measurement is changed to the time domain (and vice versa). Data Tables are generally only applicable for the domain (time or frequency) and span in which they were originally defined.

Limit Test

Display the Limit Test menu for the active display.

Limit Testing tests the measurement results against a set of defined Limit Segments. When display data exceeds a Limit Segment at any point, the test fails. Each display has its own set of Limit Segments. Limit Segments are saved to disk with the instrument settings.

A Limit Segment is defined as the line between the pair of points (X0,Y0) and (X1,Y1). The segment values between the endpoints are calculated for the displayed span. A segment may be defined as either an Upper or Lower limit. Measurement data which is greater than an Upper limit or less than a Lower limit cause the test to fail.

Limit Segments are defined for the current View. Changing the View invalidates the Limit Segments and limit testing is not available in the new View. Either return to the

4-132 Analysis Menu

original View or define new segments in the new View. Limit testing is not available for Nyquist or Nichols views.

Measurement data is compared with the limits only over the range of X values for which Limit Segments have been defined. Segments do not have to cover the entire display span or connect with each other. Only segments or the portions of segments within the measurement span are tested. Limits outside the measurement span are ignored.

The test result is shown in the display (to the left of the graph). An audible alarm may be sounded when a test fails.

Marker Stats

Display the Marker Statistics menu.

The Marker Statistics menu displays various statistics about the marker Y values including Mean, Max, Min and Standard Deviation.

When Marker Statistics are On, the various statistical quantities are updated whenever new data is available on the display. The accumulation of the statistical quantities continues even when this menu is not displayed. Return to this menu to see the latest statistical values.

Exceedance Stats

Display the Exceedance Statistics menu.

This menu is used to calculate L_n (exceedance centile) from Octave or FFT measurements stored in the waterfall buffer. The calculation of L_n requires that the active display have records stored in the waterfall buffer. The display must be paused or done with a 1-shot waterfall. Waterfall display is not required to be on.

L_n is the amplitude at each bin which is exceeded by n% of the records in the waterfall. L_1 is a large amplitude exceeded only 1% of the time. L_{99} is a small amplitude exceeded by 99% of the measurements.

The range of records within the waterfall buffer which are analyzed is specified by the Start and Stop index. The Exceedance Pct sets the centile (1-99).

Press <Calculate Excd> to start the calculation. The result is stored in a data trace and has the same measurement type as the waterfall measurements. To view the result, recall the trace to a display or reference graph.

Data Table Analysis Menu

The Data Table menu is used to edit and display the data table for the active display.

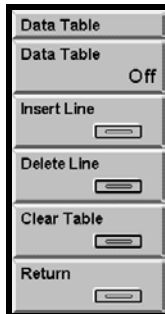

Data Table

Turn the Data Table display for the active display On or Off. The Data Table is shown in the inactive display's location. If the Display Format is Single, the Format is first changed to Dual. Turning off the Data Table does not change the Display Format back.

Command: DTBL (?) d {, i}

Insert Line

Insert a new line in the Data Table for the active display. This key has no effect unless the Data Table is turned On.

Move the marker to the desired frequency (or time) and press this key to insert a new line in the Data Table. The new line will be inserted after the highlighted entry. To select an entry in the table, use the backspace key [`<-`] or press [Alt] and turn the knob. Press [Alt] again to return the keypad to normal mode.

Command: DINS d, i, x

Delete Line

Delete the highlighted line in the Data Table display for the active display. This key has no effect unless the Data Table is turned On. To select an entry in the table, use the backspace key [`<-`] or press [Alt] and turn the knob. Press [Alt] again to return the keypad to normal mode.

You can not delete all of the entries in the table.

Command: DDLT d, i

4-134 Data Table Analysis Menu

Clear Table

Clear the Data Table for the active display. The table is left with a single entry for the first bin in the display.

Command: DCLR d

Limit Testing Analysis Menu

The Limit Testing menu is used to edit the limits and display the limit test results for the active display.

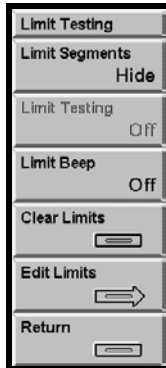

Limit Segments

Display the Limit Segments in the active display [Hide, Show].

Hide turns off the Limit Segments in the display. Limit testing may still be performed.

Show displays the Limit Segments in the display. Choosing <Edit Limits> also sets this to Show.

Command: LSON (?) d {, i}

Limit Testing

Turn Limit Testing for the active display On or Off.

Off turns off limit testing. The limit segments are not affected.

On turns on limit testing. Test results [Pass, Fail] are shown in the display to the left of the graph. Limit testing may not be turned on until there is at least one defined limit segment.

Command: LTST (?) d {, i}

Limit Beep

Turn the audible Limit Alarm for the active display On or Off.

Off turns off the alarm.

On turns on the alarm. Limit tests which fail will sound an audible alarm.

Command: LALM (?) d {, i}

4-136 Limit Testing Analysis Menu

Clear Limits

Clear the Limit Segments for the active display. All limit segments are cleared and Limit Testing is turned Off.

Command: LCLR d

Edit Limits

Display the Edit Limits menu. Press <Return> for the <Limit Test> menu. Choosing this menu also Shows Limit Segments.

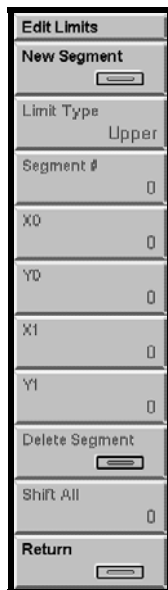

The screenshot shows a vertical menu titled "Edit Limits". The menu items are: "New Segment" with a right-pointing arrow; "Limit Type" with "Upper" selected; "Segment #" with "0"; "X0" with "0"; "Y0" with "0"; "X1" with "0"; "Y1" with "0"; "Delete Segment" with a right-pointing arrow; "Shift All" with "0"; and "Return" with a right-pointing arrow.

New Segment

Add a new segment to the Limit Test for the active display. The new segment starts at the end of the last existing segment. This simplifies the building of a continuous limit table. The new segment is also the Current Segment.

Command: LMAX (?) d {, i}

Limit Type

Select the Limit Type for the Current Segment [Upper, Lower]. Each segment is identified by small triangular arrow markers at the segment end points. These markers are above the segment and point downwards for Upper limits. They are below the segment and point upwards for Lower limits.

Command: LSEG (?) d, i {, j, x0, y0, x1, y1}

Segment #

Select the Current Segment for editing [0..n]. The limit Type and Start (X0, Y0) and End (X1, Y1) points for this segment are edited in this menu. The Current Segment is identified by two triangular arrows located at the segment endpoints. These arrows are above the Upper or below the Lower Limit Type markers.

Use <Delete Segment> to remove this segment. The numbering of the remaining segments may change as a result. Use the Current Segment markers to identify the correct segment before editing.

X0

Enter or adjust the X coordinate for the Current Segment Start point. The X coordinates are assumed to be in the display units (usually Hz).

Use Zoom and Pan to expand the display when drawing small segments.

Command: LSEG (?) d, i {, j, x0, y0, x1, y1}

Y0

Enter or adjust the Y coordinate for the Current Segment Start point. The Y coordinates are assumed to be in the display units.

Use Zoom and Pan to expand the display when drawing small segments.

Command: LSEG (?) d, i {, j, x0, y0, x1, y1}

X1

Enter or adjust the X coordinate for the Current Segment End point. The X coordinates are assumed to be in the display units (usually Hz).

Use Zoom and Pan to expand the display when drawing small segments.

Command: LSEG (?) d, i {, j, x0, y0, x1, y1}

Y1

Enter or adjust the Y coordinate for the Current Segment End point. The Y coordinates are assumed to be in the display units.

Use Zoom and Pan to expand the display when drawing small segments.

Command: LSEG (?) d, i {, j, x0, y0, x1, y1}

Delete Segment

Delete the Current Segment. The numbering of the remaining segments may change as a result. Use the Current Segment markers to identify the correct segment before editing.

4-138 Limit Testing Analysis Menu

Command: LDLT d, i

Shift All

Shift all of the Limit Segments up or down together. Enter a value or use the knob to shift by 1/10's of a division.

Command: LSFT d, x

Marker Statistics Menu

The Marker Statistics menu displays various statistics about the marker Y values.

Marker Statistics	
Marker Stats.	On
Reset	<input type="button" value="Reset"/>
Max (Display A)	-6.0179
Min	-6.0189
Mean	-6.0185
Std. Dev.	0.00029156
Max (Display B)	-6.0154
Min	-6.0164
Mean	-6.0158
Std. Dev.	0.00029351

Marker Stats.

Turn the accumulation of marker statistics On or Off.

When Marker Statistics are On, the various statistical quantities are updated whenever new data is available on the display. The accumulation of the statistical quantities continues even when this menu is not displayed. Return to this menu to see the latest statistical values.

When Marker Statistics are Off, the various quantities are frozen. New data is not included in the statistics.

Command: MSAO (?) d {, i}

Reset

Reset and start the accumulation of marker statistics. The various quantities are reset to zero and the accumulation of marker statistics begins.

Use this key whenever the marker position is changed to avoid mixing data from different marker positions.

Command: MSRS

4-140 Marker Statistics Menu

Max (Display A)

This menu box displays the maximum value of the marker Y value for display A since Marker Stats was turned On or Reset.

This max value is updated whenever new data is available for Display A and does not update if Display A is not visible.

Command: MSAA ?

Min (Display A)

This menu box displays the minimum value of the marker Y value for display A since Marker Stats was turned On or Reset.

This min value is updated whenever new data is available for Display A and does not update if Display A is not visible.

Command: MSIA ?

Mean (Display A)

This menu box displays the mean value of the marker Y value for display A since Marker Stats was turned On or Reset.

This mean value is updated whenever new data is available for Display A and does not update if Display A is not visible.

Command: MSEA ?

Std. Dev. (Display A)

This menu box displays the standard deviation of the marker Y value for display A since Marker Stats was turned On or Reset.

This standard deviation is updated whenever new data is available for Display A and does not update if Display A is not visible.

Command: MSSA ?

Max (Display B)

This menu box displays the maximum value of the marker Y value for display B since Marker Stats was turned On or Reset.

This max value is updated whenever new data is available for Display B and does not update if Display B is not visible.

Command: MSAB ?

Min (Display B)

This menu box displays the minimum value of the marker Y value for display B since Marker Stats was turned On or Reset.

This min value is updated whenever new data is available for Display B and does not update if Display B is not visible.

Command: MSIB ?

Mean (Display B)

This menu box displays the mean value of the marker Y value for display B since Marker Stats was turned On or Reset.

This mean value is updated whenever new data is available for Display B and does not update if Display B is not visible.

Command: MSEB ?

Std. Dev. (Display B)

This menu box displays the standard deviation of the marker Y value for display B since Marker Stats was turned On or Reset.

This standard deviation is updated whenever new data is available for Display B and does not update if Display B is not visible.

Command: MSSB ?

Exceedance Statistics Menu

The Exceedance Statistics menu calculates exceedance centile statistics from Octave and FFT measurements stored in the waterfall buffer.

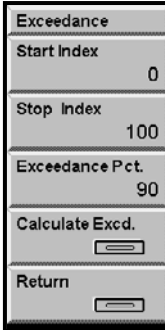

The screenshot shows a menu titled "Exceedance" with the following fields and buttons:

Exceedance	
Start Index	0
Stop Index	100
Exceedance Pct.	90
Calculate Excd.	<input type="button" value="=>"/>
Return	<input type="button" value="=>"/>

Start Index

Set the starting record in the waterfall buffer for the calculation of L_n (exceedance centile). The analysis starts at the start index and includes all records through the stop index.

Index 0 is the most recent record, larger indexes are older.

The total number of records currently stored and available in the waterfall buffer is displayed in the Vertical Scale Bar. The Start Index should not exceed the total number of records in the buffer.

Both displays use the same Start Index.

Command: ESTR (?) {i}

Stop Index

Set the stop record in the waterfall buffer for the calculation of L_n (exceedance centile). The analysis starts at the start index and includes all records through the stop index.

Index 0 is the most recent record, larger indexes are older.

The total number of records currently stored and available in the waterfall buffer is displayed in the Vertical Scale Bar. The Stop Index should not exceed the total number of records in the buffer.

Both displays use the same Stop Index.

Command: ESTP (?) {i}

Exceedance Pct

Set the Exceedance Centile (L_n).

L_n is the amplitude at each bin which is exceeded by $n\%$ of the records in the waterfall. L_1 is a large amplitude exceeded only 1% of the time. L_{99} is a small amplitude exceeded by 99% of the measurements.

The range of records within the waterfall buffer which are analyzed is specified by the Start and Stop index.

Both displays use the same Exceedance Centile.

Command: EPCT (?) {i}

Calculate Excd

Start the exceedance centile calculation for the active display. Choose a Trace to store the result and press [Enter] to proceed.

The display must be paused or done with a 1-shot waterfall. Waterfall display is not required to be on.

The result is stored in a data trace and has the same measurement type as the waterfall measurements. To view the result, recall the trace to a display or reference graph.

Command: EXCE d, i

Disk Menu

The Disk menu saves and recalls data and settings to and from disk. Utility functions are provided to manage directories, erase files and format disks. Files are saved as DOS files on either 720k or 1.4M 3.5 inch disks.



File Name

Enter the save and recall Current File Name.

Turn the knob to bring up the file catalog display listing all files in the Current Directory with the extension .78? (SR780 files). Press [Exp] to display all files in the directory (*.*). Choose a file name with the knob and press [Enter] to make it the Current File Name. This file name is used for saving and recalling displays, traces and settings. Remember, saving to this file will write over the existing file!

New file names are entered using the [Alt] key and the letters associated with each key. Press [Alt] again to return to normal keypad operation. DOS file name conventions must be followed. File names are 8 characters or less with an extension (.ext) of up to 3 characters. Default extensions are automatically supplied if no extension is specified. The default extensions should be used since the directory display assumes an extension appropriate for the current menu.

Command: FNAM (?) {s}

Command: FREE ?

Command: FXST ? s

Command: FRST ?

Command: FNXT ?

Current Directory

Enter the Current Disk Directory.

Turning the knob will bring up the directory tree display which lists all of the sub-directories on the disk. Choose a directory with the knob and press [Enter] to make it the Current Directory.

A directory may be entered using the [Alt] key and the letters associated with each key. Press [Alt] again to return to normal keypad operation. An error results if the entered directory does not exist.

New directories are created with <Make Directory>.

Command: FDIR (?) {s}

Display to Disk

Save the active display data to the Current File in the Current Directory. If the Current File has no specified extension, the default extension .78D is used.

The measurement, frequency span, averaging and window are stored with the data in order to preserve the integrity of the data when recalled.

Command: FSAV d

Disk to Display

Recall data from the Current File in the Current Directory to the active display. The active display will be set to Off-Line when data is recalled to it. The display will not update with live measurement results until the Display is set back to Live (in the [Display Options] menu).

The measurement, frequency span, averaging and window are recalled with the data and cannot be changed. These menus are shown in gray and reflect the settings or values for the last Live measurement. Parameters which pertain to the display of the data, such as scale and view, may be changed in the [Display Setup] and [Display Options] menus.

When the Display is returned to Live, the measurement, frequency span, averaging and window all return to the settings in effect before the data was recalled and the live measurement returns to the display.

Command: FRCL d

Settings to Disk

Save the instrument settings to the Current File in the Current Directory. If the Current File has no specified extension, the default extension .78S is used.

The entire instrument setup is stored to the file. Portions of the setup may be excluded from the recall.

Command: SSAV

Recall Settings

Display the Recall Settings menu. Choose the portions of the setup to recall from the Current File in the Current Directory. The recalled settings become effective immediately.

Press [Disk] again to return to the main Disk menu.

Command: SRCL i

Trace to Disk

Save Trace data to the Current File in the Current Directory. If the Current File has no specified extension, the default extension .78D is used.

Select a Trace # (1..5) with the knob and press [Enter] to save it to disk. Only traces which currently have data in them may be selected. To save a display to a Trace, use [Display to Trace] ([Alt] [Print Screen]).

Command: TSAV i

Disk to Trace

Recall data from the Current File in the Current Directory to a Trace. If the Current File has no specified extension, the default extension .78D is used.

Select a Trace # (1..5) with the knob and press [Enter] to recall from disk to the Trace. The recalled data will replace any data presently stored in the Trace.

A stored trace can be recalled to a Display or Reference Display, used in a User Math Function or saved to disk.

Command: TRCL i

Buffers

Display the Disk Buffers menu. Press <Return> or [Disk] for the main Disk menu. The Disk Buffers menu loads traces from disk files. It also loads and saves Capture, Arbitrary Source and Waterfall data buffers to disk.

4-148 Disk Menu

Disk Upkeep

Display the Disk Upkeep menu. Press <Return> or [Disk] for the main Disk menu. The Disk Upkeep menu allows files to be deleted, directories to be created and removed and disks to be formatted.

Nodal Degree-of-Freedom Menu

The nodal DOF menu appears after <Display to Disk> or <Trace to Disk> is selected if the <Node Info?> softkey in the [System]<Preferences> menu is set to "on." The nodal DOF menu allows entry of descriptive parameters relating to the nodal DOFs which will be saved with the file and available to external programs which convert the files to formats usable by modal analysis programs.

Node Information	
Reference Name	NODE1
Reference Num	1
Ref. Direction	+X
Response Name	
Response Name	NODE2
Response Num	2
Resp. Direction	+Y
Abort Save	<input type="button" value="=>"/>
Continue Save	<input type="button" value="=>"/>

Reference Name

Enter a descriptive name for the reference node. For a frequency response function, the reference node is the node where the stimulus is applied. The name may be up to six characters long.

The SR785 does not use the nodal degree-of-freedom information itself. The information is stored with the .78D file and is available for use by external programs which convert the SR785 files into formats suitable for modal analysis programs.

Command: RFNA (?) {s}

Reference Number

Enter the identification for the reference node. For a frequency response function, the reference node is the node where the stimulus is applied. The number may be any integer.

The SR785 does not use the nodal degree-of-freedom information itself. The information is stored with the .78D file and is available for use by external programs which convert the SR785 files into formats suitable for modal analysis programs.

Command: RFNU (?) {i}

Reference Direction

Enter the direction associated with the reference node, i.e. the direction of the stimulus. Direction can be specified either along the $\pm X$, Y , or Z axes for linear stimulus, or as $\pm \theta_x, \theta_y$, or θ_z direction for angular stimulus.

The SR785 does not use the nodal degree-of-freedom information itself. The information is stored with the .78D file and is available for use by external programs which convert the SR785 files into formats suitable for modal analysis programs.

Command: RFDR (?) {i}

Response Name

Enter a descriptive name for the response node. For a frequency response function, the response node is the node where the response is measured, e.g. the node where the accelerometer or other detector is placed.. The name may be up to six characters long.

The SR785 does not use the nodal degree-of-freedom information itself. The information is stored with the .78D file and is available for use by external programs which convert the SR785 files into formats suitable for modal analysis programs.

Command: RSNA (?) {s}

Response Number

Enter the identification for the reference node. For a frequency response function, the response node is the node where the response is measured, e.g. the node where the accelerometer or other detector is placed.. The number may be any integer.

The SR785 does not use the nodal degree-of-freedom information itself. The information is stored with the .78D file and is available for use by external programs which convert the SR785 files into formats suitable for modal analysis programs.

Command: RSNU (?) {i}

Response Direction

Enter the direction associated with the response node, i.e. the axis of the accelerometer or other measuring device. Direction can be specified either along the $\pm X$, Y , or Z axes for linear stimulus, or as $\pm \theta_x, \theta_y$, or θ_z for angular measurements.

The SR785 does not use the nodal degree-of-freedom information itself. The information is stored with the .78D file and is available for use by external programs which convert the SR785 files into formats suitable for modal analysis programs.

Command: RSDR (?) {i}

Abort Save

Press to abort the selected disk operation while in the nodal DOF information menu.

Continue Save

Press when finished entering nodal DOF information to continue the selected disk operation.

Recall Settings Menu

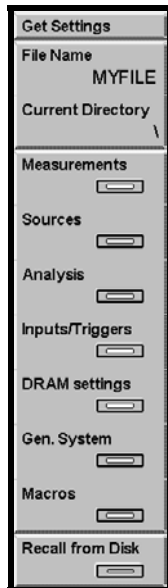

File Name

Enter the save and recall Current File Name.

Turn the knob to bring up the file catalog display listing all files in the Current Directory with the extension .78? (SR780 files). Press [Exp] to display all files in the directory (*.*). Choose a file name with the knob and press [Enter] to make it the Current File Name. This file name is used for saving and recalling displays, traces and settings. Remember, saving to this file will write over the existing file!

New file names are entered using the [Alt] key and the letters associated with each key. Press [Alt] again to return to normal keypad operation. DOS file name conventions must be followed. File names are 8 characters or less with an extension (.ext) of up to 3 characters. Default extensions are automatically supplied if no extension is specified. The default extensions should be used since the directory display assumes an extension appropriate for the current menu.

Command: FNAM (?) {s}
Command: FREE ?
Command: FXST ? s
Command: FRST ?
Command: FNXT ?

Current Directory

Enter the Current Disk Directory.

Turning the knob will bring up the directory tree display which lists all of the sub-directories on the disk. Choose a directory with the knob and press [Enter] to make it the Current Directory.

A directory may be entered using the [Alt] key and the letters associated with each key. Press [Alt] again to return to normal keypad operation. An error results if the entered directory does not exist.

New directories are created with <Make Directory>.

Command: FDIR (?) {s}

Measurements

Include the [Frequency], [Display Setup], [Display Options], [Marker], [Average], [Window], [User Math], [Waterfall] and [Capture] menu settings in the recall. This may invalidate current [Analysis] menu settings.

Command: SRCL i

Sources

Include the [Source] menu settings in the recall.

Command: SRCL i

Analysis

Include the [Analysis] menu settings in the recall. Do not recall Data Tables and Limits unless Measurements are also recalled. This is because the analysis parameters are defined for specific frequency Spans and Views.

Command: SRCL i

Inputs/Triggers

Include the [Input] and [Trigger] menu settings in the recall.

Command: SRCL i

DRAM settings

Include the memory allocation (Capture, Arbitrary Source, or Waterfall) settings in the recall.

Command: SRCL i

4-154 Recall Settings Menu

General System

Include the [System] and [Output] menu settings in the recall.

Command: SRCL i

Macros

Include stored macros in the recall.

Command: SRCL i

Recall from Disk

Recall the selected instrument settings from the Current File in the Current Directory. The recalled settings become effective immediately.

Command: SRCL i

Disk Buffers Menu

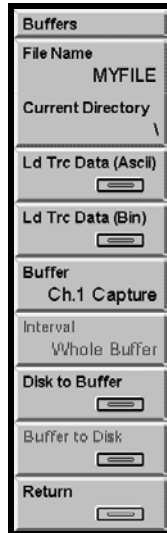

File Name

Enter the save and recall Current File Name.

Turn the knob to bring up the file catalog display listing all files in the Current Directory with the extension .78? (SR780 files). Press [Exp] to display all files in the directory (*.*). Choose a file name with the knob and press [Enter] to make it the Current File Name. This file name is used for saving and recalling displays, traces and settings. Remember, saving to this file will write over the existing file!

New file names are entered using the [Alt] key and the letters associated with each key. Press [Alt] again to return to normal keypad operation. DOS file name conventions must be followed. File names are 8 characters or less with an extension (.ext) of up to 3 characters. Default extensions are automatically supplied if no extension is specified. The default extensions should be used since the directory display assumes an extension appropriate for the current menu.

Command: FNAM (?) {s}
 Command: FREE ?
 Command: FXST ? s
 Command: FRST ?
 Command: FNXT ?

Current Directory

Enter the Current Disk Directory.

Turning the knob will bring up the directory tree display which lists all of the sub-directories on the disk. Choose a directory with the knob and press [Enter] to make it the Current Directory.

4-156 Disk Buffers Menu

A directory may be entered using the [Alt] key and the letters associated with each key. Press [Alt] again to return to normal keypad operation. An error results if the entered directory does not exist.

New directories are created with <Make Directory>.

Command: FDIR (?) {s}

Load Trace Data (ASCII)

Load ASCII data from the Current File in the Current Directory into an existing Trace. This is a way to import calibration data from a file into a trace. The trace can then be used in a user function to calibrate live measurements.

The target trace must already store data of the type and length to be loaded from disk. The file only contains data points, no measurement information is recalled. The recalled data simply takes the place of the stored trace data and assumes the trace's measurement parameters (Measurement, Averaging, Window, Frequency span) and length.

The ASCII file consists of N pairs of ASCII floating point values. Each pair of values represents the real and imaginary parts of a single complex data point. Thus, the file contains 2N floating point numbers. The values are linearly scaled (usually with units of Vpk).

The first value in the file is N, followed by the real part of the first point, then the imaginary part of the first point, etc. Each value is delimited by a comma, white space, tab or carriage return. Traces which are entirely real should store 0.0 as the imaginary part of every point.

The value of N depends upon the type and length of the target trace.

<u>Trace Type</u>	<u>N</u>
FFT, Coherence, CrossSpec, Transfer Function	
100 FFT lines	128 (1st 101 points displayed)
200 FFT lines	256 (1st 201 points displayed)
400 FFT lines	512 (1st 401 points displayed)
800 FFT lines	1024 (1st 801 points displayed)
Correlations	
Uniform window	2.56 times number of FFT lines (imaginary parts all zero)
T/2 window	1.28 times number of FFT lines (imaginary parts all zero)
Time Records	
Baseband Time	2.56 times number of FFT lines (all points are real, the imaginary parts should all be zero)
Non-baseband Time	1.28 times number of FFT lines (all points are complex)

Octave	number of displayed bins + 1 (the power bin is the last point) (all points are real, the imaginary parts should all be zero)
Swept Sine	Number of points in the sweep

For example, the ASCII file for a 400 line FFT might be

```
512
0.000, 0.500
1.000, 1.500
2.000, 2.500
...
511.000, 511.500
```

where (0.000, 0.500) is the first complex data point and (511.000, 511.500) is the 512th data point.

To read this file into a trace, a 400 line FFT must first be stored in the trace. This can be done using <Display to Trace> or <Disk to Trace>. Loading the ASCII file into the trace then replaces the trace data with the data from the disk file.

Command: TASC ? i, n

Load Trace Data (binary)

Load binary data from the Current File in the Current Directory into a Trace. This is a way to import calibration data from a file into a trace. The trace can then be used in a user function to calibrate live measurements.

The target trace must already store data of the type and length to be loaded from disk. The file only contains data points, no measurement information is recalled. The recalled data simply takes the place of the stored trace data and assumes the trace's measurement parameters (Measurement, Averaging, Window, Frequency span) and length.

The binary file contains N complex points. Each complex data point is two floating point numbers, representing the real and imaginary parts. Thus, the file contains 2N floating point numbers. The values are linearly scaled (usually with units of Vpk).

The first value in the file is N (4-byte long integer), followed by the real part of the first point (4-byte IEEE float), then the imaginary part of the first point (4 byte IEEE float), etc. There are no delimiters in a binary file. The data is packed. Traces which are entirely real should store the value 0.0 as the imaginary part of every point.

The binary file has the following form where [?] represents a single byte.

```
[N lsb] [N] [N] [N msb] [X0 lsb] [X0] [X0] [X0 msb] [Y0 lsb] [Y0] [Y0] [Y0 msb]
[X1 lsb] [X1] [X1] [X1 msb] [Y1 lsb] ... [Y(N-1) msb]
```

4-158 Disk Buffers Menu

where (X0, Y0) is the first complex data point and (XN-1, YN-1) is the Nth data point. Each value is 4-byte IEEE float.

The value of N depends upon the type and length of the target trace. See <Load Trace Data (Ascii)> for more.

Command: TLOD ? i, n

Buffer

Choose which data buffer (Ch1 capture, Ch2 capture, Arbitrary Waveform or Waterfall) to save to or load from disk. Buffers which have no allocation may not be chosen. Only the capture buffers specified by <Capture Channels> may be chosen.

Ch1 capture and Ch2 capture are saved and recalled separately. Both can be recalled into a buffer configured for Ch1+Ch2capture channels.

The waterfall buffers for both displays are saved together (all stored waterfall records for both displays are saved). If one display has waterfall storage off, then no data is saved for that display.

Capture and Arbitrary files are compatible. Data saved from a capture buffer can be loaded into the arbitrary waveform buffer (and vice versa).

Interval

Choose to save the entire data buffer or only the playback portion (Capture or Arbitrary Waveform). All stored waterfall records for both displays are saved.

This only affects the saving of data to disk. When a buffer is loaded from disk, the buffer is configured to be exactly the length of the recalled data.

Disk to Buffer

Load binary data from the Current File in the Current Directory into the selected data buffer. This function only recalls files made using <Buffer to Disk>. The selected buffer (Capture, Arbitrary Waveform or Waterfall) must have sufficient memory allocated before loading from disk.

Load Arbitrary Waveform

A saved Arbitrary or Capture file may be loaded into the Arbitrary Waveform buffer. The Arb. Src. Length will be set to the length of the disk data.

Load A Capture Buffer

A saved Arbitrary or Capture file may be loaded into a Capture buffer.

If the disk data has the same Capture Length and Sampling Rate as shown in the current [Capture] menu, the data is simply loaded into the selected channel's buffer. In the case

of Ch1+Ch2 capture, loading one channel does not disturb the contents of the other channel's buffer.

If either the length or sampling rate is different from the current [Capture] menu, they are changed to the length and sampling rate of the disk data. In the case of Ch1+Ch2 capture, loading Ch1 (Ch2) capture will zero the Ch2 (Ch1) capture buffer if the capture length or sampling rate is changed by this operation.

To recall both capture channels, configure <Capture Channels> for Ch1+Ch2. Both files must contain the same length buffers with the same sampling rate. Use <Buffer> to choose either Ch1 or Ch2 and load the appropriate disk file to the buffer. This will set the capture length and sampling rate according to the recalled disk file. Then use <Buffer> to choose the other channel and load the other disk file to the buffer. Since the existing Capture Length and Sampling Rate are already compatible, this operation does not zero the first capture buffer.

Load the Waterfall Buffer

A saved Waterfall file may be loaded into the Waterfall buffer.

Loading a Waterfall file loads data into the waterfall buffer *and* recalls the measurement parameters which were in effect when the waterfall buffer was saved. The recalled parameters include items in the [Frequency], [Display Setup], [Display Options], [Average], [Window], [User Math], and [Waterfall] menus.

If the file contains records from both displays, data is recalled for both displays. The Waterfall Storage is set to Recalled. Recalled simply means that the waterfall displays contain data which did not come from the two inputs but rather from disk.

Recalled waterfall data is *not* protected in any way! The recalled waterfall data behaves as if the measurement was paused. Pressing [Start/Reset] or changing any measurement parameter which normally causes the waterfall buffer to reset and take new data will *destroy the recalled data!* The recalled data is available for viewing and hardcopy only.

Command: APUT ? i

Command: CPUT ? i, j

Command: WPUT ?

Command: TPUT ? i

Buffer to Disk

Save binary data from the selected data buffer to the Current File in the Current Directory. Use <Interval> to select the playback portion or entire buffer.

File Size

All data points are stored in binary as 4-byte IEEE floats. To estimate the disk space required to save a buffer, compute the number of data points and multiply by 4 bytes. In addition, there is a small header containing measurement data.

Capture and Arbitrary Waveform are both inherently real data (baseband). Thus the number of data points in the buffer is simply the length of the buffer in points (or the

4-160 Disk Buffers Menu

playback portion if desired). To save a 100k capture buffer requires 100k data points or 400k bytes.

Waterfall buffers are more complicated. The measurement parameters determine the number of points in a single record. See <Load Trace Data (Ascii)> for a table of lengths. Each record is complex (2 floating point values for each data point). Each waterfall buffer contains a number of records. For example, if both displays have stored 250 400 line FFT's in the waterfall buffer, the disk space required to save the entire buffer is

$512 \text{ (pts in FFT)} \times 2 \text{ (floats per complex pt)} \times 250 \text{ (stored records)} \times 2 \text{ (both displays)} = 512,000 \text{ bytes.}$

If more space is required than is available on disk, the buffer save will require multiple disks. At each disk prompt, insert a formatted disk. Remember to label the disks in sequence! The file **MUST** be recalled in the correct disk order.

Command: AGET ? i

Command: CGET ? i

Command: WGET ?

Command: TGET ? i

Disk Upkeep Menu

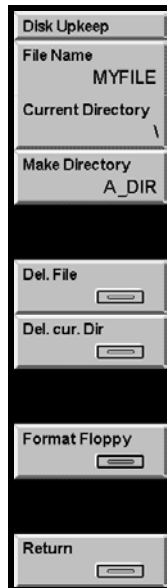

File Name

Enter the File Name for Disk Upkeep. Keeping this file name separate from the save/recall file name makes it harder to erase a file accidentally.

Turn the knob to bring up the file catalog display listing all files in the Current Directory with the extension .78? (SR780 files). Press [Exp] to display all files in the directory (*.*). Choose a file name with the knob and press [Enter] to make it the Upkeep File Name. This file may be erased with <Del File>.

New file names are entered using the [Alt] key and the letters associated with each key. Press [Alt] again to return to normal keypad operation. DOS file name conventions must be followed. File names are 8 characters or less with an extension (.ext) of up to 3 characters.

Command: DNAM (?) {s}

Current Directory

Enter the Current Disk Directory.

Turning the knob will bring up the directory tree display which lists all of the sub-directories on the disk. Choose a directory with the knob and press [Enter] to make it the Current Directory.

A directory may be entered using the [Alt] key and the letters associated with each key. Press [Alt] again to return to normal keypad operation. An error results if the entered directory does not exist.

4-162 Disk Upkeep Menu

New directories are created with <Make Directory>.

Command: FDIR (?) {s}

Make Directory

Make a new directory on the disk. Enter a directory name with the [Alt] key. The new directory will be created in the Current Directory.

Command: MDIR s

Del File

Delete the Disk Upkeep File from the Current Directory. Make sure that the file and directory are correct before pressing this key!

Command: DELF

Del Cur Dir

Delete the Current Directory from disk. Make sure that the directory is correct before pressing this key! The directory must be empty before it can be deleted.

Command: DELD

Format Floppy

Format the disk. The disk capacity is 720k for DS/DD disks and 1.44M for DS/HD disks. A disk must be formatted before files can be stored on it. Formatting a disk involves erasing all information from the disk and rewriting the directory. **Formatting a disk destroys all data presently on disk!**

Output Menu

The Output menu prints or plots the screen display. Printer and plotter configurations are set in this menu.



Hard Copy Button

Assign either Bitmap/Print, Vector/Plotter ASCII Dump to the [Print Screen] hardkey.

The [Print Screen] hardkey allows you to print, plot or dump the screen from any menu.

Command: POUT

Bitmap/Print

Prints the screen using the selected Bitmap/Printer and Bitmap Area to the selected Destination (Interface or Disk).

Other front panel operations are disabled until printing is completed. Pressing backspace will abort the operation.

Command: PRNT

Vector/Plot

Plot the screen using the selected Vector Plotter to the selected Destination (Interface or Disk).

Other front panel operations are disabled until plotting is completed. Pressing backspace will abort the operation.

Command: PLOT

4-164 Output Menu

ASCII Dump

Dump the data in the active display in ASCII format to the selected Destination (Interface or Disk). The data is written f,y,x[cr] with the data for each point on a single line. f is the frequency or time value, y is the y-axis value and x is the x-axis value (if necessary).

Other front panel operations are disabled until the dump is completed. Pressing backspace will abort the operation.

Command: DUMP

Bitmap/Printer

Select the Bitmap/Printer type for the Bitmap/Print operation [Epson FX, HP PCL, HP Small PCL, PCX 2 bit, GIF, PCX 8 bit].

Epson FX is used for Epson compatible dot matrix graphics printers.

HP PCL and HP Small PCL are used for HP LaserJet or InkJet compatible printers. HP PCL is a full page printout and HP Small PCL is half page.

The PCX and GIF types are bit mapped file formats. Choose one of these if you want to print to a disk file and import the image into a PC application.

The Destination for all Bitmap/Printer types can be either an on-line Interface or a Disk file.

Command: PRTP (?) {i}

Bitmap Area

Select the portion of the screen for the Bitmap/Print operation [Graphs, Menu, Indicators, All]. Vector/Plot only plots the displayed graphs.

Graphs prints the graph areas. This is a single or dual graph.

Menu prints the menu of softkeys.

Indicators prints the status indicators at the top of the screen.

All prints the entire screen image including the menu softkeys and status area.

Command: PSCR (?) {i}

Vector/Plotter

Select the Vector/Plotter type for the Vector/Plot operation [HPGL, Postscript]. Vector/Plot only plots the displayed graphs.

HPGL is used for HPGL compatible plotters.

Postscript is used for Postscript compatible plotters or printers. Postscript output to a disk file is a convenient way to import the screen plot to a PC application.

The Destination for all Plotter Types can be either an on-line Interface or a Disk file.

Command: PLTP (?) {i}

Destination

This softkey selects the Print, Plot or ASCII Dump Destination [Disk File, Centronics, Serial, GPIB].

Choose Disk File to output to a disk file. All Bitmap/Printer and Vector/Plotter types can save to Disk File. This is convenient for using a printer or plotter which is not connected to this unit or to import the screen image into a PC application. Files are written to the Current Directory specified in the [Disk] menu. Files are named SCRNXXXX.EXT where XXXX is a 4 digit number which automatically increments starting at the File Start Number. The .EXT extensions are

.TXT	ASCII Dump
.EFX	Epson
.PCL	HP Laser
.GIF	GIF
.PCX	PCX
.HPG	HPGL
.EPS	Postscript

Centronics selects the parallel printer interface. Most dot matrix printers use this.

Serial selects the RS-232 serial interface. Some plotters and printers use this.

GPIB selects the IEEE-488 interface. Most HPGL plotters use this.

Command: PDST (?) {i}

GPIB Control

Choose the GPIB Controller [Host or SR780].

Choose SR780 if there are no other controllers attached to the GPIB interface. This is typically the case where only a plotter is attached to the SR780.

Choose Host if there is host computer which is in control. This is the case where both the SR780 and the plotter are controlled by a host computer. The host is responsible for issuing the PLOT command to the SR780, and then making the plotter a listener and the SR780 a talker. The plotter commands will then be transferred from the SR780 to the plotter. The host can periodically untalk the SR780 and serial poll the SR780 (via the Instrument Status) to determine when the plot is finished.

Command: PCIC (?) {i}

4-166 Output Menu

GPIB Address

Enter the GPIB Address for a GPIB plotter or printer [0..30].

If an HPGL plotter is used with the GPIB interface, this GPIB Address must agree with the actual address of the plotter.

Command: PLTA (?) {i}

Edit A Note

Select a Note to edit [0..7] and press [Enter] to display the Edit Note menu. A Note is a text annotation within a display graph. Notes are visible only within this menu and may be printed or plotted with the graph using [Print Screen].

Press <Return> for the [Output] menu.

Command: NOTE i, j {, k, l, m, s}

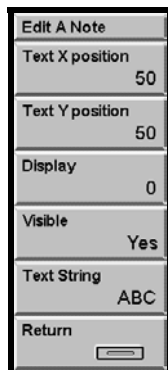

Text X position	50
Text Y position	50
Display	0
Visible	Yes
Text String	ABC
Return	<input type="button" value="Return"/>

Text X Position

Adjust the horizontal position of the Note with the knob.

Command: NOTE i, j {, k, l, m, s}

Text Y Position

Adjust the vertical position of the Note with the knob.

Command: NOTE i, j {, k, l, m, s}

Display

Select which display the Note appears in [0=DisplayA, 1=DisplayB].

Command: NOTE i, j {, k, l, m, s}

Visible

Make the Note visible [Yes (visible), No (invisible)].

Command: NOTE i, j {, k, l, m, s}

Text String

Enter the Note text. Use the [Alt] key to enter the note text.

Command: NOTE i, j {, k, l, m, s}

File Start Number

Set the Starting File Number for printing, plotting or dumping to Disk [XXXX (up to 4 digit integer)].

All Bitmap/Printer and Vector/Plotter types can save to Disk. This is convenient for using a printer which is not connected to this unit or to import the screen image into a PC application. Files are written to the Current Directory specified in the [Disk] menu. Files are named SCRNX.XXX.EXT where XXXX is a 4 digit number which automatically increments starting at the File Start Number.

Command: PFIL (?) {i}

Colors

Display the Hardcopy Colors menu. Press <Return> or [Output] for the main [Output] menu .

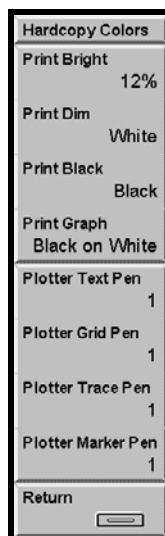
**Print Color Selections**

Printing is a bit mapped operation. Different areas of the screen can be printed with different print densities giving a range of gray between black and white (white paper).

4-168 Output Menu

These colors only affect Epson (FX and 24 pin) and HP (Laser and Laser small) printer types.

Print Bright

Select the print density of highlighted areas (e.g. active display marker display) [White (none on white paper), 6%, 12%, 25%, 50%, (100%) Black].

Command: PBRI (?) {i}

Print Dim

Select the print density of the normal background (e.g. X and Y axis graph labels) [White (none on white paper),r 6%, 12%, 25%, 50%, (100%) Black].

Command: PDIM (?) {i}

Print Black

Select the print density for black text [Black, White (none on white paper)]. Use White only if the Print Bright and Print Dim are both black or gray.

Command: PBLK (?) {i}

Print Graph

Select the graph print mode [Black on White, White on Black]. The graph is normally printed as Black (data and grid) on White (background). This uses the least printer ink. Choosing White (data and grid) on Black (background) prints a large black area on the paper.

Command: PGRF (?) {i}

Plot Color Selections

Many plotters have a multipen carousel. In this case, different items on the graph may be plotted using different color pens. When using a single pen plotter, all items are plotted using the one pen regardless of the pen definitions. Only the graph display areas are plotted.

Plotter Text Pen

Assign a plotter pen number to the text labels on the graphs [1 to 8].

Command: PLTX (?) {i}

Plotter Grid Pen

Assign a plotter pen number to the graph grid [1 to 8].

Command: PLGD (?) {i}

Plotter Trace Pen

Assign a plotter pen number to the graph data trace [1 to 8].

Command: PLTR (?) {i}

Plotter Marker Pen

Assign a plotter pen number to the graph marker [1 to 8]. Turn the marker off to avoid plotting it.

Command: PLMK (?) {i}

System Menu

The System menu configures the interfaces, clock/calendar and system preferences and edits recorded macros. The Diagnostics menu accesses various hardware tests.

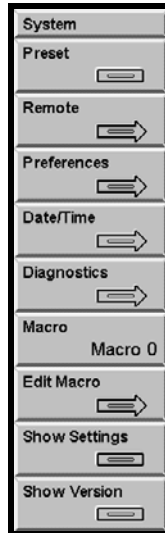

Preset

Reset the instrument to the default settings. Only the remote interface settings are not changed. All stored data are lost.

This function requires pressing the [Enter] key to confirm.

To completely reset the instrument (including remote interface settings), power the unit on with the backspace key held down.

Command: *RST

Remote

Display the [System] <Remote> interface menu. Remote interface parameters should not be altered while the computer interface is active. Press <Return> or [System] for the [System] menu.

Preferences

Display the [System] <Preferences> menu. Press <Return> or [System] for the [System] menu.

4-172 System Menu

Date/Time

Display the [System] <Date/Time> menu. Press <Return> or [System] for the [System] menu.

Diagnostics

Display the [System] <Diagnostics> test menu. Press <Return> or [System] for the [System] menu.

Macro

Use the knob to pick one of the ten Macros to edit and press [Enter]. All macros may be edited including those which have not been recorded.

See 'Macros' in Chapter 3 for more.

Edit Macro

Display the Edit Macro menu to edit the selected macro. Press <Cancel> to exit back to the main [System] menu.

It is generally easier to record a macro than it is to enter it in this menu. Use this menu to edit existing macros. See 'Macros' in Chapter 3 for more.

To enter a macro string, enter Menu, Function, Control and Number keys by simply pressing the desired key (these keys do not have their normal effect in this menu) . Use <Special Keys> and the knob to select <Softkeys> and [Enter]. [-] (Backspace) deletes the term before the cursor.

To edit a macro string, use <Macro String> and the knob to move the flashing cursor within the string. <Delete> will delete the highlighted term. Menu, Function, Control and Number keys and <Special Keys> will either insert or replace at the cursor. Use <Insert/Replace> to switch between insert and replace mode. <Clear Macro> will delete the entire string.

To increase (CW) or decrease (CCW) a knob event, use <Inc. Knob Count> and <Dec. Knob Count>.

<Cancel> will discard any changes made in this menu and exit this menu.

<Enter Macro> will enter the new macro and exit this menu. Pressing [Enter] while the cursor is in the macro string display also enters the macro and exits this menu.

Show Settings

Show the instrument setup. This key enters the Help system and displays the measurement setup and system settings. Press [0] to exit Help.

Show Version

Show the power on screen. This screen shows the version number as well as the results of the power on tests. The size of the installed data memory is also displayed (2 Ms, 4 Ms or 8Ms).

System Remote Menu

Remote
Output To GPIB
GPIB Address 10
Override REM? Yes
Baud Rate 9600 bd
Word Length 8 bits
Parity None
View Qs <input type="checkbox"/>
Return <input type="checkbox"/>

Output To

Select the Output Interface [RS232, GPIB]. All interface query responses are directed to the selected Output Interface regardless of which interface received the query. Use the OUTX command to select the correct interface at the beginning of every program.

Command: OUTX (?) {i}

GPIB Address

Enter or adjust the instrument GPIB Address [0..30].

Override REM?

Select the Override Remote mode [Yes, No]. In general, every GPIB interface command will put the unit into the REMOTE state with the front panel locked out. To defeat this feature, set this entry to Yes. In this mode, the front panel is not locked out when the unit is in the REMOTE state.

To return to from REMOTE to LOCAL (front panel enabled), press [Help/Local].

Command: OVRM (?) {i}

Baud Rate

Select the RS232 (Serial) interface Baud Rate [300, 1200, 2400, 4800, 9600, 19.2k]. Most PC's use 9600 as a default.

Word Length

Select the RS232 (Serial) interface Word Length [7 bits, 8 bits]. 8 bits is standard.

Parity

Select the RS232 (Serial) interface Parity [None, Even, Odd]. None is standard.

View Qs

Display the Remote Interface Queue. The SR780 buffers the characters which are received or transmitted over the interface. The Queue display shows the interface history. The Queue display may slow down communications and should be displayed only when testing or debugging a host program.

The upper half of the screen is the Receive Queue. These are the most recent characters which have been received by the SR780. Commands which have already been executed are shown in normal text. Commands which have not yet been executed are shown with a bright background. Command errors are shown in inverse text.

The lower half of the screen is the Transmit Queue. These are the most recent characters which have been placed in output buffer. Characters which have already been sent over the interface are shown in normal text. Characters which are waiting to be sent are shown with a bright background.

Press any key to exit from this display.

System Preferences Menu

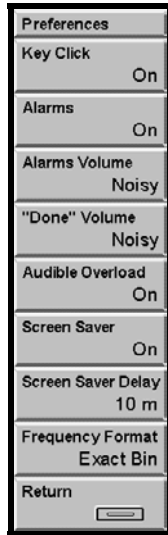

Key Click

Turn the Key Click on or off.

Command: KCLK (?) {i}

Alarms

Turn the system Alarm messages On or Off.

Command: ALRM (?) {i}

Alarms Volume

If Alarms Volume is set to Quiet, alarm messages have no accompanying sound. If Alarms are set to Noisy, alarm messages are accompanied by an audible alarm.

Set system Alarms to Off for no alarm message at all.

Command: ALRT (?) {i}

Done Volume

If Done Volume is set to Noisy, an audible alarm is sounded when a measurement is done or completed. For example, when linear averaging is complete, an alarm is sounded.

Command: ADON (?) {i}

Audible Overload

If Audible Overload is set to On, an audible alarm is sounded whenever an input is overloaded.

Command: AOVL (?) {i}

Screen Saver

Turns the Screen Saver On or Off. Using the Screen Saver extends the life of the video display and prevents screen 'burn'.

When the Screen Saver is On and the Screen Saver Delay passes without a key press, knob turn or interface command, the screen will be blanked and random patterns are displayed. Press any key to return the screen to normal.

Command: \SAVR (?) {i}

Screen Saver Delay

Set the Screen Saver Delay in minutes [1..59].

When the Screen Saver is on and the Screen Saver Delay passes without a key press, knob turn or interface command, the screen will be blanked and random patterns displayed. Press any key to return the screen to normal.

Command: SDLY (?) {i}

Frequency Format

Select the Frequency Format [Exact Bin, Rounded].

Exact Bin displays frequencies exactly. This can make the frequency display have many more digits than required to distinguish adjacent frequency bins. However, this format is useful when determining the exact frequency of a bin.

Rounded shortens the frequency displays to show only those digits which are required to distinguish adjacent frequency bins. This simplifies and shortens the frequency displays but does not show the exact frequency of a bin.

For example, for a 400 line FFT on 100.0 kHz base with a span of 97.66 Hz, the first frequency bin is shown as 244.140625 mHz (Exact Bin) or 244.1 mHz (Rounded). The second bin is 488.28125 mHz (Exact Bin) and 488.3 mHz (Rounded).

Command: FFMT (?) {i}

Node Info Prompt

Turns the node information prompt when saving files on or off.

4-178 System Preferences Menu

Modal analysis programs require that a given spectrum, cross spectrum, or frequency response function (transfer function) be associated with information regarding the nodal degrees of freedom (DOF). When Node Info Prompt is set on, the SR780 allows entry of DOF parameters when saving data using Trace to Disk or Display to Disk. When the “Trace to Disk” or “Display to Disk” is initiated using a remote command, the node info prompt will not be displayed, however the information entered in the “Node Info” menu will still be saved with the disk file as long as the “Node Info Prompt” softkey is on.

The nodal DOF information is saved with the disk file and is used when translating SR780 files to Universal File Format (UFF) and other file formats used by popular modal analysis programs.

Command: SVNI (?) {i}

System Date/Time Menu

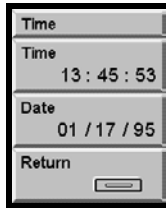

Time

Set the System Time [hh:mm:ss]. The System Time is entered as hours:minutes:seconds and all entries are 6 digits. 24 hour format is used. [Enter] sets the new time or press this softkey again to abort the entry.

Command: TIME (?) {i}

Date

Set the System Date [mm:dd:yy]. The System Date is entered as month:day:year and all entries are 6 digits. [Enter] sets the new date or press this softkey again to abort the entry.

Command: DATE (?) {i}

System Diagnostics Menu

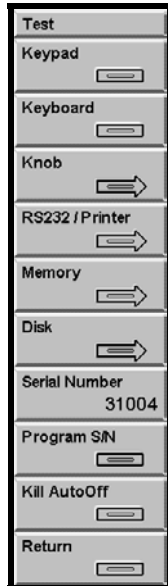

Keypad Test

Display the Keypad Test screen. The test screen is a map of the keypad. Press each key until all keys are marked. When all of the keys are marked, the test is completed successfully. Turn the knob to abort this test and return to the <Diagnostics> menu.

Keyboard Test

Display the Keyboard Test screen. Characters typed on an attached PC keyboard (PC/XT or 8088 mode required) are displayed on the test screen. If the displayed characters are accurate, then the keyboard interface is functioning correctly. If not, check that the keyboard is in the correct mode. Many keyboards have a switch on the bottom to select PC/XT (8088) or AT (80286) mode. Turn the knob to abort this test and return to the <Diagnostics> menu.

Knob Test

Display the Knob Test screen. A circle with a marker is displayed. Select one of the 4 speeds displayed in the menu [Snail, Human Baby, Adult, Lunatic]. Turning the knob will move the marker around the circle, verifying knob action and direction. Press <Return> for the <Diagnostics> menu.

RS232/Printer Test

Display the RS232/Printer Test screen.

A loop back adapter is required to complete the RS232 test. This adapter is simply a mating connector with pins 2 and 3 connected so characters transmitted by the interface will be received as well. Press <Begin> to start the test. Press <Return> for the <Diagnostics> menu.

String to RS232

Send an ASCII test string to a serial printer connected to the RS232 port.

String to Printer

Send an ASCII test string to a parallel printer connected to the Printer port.

Memory Test

Display the <Memory Test> menu. Select a test and press <Begin>.

System RAM

Display the System RAM Test screen. Press <Begin> to test the main CPU program RAM. Press <Return> for the <Memory Test> menu.

System ROM

Display the System ROM Test screen. Press <Begin> to test the main CPU program ROM. Press <Return> for the <Memory Test> menu.

Video RAM

Display the Video Ram Test screen. Press <Begin> to test the video display memory. Press <Return> for the <Memory Test> menu.

Help ROM

Display the Help ROM Test screen. Press <Begin> to test the help system memory. Press <Return> for the <Memory Test> menu.

Disk Test

Display the Disk Drive Test screen.

Continuing with this test will destroy any data on the disk currently in the drive!

Remove the data disk and insert a scratch disk. This test will check the controller, format the disk and perform a read/write check on the disk. The entire test takes about 2 minutes. Press <Begin> to start the test. When the test reaches the Disk Changed Sensor Out phase, remove the disk and then insert it again.

Press <Return> for the <Diagnostics> menu.

4-182 System Diagnostics Menu

Serial Number

Reset the internally stored serial number after replacing the DSP board. The serial number which is reported on the power-on screen and in the GPIB identification string is stored in the calibration ROM on the DSP board.

Do not use this function unless the DSP board has been replaced!

After replacing the DSP board, enter the unit serial number (shown on the rear panel) and use <Program S/N> to store the serial number permanently.

Press <Return> for the <Diagnostics> menu.

Program S/N

Reset the internally stored serial number after replacing the DSP board. The serial number which is reported on the power-on screen and in the GPIB identification string is stored in the calibration ROM on the DSP board.

Do not use this function unless the DSP board has been replaced!

After replacing the DSP board, use <Serial Number> to enter the unit serial number (shown on the rear panel) and use <Program S/N> to store the serial number permanently.

Press <Return> for the <Diagnostics> menu.

Kill AutoOff

Clear the internal input offset calibrations and disable Auto Offset.

Do not use this function unless you are making input offset or CMR adjustments to an analog input board. See the Service Manual for more information.

The unit must be turned off and back on after using this function to restore the input calibrations!

Edit Macro Menu

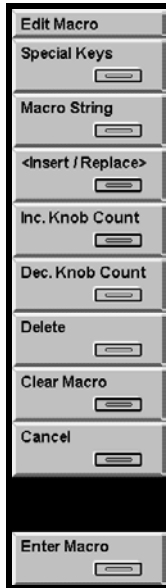

Special Keys

Use the knob to pick a <Softkey> or other special key from the display and press [Enter] to place it in the macro string at the cursor location.

To place [Enter] into the macro string, use <Special Keys>. Pressing the [Enter] key while the cursor is in the macro string display enters the macro and exits this menu.

To place [-] (backspace) into the macro string, use <Special Keys>. The [-] key deletes the term before the cursor.

Macro String

Move the cursor to the macro string window at the top of the screen. Use the knob to move the highlighted cursor within the string. <Delete> will delete the highlighted term. Menu, Function, Control and Number keys and <Special Keys> will either insert or replace at the cursor. Use <Insert/Replace> to switch between insert and replace mode.

[-] (Backspace) deletes the term before the cursor.

Insert/Replace

Toggle between insert and replace mode while editing a macro string.

If editing in insert mode, 'Ins' appears in the upper right corner of the edit window. If editing in replace mode, 'Rep' appears.

4-184 System Diagnostics Menu

When editing a macro string, Menu, Function, Control and Number keys and <Special Keys> will insert or replace before the cursor.

Inc. Knob Count

To edit a knob event, move the cursor to the macro string window at the top of the screen and move to the desired knob event (displayed as <Knob n>). <Inc. Knob Count> will increase the knob count by 1 which is the same as rotating clockwise one choice in a parameter list.

Dec. Knob Count

To edit a knob event, move the cursor to the macro string window at the top of the screen and move to the desired knob event (displayed as <Knob n>). <Dec. Knob Count> will decrease the knob count by 1 which is the same as rotating counterclockwise one choice in a parameter list.

Delete

Delete the highlighted term in a macro string. To move the cursor in a macro string, use <Macro String> and the knob.

Clear Macro

Clear the entire macro string.

Cancel

Discard any changes made in this menu and exit this menu.

Enter Macro

Enter the displayed string as the new macro and exit this menu. Use [Play Macro] to playback the macro string.

Chapter 5

Remote Programming

In This Chapter

Index of Commands	5-2	User Math Commands	5-61
Alphabetical List of Commands	5-11	Window Commands (FFT)	5-63
Introduction	5-19	Waterfall Commands	5-65
Communicating With GPIB	5-19	Capture Commands	5-68
Communicating With RS232	5-19	Memory Allocation Commands	5-69
Screen Indicators And Queues	5-19	Data Table Commands	5-70
Command Format	5-20	Limit Test Commands	5-72
Command Synchronization	5-20	Marker Statistics Commands	5-74
Data Synchronization	5-21	Exceedance Statistics Commands	5-75
Command Context Errors	5-22	Disk Commands	5-76
Example Program	5-22	Output Commands	5-79
Command Syntax	5-23	System Commands	5-82
Help	5-23	Front Panel Commands	5-84
Things to Remember!	5-24	Data Transfer Commands	5-89
Output Interface (RS232 or GPIB)	5-24	Interface Commands	5-101
Active Display and Linking	5-24	Nodal DOF Commands	5-102
Command Context Errors	5-24	Status Reporting Commands	5-104
Frequency Commands (FFT)	5-25	Status Word Definitions	5-108
Frequency Commands (Octave)	5-27	Example Program	5-113
Frequency Commands (Swept Sine)	5-29		
Display Setup Commands	5-31		
Display Options Commands	5-35		
Marker Commands	5-37		
Marker Commands (Normal)	5-39		
Marker Commands (Harmonic)	5-41		
Marker Commands (Sideband)	5-42		
Marker Commands (Band)	5-43		
Source Commands	5-44		
Sine Source Commands	5-45		
Chirp Source Commands	5-46		
Noise Source Commands	5-47		
Arbitrary Source Commands	5-48		
Swept Sine Source Commands	5-49		
Input Commands	5-51		
Input Playback Commands	5-54		
Trigger Commands	5-55		
Average Commands (FFT)	5-56		
Average Commands (Octave)	5-58		
Average Commands (Swept Sine)	5-60		

Index of Commands

Variables

d	display (0=DisplayA, 1=DisplayB, 2=Both)
i, j, k, l, m	integers
x, y	real numbers
f	frequency in Hz
s	text string

Frequency (FFT Measurement Group)

FSPN (?) d {, f}	5-25	FFT Frequency Span
FLIN (?) d {, i}	5-25	FFT Resolution
FBAS (?) d {, i}	5-25	FFT Base Frequency
FSTR (?) d {, f}	5-25	FFT Start Frequency
FCTR (?) d {, f}	5-25	FFT Center Frequency
FEND (?) d {, f}	5-26	FFT End Frequency
UNST d	5-26	Unsettle Measurement

Frequency (Octave Measurement Group)

OHIB (?) d {, f}	5-27	Octave Highest Band
OLOB (?) d {, f}	5-27	Octave Lowest Band
ORES (?) d {, i}	5-27	Octave Resolution
OCHN (?) {i}	5-27	Octave Channels
UNST d	5-27	Unsettle Measurement

Frequency (Swept Sine Measurement Group)

SSTR (?) d {, f}	5-29	Swept Sine Start Frequency
SSTP (?) d {, f}	5-29	Swept Sine Stop Frequency
SSFR ?	5-29	Swept Sine Progress?
SRPT (?) d {, i}	5-29	Swept Sine Repeat Mode
SSTY (?) d {, i}	5-29	Swept Sine Sweep Type
SARS (?) d {, i}	5-29	Swept Sine Auto Resolution
SNPS (?) d {, i}	5-30	Swept Sine Number of Points
SSKP (?) d {, i}	5-30	Swept Sine Max Step Size
SFST (?) d {, x}	5-30	Swept Sine Faster Threshold
SSLO (?) d {, x}	5-30	Swept Sine Slower Threshold

Display Setup

MGRP (?) d {, i}	5-31	Measurement Group
MEAS (?) d {, i}	5-31	Display Measurement
VIEW (?) d {, i}	5-32	Display View
UNIT (?) d {, i}	5-33	Display Units
YMAX (?) d {, x}	5-33	Y Maximum
YMID (?) d {, x}	5-33	Y Midpoint
YMIN (?) d {, x}	5-33	Y Minimum
YDIV (?) d {, x}	5-34	Y/Division
XCEN (?) d {, x}	5-34	X Center (Polar)
XDIV (?) d {, x}	5-34	X/Division (Polar)
YCEN (?) d {, x}	5-34	Y Center (Polar)
Y2DV (?) d {, x}	5-34	Y/Division (Polar)
XPAN (?) d {, i}	5-34	X Pan
XZOM (?) d {, i}	5-34	X Zoom

Display Options

DISP (?) d {, i}	5-35	Display Update Mode
DFMT (?) {i}	5-35	Display Format
ACTD (?) i	5-35	Active Display
XAXS (?) d {, i}	5-35	X Axis Scale Type
GRID (?) d {, i}	5-35	Grid On/Off
GDIV (?) d {, i}	5-35	Number of Grid Divisions
PSDU (?) d {, i}	5-35	PSD Units On/Off
TDRC (?) d {, i}	5-36	Transducer Unit Convert
DBMR (?) {x}	5-36	dBm Reference Impedance
PHSL (?) d {, x}	5-36	Phase Suppress Threshold
DDXW (?) d {, x}	5-36	d/dx Window

Marker

MRKR (?) d {, i}	5-37	Marker Tracking
MKMD (?) d {, i}	5-37	Marker Mode
MBIN d, i	5-37	Marker Move to bin i
MWFL d, i	5-37	Marker Move Waterfall to record i
MRKX ? d	5-37	Query the Marker X Position
MRKB ? d	5-37	Query the Marker Bin
MRKY ? d	5-37	Query the Marker Y Position
MRKZ ? d	5-38	Marker Z Read
MKMX d	5-38	Move the Marker to the Maximum
MKMN d	5-38	Move the Marker to the Minimum
MKCN d	5-38	Center of FFT Span to Marker

Normal Marker

MSEK (?) d {, i}	5-39	Normal Marker Seeks Mode
MWID (?) d {, i}	5-39	Normal Marker Width
MREL (?) d {, i}	5-39	Normal Marker Relative Mode
MROX (?) d {, x}	5-39	Normal Marker X Offset
MROY (?) d {, x}	5-39	Normal Marker Y Offset
MXRL (?) d {, i}	5-39	Normal Marker X Rel Mode
MRON (?) d	5-39	Set Marker to Ref

Harmonic Marker

HRMN (?) d {, i}	5-41	Number of Harmonics
HDSP (?) d {, i}	5-41	Harmonic/Sideband Display
HRDO (?) d {, i}	5-41	Harmonic/Sideband Readout
HTHD ? d, i	5-41	Query the Total Harmonic Distortion
HPWR ? d	5-41	Query the Harmonic Power

Sideband Marker

SSEP (?) d {, f}	5-42	Sideband Separation
SDBN (?) d {, i}	5-42	Number of Sidebands
HDSP (?) d {, i}	5-42	Harmonic/Sideband Display
HRDO (?) d {, i}	5-42	Harmonic/Sideband Readout
SPWR ? d, i	5-42	Query the Sideband Power

Band Marker

BMKL (?) d, i {, j}	5-43	Band i Left Bin j
BMKR (?) d, i {, j}	5-43	Band i Right Bin j
BEXC ? d {, i}	5-43	Band Exclude
BRAM ? d {, i}	5-43	Band Ratio Mode

5-4 Index of Commands

BPWR ? d, i 5-43 Band Power
BRAT ? d, i 5-43 Band Ratio

Source

SRCO (?) {i} 5-44 Source On/Off
STYP (?) {i} 5-44 Source Type

Sine Source

S1FR (?) {f} 5-45 Sine Frequency 1
S1AM (?) {x} 5-45 Sine Amplitude 1
S2FR (?) {f} 5-45 Sine Frequency 2
S2AM (?) {x} 5-45 Sine Amplitude 2
SOFF (?) {x} 5-45 Sine Offset

Chirp Source

CAMP (?) {x} 5-46 Chirp Amplitude
CBUR (?) {x} 5-46 Chirp Burst Percentage
CSRC (?) {i} 5-46 Source Display

Noise Source

NAMP (?) {x} 5-47 Noise Amplitude
NTYP (?) {i} 5-47 Noise Type
NBUR (?) {x} 5-47 Noise Burst Percentage
NPER (?) {x} 5-47 Noise Source Period
CSRC (?) {i} 5-47 Source Display

Arbitrary Source

AAMP (?) {i} 5-48 Arbitrary Source Amplitude
ARAT (?) {i} 5-48 Arbitrary Source Rate
ASRC (?) {i} 5-48 Arbitrary Source Buffer
ASTR (?) {i} 5-48 Arbitrary Source Start
ALEN (?) {i} 5-48 Arbitrary Source Length
TARB i 5-48 Trace to Arb
ALOD ? n 5-94 Download Arbitrary Binary
AGET ? i 5-96 Upload Arbitrary Buffer
APUT ? i 5-96 Download Arbitrary Buffer

Swept Sine Source (Swept Sine Measurement Group)

SSAL (?) {i} 5-49 Swept Sine Auto Level
SSAM (?) {x} 5-49 Swept Sine Amplitude
SSRF (?) {x} 5-49 Swept Sine Ideal Reference
SRMP (?) {i} 5-49 Swept Sine Source Ramping Off/On
SRAT (?) {x} 5-49 Swept Sine Ramp Rate
SSUL (?) {x} 5-49 Swept Sine Upper Limit
SSLL (?) {x} 5-49 Swept Sine Lower Limit
SMAX (?) {x} 5-50 Swept Sine Max Level

Inputs

ISRC (?) {i} 5-51 Input Source
I1MD (?) {i} 5-51 Ch1 Input Mode
I1GD (?) {i} 5-51 Ch1 Input Grounding
I1CP (?) {i} 5-51 Ch1 Input Coupling
I1RG (?) {i} 5-51 Ch1 Input Range
A1RG (?) {i} 5-51 Ch1 AutoRange Off/On

I1AR (?) {i}	5-51	Ch1 AutoRange Mode
I1AF (?) {i}	5-51	Ch1 Anti-Alias Filter
I1AW (?) {i}	5-51	Ch1 A-Weight Filter
I2MD (?) {i}	5-51	Ch2 Input Mode
I2GD (?) {i}	5-51	Ch2 Input Grounding
I2CP (?) {i}	5-52	Ch2 Input Coupling
I2RG (?) {i}	5-52	Ch2 Input Range
A2RG (?) {i}	5-52	Ch2 AutoRange Off/On
I2AR (?) {i}	5-52	Ch2 AutoRange Mode
I2AF (?) {i}	5-52	Ch2 Anti-Alias Filter
I2AW (?) {i}	5-52	Ch2 A-Weight Filter
IAOM (?) {i}	5-52	Auto Offset
EU1M (?) {i}	5-52	Ch1 Engineering Units Off/On
EU1L (?) {i}	5-52	Ch1 EU Label
EU1V (?) {x}	5-53	Ch1 EU/Volt
EU1U (?) {s}	5-53	Ch1 User Label
EU2M (?) {i}	5-53	Ch2 Engineering Units Off/On
EU2L (?) {i}	5-53	Ch2 EU Label
EU2V (?) {x}	5-53	Ch2 EU/Volt
EU2U (?) {s}	5-53	Ch2 User Label
INPC ? i	5-106	Input Ovld Read

Input Playback

ISTR (?) {i}	5-54	Capture Playback Start
ILEN (?) {i}	5-54	Capture Playback Length
IMOD (?) {i}	5-54	Capture Playback Mode
ISPD (?) {i}	5-54	Capture Playback Speed

Trigger

TMOD (?) {i}	5-55	Trigger Mode
TSRC (?) {i}	5-55	Trigger Source
TLVL (?) {i}	5-55	Trigger Level
TSLP (?) {i}	5-55	Trigger Slope
TDLA (?) {i}	5-55	Trigger Delay A
TDLB (?) {i}	5-55	Trigger Delay B
TARM	5-55	Manual Trigger Arm
STMD (?) {i}	5-55	Triggered Source Mode
TMAN	5-55	Manual Trigger

Average (FFT Measurement Group)

FAVG (?) d {, i}	5-56	FFT Average On
FAVM (?) d {, i}	5-56	FFT Average Mode
FAVT (?) d {, i}	5-56	FFT Average Type
FAVN (?) d {, i}	5-56	FFT Average Number
NAVG ? d	5-56	FFT Averages Completed?
FOVL (?) d {, x}	5-56	FFT Time Record Increment
FREJ (?) d {, i}	5-57	FFT Overload Reject
PAVO (?) d {, i}	5-57	Average Preview
PAVT (?) d {, x}	5-57	Preview Time
PAVA	5-57	Accept Preview
PAVR	5-57	Reject Preview

5-6 Index of Commands

Average (Octave Measurement Group)

OTYP (?) d {, i}	5-58	Octave Average Type
OTIM (?) d {, x}	5-58	Octave Average Time
NAVG ? d	5-58	Octave Averages Completed?
OCNF (?) d {, i}	5-58	Octave Confidence Level
OIMP (?) d {, i}	5-58	Octave Power Bin
OLAT (?) d {, i}	5-59	Octave Linear Average Mode

Average (Swept Sine Measurement Group)

SSTM (?) d {, x}	5-60	Swept Sine Settle Time
SSCY (?) d {, i}	5-60	Swept Sine Settle Cycles
SITM (?) d {, x}	5-60	Swept Sine Int. Time
SICY (?) d {, i}	5-60	Swept Sine Int. Cycles

User Math Functions

USRF (?) i {, j, k, l ...}	5-61	FFT User Function i
USRO (?) i {, j, k, l ...}	5-61	Octave User Function i
USRS (?) i {, j, k, l ...}	5-61	Swept Sine User Function i
USRC (?) i {, x, y}	5-62	User Constant i

Window (FFT Measurement Group)

FWIN (?) d {, i}	5-63	FFT Window
FWFL (?) d {, i}	5-63	FFT Force Length
FWTC (?) d {, i}	5-63	FFT Expo TC
TRWI d, i	5-63	Trace i to Window
WITR d, i	5-64	Window to Trace i
WSYM (?) d {, i}	5-64	Window Form

Waterfall (FFT & Octave Measurement Group)

WDSP (?) d {, i}	5-65	Waterfall Display
WSTO (?) d {, i}	5-65	Waterfall Storage
WAVA ? d	5-65	Waterfall Records Stored?
WTOT (?) d {, i}	5-65	Waterfall Total Count
WFSK (?) d {, i}	5-65	Waterfall FFT Skip
WOSK (?) d {, x}	5-65	Waterfall Octave Skip
WVCT (?) d {, i}	5-65	Waterfall View Count
WHIT (?) d {, i}	5-66	Waterfall Trace Height
WANG (?) d {, i}	5-66	Waterfall Angle
WFST (?) d {, i}	5-66	Waterfall Fast Angles
WTHR (?) d {, i}	5-66	Waterfall Threshold
WHID (?) d {, i}	5-66	Waterfall Hidden Lines
WREV (?) d {, i}	5-66	Waterfall Paused Drawing
WTRC d, i, j	5-66	Waterfall Record to Trace
WSLC d, i, j	5-66	Waterfall Slice to Trace
WGET ?	5-98	Upload Waterfall Buffer
WPUT ?	5-99	Download Waterfall Buffer

Capture

CCHN (?) {i}	5-68	Capture Channels
CMOD (?) {i}	5-68	Capture Mode
CLEN (?) {i}	5-68	Capture Length
CRAT (?) {i}	5-68	Capture Rate
CPAN (?) {i}	5-68	Capture Auto Pan
CSTR	5-68	Capture Start

CSTP	5-68	Capture Stop
CGET ? i, j	5-97	Upload Capture Buffer
CPUT ? i, j	5-29	Download Capture Buffer

Memory

MMEM ?	5-69	Total Memory Available
MALC i, j, k	5-69	Allocate Memory

Data Table

DTBL (?) d {, i}	5-70	Data Table On
DMAX ? d {, i}	5-70	Data Table Length
DINS d, i, j	5-70	Data Table Insert bin j at line i
DDLT d, i	5-70	Data Table Delete
DCLR d	5-70	Data Table Clear
DTRD ? d {, i}	5-71	Data Table Query

Limit Testing

LSON (?) d {, i}	5-72	Show Limit Segments
LTST (?) d {, i}	5-72	Limit Testing On
LALM (?) d {, i}	5-72	Limit Beep
LFAL ? d	5-72	Limit Test Fail?
LCLR d	5-72	Clear Limits
LMAX (?) d {, i}	5-72	Last Limit Segment #
LSEG (?) d, i {, j, x0, y0, x1, y1}	5-72	Set Limit Segment i
LDLT d, i	5-73	Delete Limit Segment
LSFT d, x	5-73	Shift Limit Segments

Marker Statistics

MSAO (?) d {, i}	5-74	Marker Statistics On
MSRS	5-74	Reset Marker Statistics
MSAA ?	5-74	Marker Max A Read
MSIA ?	5-74	Marker Min A Read
MSEA ?	5-74	Marker Mean A Read
MSSA ?	5-74	Marker Std Dev A Read
MSAB ?	5-74	Marker Max B Read
MSIB ?	5-74	Marker Min B Read
MSEB ?	5-74	Marker Mean B Read
MSSB ?	5-74	Marker Std Dev B Read

Exceedance Statistics

ESTR (?) {i}	5-75	Exceed Start Index
ESTP (?) {i}	5-75	Exceed Stop Index
EPCT (?) {i}	5-75	Exceed Centile
EXCE d, i	5-75	Calculate Exceedance

Disk

FNAM (?) {s}	5-76	Save/Recall File Name
FDIR (?) {s}	5-76	Save/Recall Directory
MDIR s	5-76	Make Directory
FXST ? s	5-76	File Exist?
FREE ?	5-76	Disk Free Space?
FRST ?	5-77	Reset Disk Catalog
FNXT ?	5-77	Read Disk Catalog
FSAV d	5-76	Display to Disk

5-8 Index of Commands

FRCL d	5-77	Disk to Display
SSAV	5-77	Settings to Disk
SRCL i	5-77	Recall Settings
TSAV i	5-78	Trace i to Disk
TRCL i	5-78	Disk to Trace i
DNAM (?) {s}	5-78	Upkeep File Name
DELF	5-78	Delete File
DELD	5-78	Delete Directory

Output

POUT (?) {i}	5-79	Print Screen hardkey
PDST (?) {i}	5-79	Print/Plot Destination
PFIL (?) {i}	5-79	File Start Number
DUMP	5-79	Dump Display Data
PRNT	5-79	Print Screen
PRTP (?) {i}	5-79	Bitmap/Printer Type
PSCR (?) {i}	5-79	Bitmap Area
PBRI (?) {i}	5-79	Print Bright
PDIM (?) {i}	5-80	Print Dim
PBLK (?) {i}	5-80	Print Black
PGRF (?) {i}	5-80	Print Graph
PLOT	5-80	Plot Screen
PLTP (?) {i}	5-80	Vector/Plotter Type
PLTA (?) {i}	5-80	Plotter GPIB Address
PCIC (?) {i}	5-80	GPIB Control
PLTX (?) {i}	5-80	Plotter Text Pen
PLGD (?) {i}	5-80	Plotter Grid Pen
PLTR (?) {i}	5-80	Plotter Trace Pen
PLMK (?) {i}	5-80	Plotter Marker Pen
NOTE i, j {, k, l, m, s}	5-80	Display Note

System

OUTX (?) {i}	5-82	Output Remote Interface
OVRM (?) {i}	5-82	Override Remote
KCLK (?) {i}	5-82	Key Click
ALRM (?) {i}	5-82	Alarms On
ALRT (?) {i}	5-82	Alarms Volume
ADON (?) {i}	5-82	Done Volume
AOVL (?) {i}	5-82	Audible Overload
SAVR (?) {i}	5-82	Screen Saver On
SDLY (?) {i}	5-82	Screen Saver Delay
FFMT (?) {i}	5-82	Frequency Format
TIME (?) {i, j, k}	5-82	Time
DATE (?) {i, j, k}	5-83	Date

Front Panel

ACTD (?) i	5-84	Active Display
STRT	5-84	Start/Reset
PAUS	5-84	Pause
CONT	5-84	Continue
UNST d	5-84	Unsettle Measurement
CSTR	5-68	Capture Start
CSTP	5-68	Capture Stop
SVTR d, i	5-84	Display d to Trace i

RCTR d, i	5-84	Trace i to Display d
SVRF d, i	5-85	Reference to Trace
RCRF d, i	5-85	Trace to Reference
DUMP	5-85	Dump Display Data
PRNT	5-85	Print Screen
PLOT	5-85	Plot Screen
ASCL d	5-85	AutoScale
A1RG (?) {i}	5-85	Ch1 AutoRange Off/On
A2RG (?) {i}	5-85	Ch2 AutoRange Off/On
MRON (?) d	5-85	Set Marker to Ref
MKMX d	5-85	Move the Marker to the Maximum
MKMN d	5-86	Move the Marker to the Minimum
MKCN d	5-86	Center of FFT Span to Marker
DREF d, i	5-86	Display Ref
SNAP d	5-86	Snap Reference
SBRI (?) {i}	5-82	Screen Brightness
SCON (?) {i}	5-86	Screen Contrast
KEYP i	5-86	Key Press
KNOB i	5-88	Knob
TONE i, j	5-88	Tone
PLAY i	5-88	Play Tune

Traces

SVTR d, i	5-84	Display d to Trace i
RCTR d, i	5-84	Trace i to Display d
TSAV i	5-78	Trace i to Disk
TRCL i	5-78	Disk to Trace i
TLOD ? i, n	5-92	Download Trace i Binary
TASC ? i, n	5-93	Download Trace i Ascii
TGET ? i	5-95	Upload Trace i Buffer
TPUT ? i	5-95	Download Trace i Buffer

Data Transfer

DSPN ? d	5-89	Display d Length
DSPY ? d {, j}	5-89	Read Display d (bin j) ASCII
DSPW ? d, i {, j}	5-89	Read Waterfall d Record i (bin j) ASCII
REFY ? d, j	5-89	Read Ref Display d bin j
DSPB ? d {, j}	5-89	Read Display d Binary
DSWB ? d, i {, j}	5-91	Read Display d Waterfall Record i Binary
DBIN ? d, j	5-91	Read Display d Bin Freq or Time
FBIN ? d, x	5-92	Read Display d Bin Number
TLOD ? i, n	5-92	Download Trace i Binary
TASC ? i, n	5-93	Download Trace i Ascii
ALOD ? n	5-94	Download Arbitrary Binary
TGET ? i	5-95	Upload Trace i Buffer
TPUT ? i	5-95	Download Trace i Buffer
AGET ? i	5-96	Upload Arbitrary Buffer
APUT ? i	5-96	Download Arbitrary Buffer
CGET ? i, j	5-97	Upload Capture Buffer
CPUT ? i, j	5-29	Download Capture Buffer
WGET ?	5-98	Upload Waterfall Buffer
WPUT ?	5-99	Download Waterfall Buffer

5-10 Index of Commands

Interface

*RST	5-101	Reset
*IDN ?	5-101	Device Identification?
LOCL (?) {i}	5-101	Local/Remote
OVRM (?) {i}	5-101	Override Remote

Nodal Degree-of-Freedom Information

SVNI (?) {i}	5-102	Save Nodal Information
RFDR (?) {i}	5-102	Reference Node Direction
RFNA (?) {s}	5-102	Reference Node Name
RFNU (?) {i}	5-102	Reference Node Number
RSDR (?) {i}	5-102	Response Node Direction
RSNA (?) {s}	5-103	Response Node Name
RSNU (?) {i}	5-103	Response Node Number

Status

*CLS	5-104	Clear All Status Registers
*PSC (?) {i}	5-104	Power On Status Clear
*SRE (?) {i} {,j}	5-104	Serial Poll Status Enable
*STB ? {i}	5-104	Serial Poll Status Read
*ESE (?) {i} {,j}	5-104	Standard Event Status Enable
*ESR ? {i}	5-105	Standard Event Status Read
ERRE (?) {i} {,j}	5-105	Error Status Enable
ERRS ? {i}	5-105	Error Status Read
INSE (?) {i} {,j}	5-105	Instrument Status Enable
INST ? {i}	5-106	Instrument Status Read
DSPE (?) {i} {,j}	5-106	Display Status Enable
DSPS ? {i}	5-106	Display Status Read
INPE (?) {i} {,j}	5-106	Input Status Enable
INPS ? {i}	5-106	Input Status Read
INPC ? i	5-106	Input OvlD Read

Alphabetical List of Commands

*		
*CLS	5-104	Clear All Status Registers
*ESE (?) {i} {, j}	5-104	Standard Event Status Enable
*ESR ? {i}	5-105	Standard Event Status Read
*IDN ?	5-101	Device Identification?
*PSC (?) {i}	5-104	Power On Status Clear
*RST	5-101	Reset
*SRE (?) {i} {, j}	5-104	Serial Poll Status Enable
*STB ? {i}	5-104	Serial Poll Status Read

A

A1RG (?) {i}	5-51	Ch1 AutoRange Off/On
A2RG (?) {i}	5-52	Ch2 AutoRange Off/On
AAMP (?) {i}	5-48	Arbitrary Source Amplitude
ACTD (?) i	5-84	Active Display
ADON (?) {i}	5-82	Done Volume
AGET ? i	5-96	Upload Arbitrary Buffer
ALEN (?) {i}	5-48	Arbitrary Source Length
ALOD ? n	5-94	Download Arbitrary Binary
ALRM (?) {i}	5-82	Alarms On
ALRT (?) {i}	5-82	Alarms Volume
AOVL (?) {i}	5-82	Audible Overload
APUT ? i	5-96	Download Arbitrary Buffer
ARAT (?) {i}	5-48	Arbitrary Source Rate
ASCL d	5-85	AutoScale
ASRC (?) {i}	5-48	Arbitrary Source Buffer
ASTR (?) {i}	5-48	Arbitrary Source Start

B

BEXC ? d {, i}	5-43	Band Exclude
BMKL (?) d, i {, j}	5-43	Band i Left Bin j
BMKR (?) d, i {, j}	5-43	Band i Right Bin j
BPWR ? d, i	5-43	Band Power
BRAM ? d {, i}	5-43	Band Ratio Mode
BRAT ? d, i	5-43	Band Ratio

C

CAMP (?) {x}	5-46	Chirp Amplitude
CBUR (?) {x}	5-46	Chirp Burst Percentage
CCHN (?) {i}	5-68	Capture Channels
CGET ? i, j	5-97	Upload Capture Buffer
CLEN (?) {i}	5-68	Capture Length
CMOD (?) {i}	5-68	Capture Mode
CONT	5-84	Continue
CPAN (?) {i}	5-68	Capture Auto Pan
CPUT ? i, j	5-29	Download Capture Buffer
CRAT (?) {i}	5-68	Capture Rate
CSRC (?) {i}	5-46	Source Display
CSTP	5-68	Capture Stop
CSTR	5-68	Capture Start

5-12 Index of Commands

D

DATE (?) {i, j, k}	5-83	Date
DBIN ? d, j	5-91	Read Display d Bin Freq or Time
DBMR (?) {x}	5-36	dBm Reference Impedance
DCLR d	5-70	Data Table Clear
DDLT d, i	5-70	Data Table Delete
DDXW (?) d {, x}	5-36	d/dx Window
DELD	5-78	Delete Directory
DELF	5-78	Delete File
DFMT (?) {i}	5-35	Display Format
DINS d, i, j	5-70	Data Table Insert bin j at line i
DISP (?) d {, i}	5-35	Display Update Mode
DMAX ? d {, i}	5-70	Data Table Length
DNAM (?) {s}	5-78	Upkeep File Name
DREF d, i	5-86	Display Ref
DSPB ? d {, j}	5-89	Read Display d Binary
DSPE (?) {i} {, j}	5-106	Display Status Enable
DSPN ? d	5-89	Display d Length
DSPS ? {i}	5-106	Display Status Read
DSPW ? d, i {, j}	5-89	Read Waterfall d Record i (bin j) ASCII
DSPY ? d {, j}	5-89	Read Display d (bin j) ASCII
DSWB ? d, i {, j}	5-91	Read Display d Waterfall Record i Binary
DTBL (?) d {, i}	5-70	Data Table On
DTRD ? d {, i}	5-71	Data Table Query
DUMP	5-79	Dump Display Data

E

EPCT (?) {i}	5-75	Exceed Centile
ERRE (?) {i} {, j}	5-105	Error Status Enable
ERRS ? {i}	5-105	Error Status Read
ESTP (?) {i}	5-75	Exceed Stop Index
ESTR (?) {i}	5-75	Exceed Start Index
EU1L (?) {i}	5-52	Ch1 EU Label
EU1M (?) {i}	5-52	Ch1 Engineering Units Off/On
EU1U (?) {s}	5-53	Ch1 User Label
EU1V (?) {x}	5-53	Ch1 EU/Volt
EU2L (?) {i}	5-53	Ch2 EU Label
EU2M (?) {i}	5-53	Ch2 Engineering Units Off/On
EU2U (?) {s}	5-53	Ch2 User Label
EU2V (?) {x}	5-53	Ch2 EU/Volt
EXCE d, i	5-75	Calculate Exceedance

F

FAVG (?) d {, i}	5-56	FFT Average On
FAVM (?) d {, i}	5-56	FFT Average Mode
FAVN (?) d {, i}	5-56	FFT Average Number
FAVT (?) d {, i}	5-56	FFT Average Type
FBAS (?) d {, i}	5-25	FFT Base Frequency
FBIN ? d, x	5-92	Read Display d Bin Number
FCTR (?) d {, f}	5-25	FFT Center Frequency
FDIR (?) {s}	5-76	Save/Recall Directory
FEND (?) d {, f}	5-26	FFT End Frequency
FFMT (?) {i}	5-82	Frequency Format
FLIN (?) d {, i}	5-25	FFT Resolution

FNAM (?) {s}	5-76	Save/Recall File Name
FNXT ?	5-77	Read Disk Catalog
FOVL (?) d {, x}	5-56	FFT Time Record Increment
FRCL d	5-77	Disk to Display
FREE ?	5-76	Disk Free Space?
FREJ (?) d {, i}	5-57	FFT Overload Reject
FRST ?	5-77	Reset Disk Catalog
FSAV d	5-76	Display to Disk
FSPN (?) d {, f}	5-25	FFT Frequency Span
FSTR (?) d {, f}	5-25	FFT Start Frequency
FWFL (?) d {, i}	5-63	FFT Force Length
FWIN (?) d {, i}	5-63	FFT Window
FWTC (?) d {, i}	5-63	FFT Expo TC
FXST ? s	5-76	File Exist?

G

GDIV (?) d {, i}	5-35	Number of Grid Divisions
GRID (?) d {, i}	5-35	Grid On/Off

H

HDSP (?) d {, i}	5-41	Harmonic/Sideband Display
HPWR ? d	5-41	Query the Harmonic Power
HRDO (?) d {, i}	5-41	Harmonic/Sideband Readout
HRMN (?) d {, i}	5-41	Number of Harmonics
HTHD ? d, i	5-41	Query the Total Harmonic Distortion

I

I1AF (?) {i}	5-51	Ch1 Anti-Alias Filter
I1AR (?) {i}	5-51	Ch1 AutoRange Mode
I1AW (?) {i}	5-51	Ch1 A-Weight Filter
I1CP (?) {i}	5-51	Ch1 Input Coupling
I1GD (?) {i}	5-51	Ch1 Input Grounding
I1MD (?) {i}	5-51	Ch1 Input Mode
I1RG (?) {i}	5-51	Ch1 Input Range
I2AF (?) {i}	5-52	Ch2 Anti-Alias Filter
I2AR (?) {i}	5-52	Ch2 AutoRange Mode
I2AW (?) {i}	5-52	Ch2 A-Weight Filter
I2CP (?) {i}	5-52	Ch2 Input Coupling
I2GD (?) {i}	5-51	Ch2 Input Grounding
I2MD (?) {i}	5-51	Ch2 Input Mode
I2RG (?) {i}	5-52	Ch2 Input Range
IAOM (?) {i}	5-52	Auto Offset
ILEN (?) {i}	5-54	Capture Playback Length
IMOD (?) {i}	5-54	Capture Playback Mode
INPC ? i	5-106	Input OvlD Read
INPE (?) {i} {, j}	5-106	Input Status Enable
INPS ? {i}	5-106	Input Status Read
INSE (?) {i} {, j}	5-105	Instrument Status Enable
INST ? {i}	5-106	Instrument Status Read
ISPD (?) {i}	5-54	Capture Playback Speed
ISRC (?) {i}	5-51	Input Source
ISTR (?) {i}	5-54	Capture Playback Start

5-14 Index of Commands

K

KCLK (?) {i}	5-82	Key Click
KEYP i	5-86	Key Press
KNOB i	5-88	Knob

L

LALM (?) d {, i}	5-72	Limit Beep
LCLR d	5-72	Clear Limits
LDLT d, i	5-73	Delete Limit Segment
LFAL ? d	5-72	Limit Test Fail?
LMAX (?) d {, i}	5-72	Last Limit Segment #
LOCL (?) {i}	5-101	Local/Remote
LSEG (?) d, i {, j, x0, y0, x1, y1}	5-72	Set Limit Segment i
LSFT d, x	5-73	Shift Limit Segments
LSO (?) d {, i}	5-72	Show Limit Segments
LTST (?) d {, i}	5-72	Limit Testing On

M

MALC i, j, k	5-69	Allocate Memory
MBIN d, i	5-37	Marker Move to bin i
MDIR s	5-76	Make Directory
MEAS (?) d {, i}	5-31	Display Measurement
MGRP (?) d {, i}	5-31	Measurement Group
MKCN d	5-38	Center of FFT Span to Marker
MKMD (?) d {, i}	5-37	Marker Mode
MKMN d	5-38	Move the Marker to the Minimum
MKMX d	5-38	Move the Marker to the Maximum
MMEM ?	5-69	Total Memory Available
MREL (?) d {, i}	5-39	Normal Marker Relative Mode
MRKB ? d	5-37	Query the Marker Bin
MRKR (?) d {, i}	5-37	Marker Tracking
MRKX ? d	5-37	Query the Marker X Position
MRKY ? d	5-37	Query the Marker Y Position
MRKZ ? d	5-38	Marker Z Read
MRON (?) d	5-39	Set Marker to Ref
MROX (?) d {, x}	5-39	Normal Marker X Offset
MROY (?) d {, x}	5-39	Normal Marker Y Offset
MSAA ?	5-74	Marker Max A Read
MSAB ?	5-74	Marker Max B Read
MSAO (?) d {, i}	5-74	Marker Statistics On
MSEA ?	5-74	Marker Mean A Read
MSEB ?	5-74	Marker Mean B Read
MSEK (?) d {, i}	5-39	Normal Marker Seeks Mode
MSIA ?	5-74	Marker Min A Read
MSIB ?	5-74	Marker Min B Read
MSRS	5-74	Reset Marker Statistics
MSSA ?	5-74	Marker Std Dev A Read
MSSB ?	5-74	Marker Std Dev B Read
MWFL d, i	5-37	Marker Move Waterfall to record i
MWID (?) d {, i}	5-39	Normal Marker Width
MXRL (?) d {, i}	5-39	Normal Marker X Rel Mode

N

NAMP (?) {x}	5-47	Noise Amplitude
NAVG ? d	5-56	FFT Averages Completed?
NAVG ? d	5-58	Octave Averages Completed?
NBUR (?) {x}	5-47	Noise Burst Percentage
NOTE i, j {, k, l, m, s}	5-80	Display Note
NPER (?) {x}	5-47	Noise Source Period
NTYP (?) {i}	5-47	Noise Type

O

OCHN (?) {i}	5-27	Octave Channels
OCNF (?) d {, i}	5-58	Octave Confidence Level
OHIB (?) d {, f}	5-27	Octave Highest Band
OIMP (?) d {, i}	5-58	Octave Power Bin
OLAT (?) d {, i}	5-59	Octave Linear Average Mode
OLOB (?) d {, f}	5-27	Octave Lowest Band
ORES (?) d {, i}	5-27	Octave Resolution
OTIM (?) d {, x}	5-58	Octave Average Time
OTYP (?) d {, i}	5-58	Octave Average Type
OUTX (?) {i}	5-82	Output Remote Interface
OVRM (?) {i}	5-101	Override Remote

P

PAUS	5-84	Pause
PAVA	5-57	Accept Preview
PAVO (?) d {, i}	5-57	Average Preview
PAVR	5-57	Reject Preview
PAVT (?) d {, x}	5-57	Preview Time
PBLK (?) {i}	5-80	Print Black
PBRI (?) {i}	5-79	Print Bright
PCIC (?) {i}	5-80	GPIB Control
PDIM (?) {i}	5-80	Print Dim
PDST (?) {i}	5-79	Print/Plot Destination
PFIL (?) {i}	5-79	File Start Number
PGRF (?) {i}	5-80	Print Graph
PHSL (?) d {, x}	5-36	Phase Suppress Threshold
PLAY i	5-88	Play Tune
PLGD (?) {i}	5-80	Plotter Grid Pen
PLMK (?) {i}	5-80	Plotter Marker Pen
PLOT	5-80	Plot Screen
PLTA (?) {i}	5-80	Plotter GPIB Address
PLTP (?) {i}	5-80	Vector/Plotter Type
PLTR (?) {i}	5-80	Plotter Trace Pen
PLTX (?) {i}	5-80	Plotter Text Pen
POUT (?) {i}	5-79	Print Screen hardkey
PRNT	5-79	Print Screen
PRTP (?) {i}	5-79	Bitmap/Printer Type
PSCR (?) {i}	5-79	Bitmap Area
PSDU (?) d {, i}	5-35	PSD Units On/Off

R

RCRF d, i	5-85	Trace to Reference
RCTR d, i	5-84	Trace i to Display d
REFY ? d, j	5-89	Read Ref Display d bin j

5-16 Index of Commands

RFDR (?) {i}	5-102	Reference Node Direction
RFNA (?) {s}	5-102	Reference Node Name
RFNU (?) {i}	5-102	Reference Node Number
RSDR (?) {i}	5-102	Response Node Direction
RSNA (?) {s}	5-103	Response Node Name
RSNU (?) {i}	5-103	Response Node Number

S

S1AM (?) {x}	5-45	Sine Amplitude 1
S1FR (?) {f}	5-45	Sine Frequency 1
S2AM (?) {x}	5-45	Sine Amplitude 2
S2FR (?) {f}	5-45	Sine Frequency 2
SOFF (?) {x}	5-45	Sine Offset
SARS (?) d {, i}	5-29	Swept Sine Auto Resolution
SAVR (?) {i}	5-82	Screen Saver On
SBRI (?) {i}	5-82	Screen Brightness
SCON (?) {i}	5-86	Screen Contrast
SDBN (?) d {, i}	5-42	Number of Sidebands
SDLY (?) {i}	5-82	Screen Saver Delay
SFST (?) d {, x}	5-30	Swept Sine Faster Threshold
SICY (?) d {, i}	5-60	Swept Sine Int. Cycles
SITM (?) d {, x}	5-60	Swept Sine Int. Time
SMAX (?) {x}	5-50	Swept Sine Max Level
SNAP d	5-86	Snap Reference
SNPS (?) d {, i}	5-30	Swept Sine Number of Points
SPWR ? d, i	5-42	Query the Sideband Power
SRAT (?) {x}	5-49	Swept Sine Ramp Rate
SRCL i	5-77	Recall Settings
SRCO (?) {i}	5-44	Source On/Off
SRMP (?) {i}	5-49	Swept Sine Source Ramping Off/On
SRPT (?) d {, i}	5-29	Swept Sine Repeat Mode
SSAL (?) {i}	5-49	Swept Sine Auto Level
SSAM (?) {x}	5-49	Swept Sine Amplitude
SSAV	5-77	Settings to Disk
SSCY (?) d {, i}	5-60	Swept Sine Settle Cycles
SSEP (?) d {, f}	5-42	Sideband Separation
SSFR ?	5-29	Swept Sine Progress?
SSKP (?) d {, i}	5-30	Swept Sine Max Step Size
SSLL (?) {x}	5-49	Swept Sine Lower Limit
SSLO (?) d {, x}	5-30	Swept Sine Slower Threshold
SSRF (?) {x}	5-49	Swept Sine Ideal Reference
SSTM (?) d {, x}	5-60	Swept Sine Settle Time
SSTP (?) d {, f}	5-29	Swept Sine Stop Frequency
SSTR (?) d {, f}	5-29	Swept Sine Start Frequency
SSTY (?) d {, i}	5-29	Swept Sine Sweep Type
SSUL (?) {x}	5-49	Swept Sine Upper Limit
STMD (?) {i}	5-55	Triggered Source Mode
STRT	5-84	Start/Reset
STYP (?) {i}	5-44	Source Type
SVNI (?) {i}	5-102	Save Nodal Information
SVRF d, i	5-85	Reference to Trace
SVTR d, i	5-84	Display d to Trace i

T

TARB i	5-48	Trace to Arb
--------	------	--------------

TARM	5-55	Manual Trigger Arm
TASC ? i, n	5-93	Download Trace i Ascii
TDLA (?) {i}	5-55	Trigger Delay A
TDLB (?) {i}	5-55	Trigger Delay B
TDRC (?) d {, i}	5-36	Transducer Unit Convert
TGET ? i	5-95	Upload Trace i Buffer
TIME (?) {i, j, k}	5-82	Time
TLOD ? i, n	5-92	Download Trace i Binary
TLVL (?) {i}	5-55	Trigger Level
TMAN	5-55	Manual Trigger
TMOD (?) {i}	5-55	Trigger Mode
TONE i, j	5-88	Tone
TPUT ? i	5-95	Download Trace i Buffer
TRCL i	5-78	Disk to Trace i
TRWI d, i	5-63	Trace i to Window
TSAV i	5-78	Trace i to Disk
TSLP (?) {i}	5-55	Trigger Slope
TSRC (?) {i}	5-55	Trigger Source

U

UNIT (?) d {, i}	5-33	Display Units
UNST d	5-84	Unsettle Measurement
USRC (?) i {, x, y}	5-62	User Constant i
USRF (?) i {, j, k, l ...}	5-61	FFT User Function i
USRO (?) i {, j, k, l ...}	5-61	Octave User Function i
USRS (?) i {, j, k, l ...}	5-61	Swept Sine User Function i

V

VIEW (?) d {, i}	5-32	Display View
------------------	------	--------------

W

WANG (?) d {, i}	5-66	Waterfall Angle
WAVA ? d	5-65	Waterfall Records Stored?
WDSP (?) d {, i}	5-65	Waterfall Display
WFSK (?) d {, i}	5-65	Waterfall FFT Skip
WFST (?) d {, i}	5-66	Waterfall Fast Angles
WGET ?	5-98	Upload Waterfall Buffer
WHID (?) d {, i}	5-66	Waterfall Hidden Lines
WHIT (?) d {, i}	5-66	Waterfall Trace Height
WITR d, i	5-64	Window to Trace i
WOSK (?) d {, x}	5-65	Waterfall Octave Skip
WPUT ?	5-99	Download Waterfall Buffer
WREV (?) d {, i}	5-66	Waterfall Paused Drawing
WSLC d, i, j	5-66	Waterfall Slice to Trace
WSTO (?) d {, i}	5-65	Waterfall Storage
WSYM (?) d {, i}	5-64	Window Form
WTHR (?) d {, i}	5-66	Waterfall Threshold
WTOT (?) d {, i}	5-65	Waterfall Total Count
WTRC d, i, j	5-66	Waterfall Record to Trace
WVCT (?) d {, i}	5-65	Waterfall View Count

X

XAXS (?) d {, i}	5-35	X Axis Scale Type
XCEN (?) d {, x}	5-34	X Center (Polar)

5-18 Index of Commands

XDIV (?) d {, x}	5-34	X/Division (Polar)
XPAN (?) d {, i}	5-34	X Pan
XZOM (?) d {, i}	5-34	X Zoom

Y

Y2DV (?) d {, x}	5-34	Y/Division (Polar)
YCEN (?) d {, x}	5-34	Y Center (Polar)
YDIV (?) d {, x}	5-34	Y/Division
YMAX (?) d {, x}	5-33	Y Maximum
YMID (?) d {, x}	5-33	Y Midpoint
YMIN (?) d {, x}	5-33	Y Minimum

Introduction

The SR780 Network Signal Analyzer may be remotely programmed via either the RS232 or GPIB (IEEE-488) interfaces. Any computer supporting one of these interfaces may be used to program the SR780. Both interfaces are receiving at all times, however, the SR780 will send responses only to the Output Interface specified in the [System] <Remote> menu.

Use the OUTX command at the beginning of every program to direct the SR780 responses to the correct interface.

Communicating With GPIB

The SR780 supports the IEEE-488.1 (1978) interface standard. It also supports the required common commands of the IEEE-488.2 (1987) standard. Before attempting to communicate with the SR780 over the GPIB interface, the SR780's Device Address must be set in the [System] <Remote> menu.

Communicating With RS232

The SR780 is configured as a DCE (transmit on pin 3, receive on pin 2) device and supports CTS/DTR hardware handshaking. The CTS signal (pin 5) is an output indicating that the SR780 is ready, while the DTR signal (pin 20) is an input that is used to control the SR780's data transmission. If desired, the handshake pins may be ignored and a simple 3 wire interface (pins 2,3 and 7) may be used. The RS232 interface Baud Rate, Word Length, and Parity must be set in the [System] <Remote> menu.

Screen Indicators And Queues

To assist in programming, the SR780 has 4 interface indicators which are displayed at the top of the screen.

The RS232/gpib indicator shows 'RS232' if the interface responses are directed to the RS232 serial port and 'gpib' and the address if the interface responses are directed to the GPIB port.

The comm indicator flashes 'RS232' when there is activity on the RS232 interface and 'GPIB' when there is activity on the GPIB interface. 'ERR' flashes whenever a computer interface error occurs, such as illegal command or out of range parameter is received.

The REM indicator is on whenever the SR780 is in a remote state (front panel locked out).

The SRQ indicator is on when the SR780 generates a service request. SRQ stays on until a GPIB serial poll is completed.

To help find program errors, the SR780 can display the interface buffers on the screen. This screen is accessed by <View Qs> in the [System] <Remote> menu. The last 256 characters received and transmitted by the SR780 are displayed.

Command Format

Communications with the SR780 uses ASCII characters. Commands may be in either UPPER or lower case. A command to the SR780 consists of a four character command mnemonic with optional ?, arguments if necessary, and a command terminator. The command, arguments and terminator may be separated by spaces. The terminator must be a linefeed <lf> or carriage return <cr> on RS232, or a linefeed <lf> or EOI on GPIB. No command processing occurs until a terminator is received. Commands function identically on GPIB and RS232 whenever possible. Command mnemonics beginning with an asterisk '*' are IEEE-488.2 (1987) defined common commands. These commands also function identically on RS232. Commands may require one or more parameters. Multiple parameters are separated by commas (,).

Multiple commands may be sent on one command line by separating them with semicolons (;).

There is no need to wait between commands. The SR780 has a 256 character input buffer and processes commands in the order received. If the buffer fills up, the SR780 will hold off handshaking on the GPIB and attempt to hold off handshaking on RS232. Similarly, the SR780 has a 256 character output buffer to store output until the host computer is ready to receive it. If either buffer overflows, both buffers are cleared and an error reported.

The present value of a particular parameter may be determined by querying the SR780 for its value. A query is formed by appending a question mark '?' to the command mnemonic and omitting the desired parameter from the command. Values returned by the SR780 are sent as a string of ASCII characters terminated by a carriage return <cr> on RS232 and by a line-feed <lf> on GPIB. If multiple query commands are sent on one command line (separated by semicolons, of course), the answers will be returned individually, each with a terminator.

Examples of Commands

TSLP 0 <lf>	Set the Trigger Slope to Positive
FCTR 1, 10E3 <lf>	Set the Center Frequency of DisplayB to 10000 Hz (10 kHz)
FCTR ? 1	Query the Center Frequency of DisplayB
*IDN ? <lf>	Query the Device Identification String
STRT <lf>	Start the measurement (same as [Start/Reset] key)

Command Synchronization

IFC (Interface Ready, bit 7) in the Serial Poll status signals that the SR780 is ready to receive and execute a command. When a command is received, this bit is cleared, indicating that command execution is in progress. No other commands will be processed until this command is completed. Commands received during this time are stored in the buffer to be processed later. Only GPIB serial polling will generate a response while a command is in progress. When all pending commands have executed, the IFC bit is set again. By checking IFC with serial polls, a host computer can ensure that all previously sent commands have finished before sending a new command.

Since most commands execute very quickly, the host computer does not need to continually check the IFC bit. Commands may be sent one after another and they will be processed immediately.

However, some commands, such as file and print/plot commands and data transfer operations, may require a long time to execute. In addition, the host program may need to check that these operations executed without error. In these cases, after the command is sent, the status should be queried.

When using the GPIB interface, serial polling may be used to check the IFC bit in the Serial Poll status while an operation is in progress. After the IFC bit becomes set, signaling the completion of the command, then the IERR bit may be checked to verify successful completion of the command.

If the RS232 interface is used, or serial polling is not available, then the `*STB?` query command may be used to read the Serial Poll status word. However, `*STB NEVER` returns the IFC bit set (since `*STB` is itself a command).

Since the SR780 processes one command at a time, status queries will not be processed until the previous operation is finished. Thus a response to a status query in itself signals that the previous command is finished. The query response may then be checked for various errors.

For example, the command line `FSAV 0; ERRS ? <lf>` will save the DisplayA data to disk and return the Error Status word when finished. The Disk Error bit may be checked to make sure that the FSAV (Display to Disk) command completed without error. Since the FSAV command may take a long time to execute, it is important that the host computer interface does not time out while waiting for the response to the `ERRS ?` query. In the case where the host interface times out before the `ERRS ?` response, the host program must wait before sending the `ERRS ?` query.

Data Synchronization

Changing measurement parameters often invalidates the display data. For example, changing FFT spans or resolution requires some time before new data taken with the new span or resolution is available. Another example is changing the FFT average mode while averaging is on. In this case, the average is re-started and some time is required before a new average is completed.

For these types of commands, simply waiting for IFC to be set does not ensure that the display data reflects the operation just completed. Before querying or saving the display data, the Display Status word needs to be queried until either NEW, AVG or STL is set indicating new data is available, average completed or new settled data is available. This will ensure that the display data has been updated since the previous operation.

Remember, these status bits are only reset when read. The status word needs to be cleared before waiting for the desired bits to become set.

For example, to change the span and wait until new data is available, a program might use the following procedure.

send (“*CLS; FSPN 0,6400”) **CLS clears all status words, FSPN changes the span of DisplayA to 6.4 kHz.*

query (“DSPS?”) *DSPS? reads the Display Status*

until NEWA and STLA are set *NEWA&STLA indicates new settled data is available at the new span.*

Command Context Errors

Commands which perform menu softkey functions are not allowed unless the corresponding softkey function is allowed. If the softkey is not available in the current context, either shown in gray or not displayed at all, then the corresponding set command is not allowed.

In general, softkeys are disabled for two reasons - the function is specifically not allowed in the current measurement context, or the function is only applicable for certain measurement groups.

For example, FFT <Start Frequency> is grayed when the measurement is full span. The FSTR set command is not allowed in this situation. However, the FSTR? query command is still allowed.

An example of group specific parameter are the commands which set Swept Sine parameters. These set commands are not allowed unless the measurement group is Swept Sine (just like the menu interface).

Example Program

An example program is included at the end of this chapter. This program is a good reference for writing your own programs to control the SR780.

Command Syntax

The four letter mnemonic (shown in CAPS) in each command sequence specifies the command. The rest of the sequence consists of parameters. Parameters shown in { } are not always required. Generally, parameters in { } are required to set a value in the SR780. Multiple parameters are separated by commas. Multiple commands may be sent on one command line by separating them with semicolons (;).

The present value of a parameter may be determined by sending a query command. Commands that may be queried have a question mark in parentheses (?) after the mnemonic. Commands that may ONLY be queried have a ? after the mnemonic. Commands that MAY NOT be queried have no ?. A query is formed by including the question mark ? after the command mnemonic and omitting the queried parameter from the command. The query parameters shown in { } are NOT sent with a query. The query returns the value of these parameters. Values are returned as a string of ASCII characters (unless otherwise noted).

Do NOT send () or { } as part of the command.

For example, the command sequence FSTR (?) d {, f} is used as follows.

```
FSTR 0, 1.024E3      Set the Start Frequency of DispA to 1024 Hz.
FSTR ? 0           Query the Start Frequency of DispA.
```

Variables are defined as follows.

d	display (0=DispA, 1=DispB, 2=Both Displays) d=2 is not allowed for queries.
i, j, k, l, m	integers
x, y	real numbers
f	frequency in Hz
s	text string

Commands to set values which may be different for each display require the d parameter. These values must be queried separately for each display (d=2 is not allowed for queries) even if the parameter is linked.

All numeric variables may be expressed in integer, floating point or exponential formats (i.e., the number five can be either 5, 5.0, or 0.5E1). Strings are sent as a sequence of ASCII characters.

Help

The detailed command list is available on screen by pressing [Help/Local] to enter the help system. Press [4] to show the command list. Commands are also cross referenced in the help about each key.

Things to Remember!

Output Interface (RS232 or GPIB)

All responses are directed to the interface selected by <Output To> in the [System] <Remote> menu, *regardless* of which interface received the query. Use the OUTX command to select the correct interface at the beginning of every program.

Active Display and Linking

Set commands which require a 'd' parameter specify DisplayA (0), DisplayB (1) or Both Displays (2) *without* regard to the active display or any parameter linking. Active display and linking are screen features which do *not* apply to interface commands.

Command Context Errors

Commands which perform softkey functions are not allowed unless the corresponding softkey function is allowed. If the softkey is not available, either shown in gray or not displayed at all, then the corresponding set command is not allowed.

Be careful to send commands in the correct order to avoid context errors. A good practice is to send the commands in the same order as programming the instrument using the softkeys.

Frequency Commands (FFT)

FSPN (?) d {, f}

The FSPN command sets (queries) the FFT frequency Span of display d. The parameter f is a real number of Hz. The available spans depend upon the FFT Base Frequency.

The set command changes the FFT Span to the available span closest to f Hz.

This command is valid only when the Measurement Group is FFT. The set command requires display d to be Live.

FLIN (?) d {, i}

The FLIN command sets (queries) the FFT Resolution of display d. The parameter i selects 100 (0), 200 (1), 400 (2) or 800 (3) lines. FLIN does not change the Span.

This command is valid only when the Measurement Group is FFT. The set command requires display d to be Live.

FBAS (?) d {, i}

The FBAS command sets (queries) the FFT Base Frequency of display d. The parameter i selects 100.0 kHz (0) or 102.4 kHz (1).

To set the Base Frequency, d must be 2 (both displays). There is only one Base Frequency for both displays. Changing the Base Frequency will affect all of the FFT and source frequency parameters.

This command is valid only when the Measurement Group is FFT. The set command requires at least one display to be Live.

FSTR (?) d {, f}

The FSTR command sets (queries) the FFT Start frequency of display d. The parameter f is a frequency (real number of Hz). Values of f which would cause the span to exceed the 0 to 102.4 (100.0) kHz range cause an error.

This command is valid only when the Measurement Group is FFT. The set command requires display d to be Live.

FCTR (?) d {, f}

The FCTR command sets (queries) the FFT Center frequency of display d. The parameter f is a frequency (real number of Hz). Values of f which would cause the span to exceed the 0 to 102.4 (100.0) kHz range cause an error.

This command is valid only when the Measurement Group is FFT. The set command requires display d to be Live.

5-26 Frequency Commands

FEND (?) d {, f}

The FEND command sets (queries) the FFT End frequency of display d. The parameter f is a frequency (real number of Hz). Values of f which would cause the span to exceed the 0 to 102.4 (100.0) kHz range cause an error.

This command is valid only when the Measurement Group is FFT. The set command requires display d to be Live.

UNST d

The UNST command unsettles the measurement of display d. The measurement is not actually perturbed by the UNST command. The settling status is set to unsettled and the full settling time of the measurement is required before the status returns to settled.

The measurement is unsettled by changing any one of several measurement parameters. For example, changing the input range or FFT span will unsettle the measurement. If the signal comes from an external source and is changed in such a way as to require the measurement to settle, it is convenient to use the UNST command and wait for settling to finish.

This command is valid only when the Measurement Group is FFT or Octave.

Frequency Commands (Octave)

OHIB (?) d {, f}

The OHIB command sets (queries) the Highest Band in the Octave measurement of display d. The parameter f is a frequency (real number of Hz). The Highest Band is specified to the nearest octave.

For 1 Channel octave analysis, the set command requires d=2.

This command is valid only when the Measurement Group is Octave. The set command requires display d to be Live.

OLOB (?) d {, f}

The OLOB command sets (queries) the Lowest Band in the Octave measurement of display d. The parameter f is a frequency (real number of Hz). The Lowest Band is specified to the nearest octave.

For 1 Channel octave analysis, the set command requires d=2.

This command is valid only when the Measurement Group is Octave. The set command requires display d to be Live.

ORES (?) d {, i}

The ORES command sets (queries) the Octave Resolution of display d. The parameter i selects 1/1 (0), 1/3 (1) or 1/12 (2) octave analysis. Changing the resolution may change the values of the Highest and Lowest Band for display d.

For 1 Channel octave analysis, the set command requires d=2.

This command is valid only when the Measurement Group is Octave. The set command requires display d to be Live.

OCHN (?) {i}

The OCHN command sets (queries) the Octave Channels. The parameter i selects 1 (0) or 2 (1) channel octave analysis.

This command is valid only when the Measurement Group is Octave. The set command requires both displays to be Live.

UNST d

The UNST command unsettles the measurement of display d. The measurement is not actually perturbed by the UNST command. The settling status is set to unsettled and the full settling time of the measurement is required before the status returns to settled.

The measurement is unsettled by changing any one of several measurement parameters. For example, changing the input range or FFT span will unsettle the measurement. If the signal comes from an external source and is changed in such a way as to require the measurement to settle, it is convenient to use the UNST command and wait for settling to finish.

5-28 Frequency Commands

This command is valid only when the Measurement Group is FFT or Octave.

Frequency Commands (Swept Sine)

SSTR (?) d {, f}

The SSTR command sets (queries) the swept sine Start frequency of display d. The parameter f is a frequency (real number of Hz). The range of f is 0.001 to 102.4E3. The set command requires d=2 (both displays).

This command is valid only when the Measurement Group is Swept Sine. The set command requires a display to be Live.

SSTP (?) d {, f}

The SSTP command sets (queries) the swept sine Stop frequency of display d. The parameter f is a frequency (real number of Hz). The range of f is 0.001 to 102.4E3. The set command requires d=2 (both displays).

This command is valid only when the Measurement Group is Swept Sine. The set command requires a display to be Live.

SSFR ?

The SSFR command queries which sweep point was the most recently measured. While a sweep is in progress, SSFR? returns values from 0 to the Number Of Points - 1.

After a sweep is started, SSFR? will not return 0 until the first point is measured. This may take some time if Source Ramping is On or if the Settling Time is very long.

This command is valid only when the Measurement Group is Swept Sine.

SRPT (?) d {, i}

The SRPT command sets (queries) the swept sine Repeat Mode of display d. The parameter i selects Single Shot (0) or Continuous (1). The set command requires d=2 (both displays).

This command is valid only when the Measurement Group is Swept Sine. The set command requires a display to be Live.

SSTY (?) d {, i}

The SSTY command sets (queries) the swept sine Sweep Type of display d. The parameter i selects Linear (0) or Logarithmic (1). The set command requires d=2 (both displays).

This command is valid only when the Measurement Group is Swept Sine. The set command requires a display to be Live.

SARS (?) d {, i}

The SARS command sets (queries) the swept sine Auto Resolution Mode of display d. The parameter i selects Off (0) or On (1). The set command requires d=2 (both displays).

5-30 Frequency Commands

This command is valid only when the Measurement Group is Swept Sine. The set command requires a display to be Live.

SNPS (?) d {, i}

The SNPS command sets (queries) the swept sine Number Of Points of display d. The parameter i is a number of points from 10 to 2047. The set command requires d=2 (both displays).

This command is valid only when the Measurement Group is Swept Sine. The set command requires a display to be Live.

SSKP (?) d {, i}

The SSKP command sets (queries) the swept sine Maximum Number Of Skips of display d. The parameter i is a maximum number of skips from 2 to 200. The set command requires d=2 (both displays).

This command is valid only when the Measurement Group is Swept Sine. The set command requires a display to be Live.

SFST (?) d {, x}

The SFST command sets (queries) the swept sine Faster Threshold of display d. The parameter x is a level from 0.01 to 3.0 (dB). The set command requires d=2 (both displays).

This command is valid only when the Measurement Group is Swept Sine. The set command requires a display to be Live.

SSLO (?) d {, x}

The SSLO command sets (queries) the swept sine Slower Threshold of display d. The parameter x is a level from 0.05 to 6.0 (dB). The set command requires d=2 (both displays).

This command is valid only when the Measurement Group is Swept Sine. The set command requires a display to be Live.

Display Setup Commands

MGRP (?) d {, i}

The MGRP command sets (queries) the Measurement Group of display d. The parameter i selects FFT (0), Octave (1) or Swept Sine (2).

Changing the Measurement Group changes the Frequency, Display Setup and Average menus. In addition, the Source and Capture menus may also change. The Measurement Group specific settings in these menus change to those last used with the new group. Parameters within these menus may only be changed with commands which are valid within the new group.

Both displays have the same Measurement Group. The set command requires display d to be Live.

MEAS (?) d {, i}

The MEAS command sets (queries) the Measurement of display d. The parameter i selects the measurement from the list below. Only those measurements available in the current Measurement Group are allowed.

Each measurement has an associated view. Changing the Measurement changes the View to the view last used with the new Measurement.

The set command requires display d to be Live.

<u>i</u>	<u>FFT Group</u> <u>Measurement</u>
0	FFT 1
1	FFT 2
2	Time 1
3	Time 2
4	Windowed Time 1
5	Windowed Time 2
6	Orbit
7	Coherence
8	Cross Spectrum
9	<F2/F1> Transfer Function Averaged
10	<F2>/<F1> Transfer Function of Averaged FFT's
11	Auto Correlation 1
12	Auto Correlation 2
13	Cross Correlation
14	Capture Buffer 1
15	Capture Buffer 2
16	FFT User Function 1
17	FFT User Function 2
18	FFT User Function 3
19	FFT User Function 4
20	FFT User Function 5

5-32 Display Setup Commands

	Octave Group
<u>i</u>	<u>Measurement</u>
21	Octave 1
22	Octave 2
23	Capture 1
24	Capture 2
25	Octave User Function 1
26	Octave User Function 2
27	Octave User Function 3
28	Octave User Function 4
29	Octave User Function 5

	Swept Sine Group
<u>i</u>	<u>Measurement</u>
30	Spectrum 1
31	Spectrum 2
32	Cross Spectrum
33	Transfer Function
34	Swept Sine User Function 1
35	Swept Sine User Function 2
36	Swept Sine User Function 3
37	Swept Sine User Function 4
38	Swept Sine User Function 5

A measurement should be setup by first choosing the Measurement Group, then the Measurement, then the View, then the Units. Finally, the display scale and references should be set.

VIEW (?) d {, i}

The VIEW command sets (queries) the View of display d. The parameter i selects the view from the list below.

Each view has associated units. Changing the View changes the Units to the units last used with the new view.

<u>i</u>	<u>View</u>
0	Log Magnitude
1	Linear Magnitude
2	Magnitude Squared
3	Real Part
4	Imaginary Part
5	Phase
6	Unwrapped Phase
7	Nyquist
8	Nichols

A measurement should be setup by first choosing the Measurement Group, then the Measurement, then the View, then the Units. Finally, the display scale and references should be set.

UNIT (?) d {, i}

The UNIT command sets (queries) the Units of display d. The parameter i selects the units from the list below.

Changing the Units changes the graph scale parameters (Y Max, Y Min, Y Mid, Y Center and Y/div).

<u>i</u>	<u>Units</u>
0	Vpk
1	Vrms
2	Vpk ²
3	Vrms ²
4	dBVpk (not for Nyquist View)
5	dBVrms (not for Nyquist View)
6	dBm (not for Nyquist View)
7	dBspl (EU=Pascals only)
	Phase Views Only
8	degrees
9	radians
	Transfer Function, Coherence, User Math Only
10	Units
11	dB

Only those units which are allowed for the present Measurement and View may be selected. In general, the first 7 choices are available (except for Nyquist View which only allows the first 4 choices). Transfer Function and Coherence are unitless so only dB and Units are available. Phase and Unwrapped Phase must select either degrees or radians.

A measurement should be setup by first choosing the Measurement Group, then the Measurement, then the View, then the Units. Finally, the display scale and references should be set.

YMAX (?) d {, x}

The YMAX command sets (queries) the Y Maximum (top reference) of display d. The parameter x is a real number in the display units. This command is not valid when the View is Nichols or Nyquist.

YMID (?) d {, x}

The YMID command sets (queries) the Y Midpoint (center reference) of display d. The parameter x is a real number in the display units. This command is not valid when the View is Nichols or Nyquist.

YMIN (?) d {, x}

The YMIN command sets (queries) the Y Minimum (bottom reference) of display d. The parameter x is a real number in the display units. This command is not valid when the View is Nichols or Nyquist.

5-34 Display Setup Commands

YDIV (?) d {, x}

The YDIV command sets (queries) the Y/Division scale of display d. The parameter x is a real number in the display units. This command is valid for all Views.

Changing the scale of a display may change the Y Max and Y Mid values. Always use a YMAX, YMID or YMIN command after the YDIV command.

XCEN (?) d {, x}

The XCEN command sets (queries) the X Center of display d. The parameter x is a real number in the display units. This command is only valid when the View is Nichols or Nyquist.

XDIV (?) d {, x}

The XDIV command sets (queries) the polar X/Division scale of display d. The parameter x is a real number in the display units. This command is only valid when the View is Nichols or Nyquist.

Changing the scale of a display may change the X Center value. Always use the XCEN command after the XDIV command.

YCEN (?) d {, x}

The YCEN command sets (queries) the Y Center of display d. The parameter x is a real number in the display units. This command is only valid when the View is Nichols or Nyquist.

Y2DV (?) d {, x}

The Y2DV command sets (queries) the polar Y/Division scale of display d. The parameter x is a real number in the display units. This command is only valid when the View is Nichols or Nyquist.

Changing the scale of a display may change the Y Center value. Always use the YCEN command after the Y2DV command.

XPAN (?) d {, i}

The XPAN command sets (queries) the Pan (translation) of display d. The parameter i is the left most displayed bin. This command is only valid when the display is Zoomed (expanded).

XZOM (?) d {, i}

The XZOM command sets (queries) the Zoom factor (X axis expand) of display d. The parameter i is the zoom factor (1-5). This command is not valid when the X axis is logarithmic or when the View is Nyquist or Nichols.

Display Options Commands

DISP (?) d {, i}

The DISP command sets (queries) the Display Update Mode of display d. The parameter i selects Off-Line (0) or Live (1).

Many parameters (Frequency, Measurement, etc.) are not adjustable for an Off-Line display. Commands which set these parameters for an Off-Line display are not valid.

DFMT (?) {i}

The DFMT command sets (queries) the Display Format. The parameter i selects Single (0) or Dual (1).

Use the ACTD command to select the active display in the Single format. In the Single format, the inactive display is still accessible via commands.

ACTD (?) i

The ACTD command sets the Active Display to display i. The parameter i selects DisplayA (0) or DisplayB (1).

Use the ACTD command to select the active display in the Single format. In the Single format, the inactive display is still accessible via commands.

XAXS (?) d {, i}

The XAXS command sets (queries) the X Axis Scale Type of display d. The parameter i selects Linear (0) or Logarithmic (1).

This command is valid only when display d is an FFT measurement with frequency as the X axis. FFT measurements with a time X axis (Time, WinTime, Correlation, Capture or User Time Function) always have a linear scale.

GRID (?) d {, i}

The GRID command sets (queries) the Grid On/Off Mode of display d. The parameter i selects Off (0) or On (1).

GDIV (?) d {, i}

The GDIV command sets (queries) the number of Grid Divisions of display d. The parameter i selects 8 (0), 10 (1), 12 (2) or 15 (3).

Changing the Grid Divisions changes the vertical scaling (Y/div) and horizontal scaling (X/div) (Nyquist and Nichols views).

PSDU (?) d {, i}

The PSDU command sets (queries) the PSD Units Mode of display d. The parameter i selects Off (0) or On (1).

5-36 Display Options Commands

TDRC (?) d {, i}

The TDRC command sets (queries) the Transducer Unit Convert Mode of display d. The parameter i selects Acceleration (0), Velocity (1) or Displacement (2).

This command is valid only when Engineering Units are On for display d AND the EU Label is an acceleration (m/s^2 or in/s^2), velocity (m/s or in/s) or displacement (m or in).

DBMR (?) {x}

The DBMR command sets (queries) the dBm Reference Impedance (for BOTH displays). The parameter x is a real value of Ohms. This affects the calculation of dBm units in both displays.

PHSL (?) d {, x}

The PHSL command sets (queries) the Phase Suppress Threshold of display d. The parameter x is a real magnitude squared value. This affects the calculation of phase for display d.

DDXW (?) d {, x}

The DDXW command sets (queries) the d/dx Window of display d. The parameter x is a percentage of the display width. This affects the calculation of d/dx and group delay for user math functions in display d.

Marker Commands

MRKR (?) d {, i}

The MRKR command sets (queries) the Marker Tracking of display d. The parameter i selects Off (0), On (1), Track (2) or Link (3).

MKMD (?) d {, i}

The MKMD command sets (queries) the Marker Mode of display d. The parameter i selects Normal (0), Harmonic (1), Sideband (2) or Band (3).

All modes are allowed in FFT measurement group.

Harmonic and Sideband are not allowed in Octave measurement group.

Harmonic, Sideband and Band are not allowed in Swept Sine measurement group.

MBIN d, i

The MBIN command moves the Marker or Marker Region of display d to bin i. Bin 0 is the left most bin in the display. The marker of each display must be moved separately (d=2 is not allowed).

A Spot marker will move to bin i. A marker region will be centered on bin i (if possible). The Normal marker will still seek the Max, Min or Mean within the region.

This command is not valid if the Marker of display d is Off.

MWFL d, i

The MWFL command moves the Waterfall Marker of display d to record i (in the Z axis). Record 0 is the most recent record in the display. The marker of each display must be moved separately (d=2 is not allowed).

This command is valid only if display d is a Waterfall and the measurement is paused. This command is not valid if the Marker of display d is Off.

MRKX ? d

The MRKX ? command queries the time, frequency or bin number of the marker position in display d. The returned value is always the absolute position of the marker, even when the on-screen marker is relative. The returned value has the same units as the first value shown in the Marker Position Bar.

This command is not valid if the Marker of display d is Off.

MRKB ? d

The MRKB ? command queries the marker bin number of display d. The value returned is the bin number of the marker. Bin 0 is the left most bin in the display.

This command is not valid if the Marker of display d is Off.

5-38 Marker Commands

MRKY ? d

The MRKY ? command queries the vertical axis data value at the marker position of display d. The returned value is always the absolute position of the marker, even when the on-screen marker is relative.

This command is not valid if the Marker of display d is Off.

MRKZ ? d

The MRKZ ? command queries the Z position at the marker position of display d.

If the display is a 2-D display (Nyquist or Nichols view), MRKZ? queries the horizontal axis data value at the marker position. The returned value is always the absolute position of the marker, even when the on-screen marker is relative. MRKY? queries the position along the vertical axis and MRKX? queries the time or frequency.

If the display is a waterfall, MRKZ? queries the Z-axis record number of the marker. Lower record numbers are more recent.

This command is not valid if the Marker of display d is Off.

MKMX d

The MKMX command performs Marker to Max on display d. (Same as [Marker Max] key). The marker of each display must be moved separately (d=2 is not allowed).

This command is not valid if the Marker of display d is Off.

MKMN d

The MKMN command performs Marker to Min on display d. (Same as [Marker Min] key). The marker of each display must be moved separately (d=2 is not allowed).

This command is not valid if the Marker of display d is Off.

MKCN d

The MKCN command performs Marker to Center on display d. (Same as [Marker Center] key). The center frequency of the FFT span is set to the marker frequency on display d. The span is decreased if necessary. The center of each display must be moved separately (d=2 is not allowed).

This command is only valid when the Measurement Group is FFT and display d is Live. This command is not valid if the Marker of display d is Off.

Marker Commands (Normal)

MSEK (?) d {, i}

The MSEK command sets (queries) the Normal Marker Seeks Mode of display d. The parameter i selects Max (0), Min (1) or Mean (2).

This command is only valid if the Marker Mode for display d is Normal.

MWID (?) d {, i}

The MWID command sets (queries) the Normal Marker Width of display d. The parameter i selects Spot (0), 1/2 division (1) or 1 division (2).

This command is only valid if the Marker Mode for display d is Normal.

MREL (?) d {, i}

The MREL command sets (queries) the Normal Marker Relative Mode of display d. The parameter i selects Off (0), Relative to Offset (1), Relative to Reference Display (2) or Relative to Other Display (3).

This command is only valid if the Marker Mode for display d is Normal.

MROX (?) d {, x}

The MROX command sets (queries) the X Offset for the Normal Marker of display d. The parameter x is a real number in display units.

This command is only valid if the Marker Mode for display d is Normal.

MROY (?) d {, x}

The MROY command sets (queries) the Y Offset for the Normal Marker of display d. The parameter x is a real number in display units.

This command is only valid if the Marker Mode for display d is Normal.

MXRL (?) d {, i}

The MXRL command sets (queries) the X Rel Mode for the Normal Marker of display d. The parameter i selects Absolute (Off) or Relative (On).

This command is only valid if the Marker Mode for display d is Normal.

MRON (?) d

The MRON command sets toggles the Normal Marker between Marker Rel Off and Marker Rel to Offset. This is similar to the [Marker Ref] key. MRON operates on a single display (d=2 is not allowed).

If Marker Rel is Off, MRON d sets the Normal Marker offsets (X and Y) to the current marker position and sets the Marker to Relative to Offset (relative marker readings).

If Marker Rel is Relative to Offset, MRON d sets the Marker Rel to Off (absolute marker readings).

5-40 Marker Commands

MRON? d returns 0 if Marker Rel is Off and 1 if Marker is Rel to Offset.

This command is only valid if the Marker Mode for display d is Normal.

Marker Commands (Harmonic)

HRMN (?) d {, i}

The HRMN command sets (queries) the Number of Harmonics for display d. The parameter i is a number of harmonics from 1 to 100.

This command is only valid if the Marker Mode for display d is Harmonic.

HDSP (?) d {, i}

The HDSP command sets (queries) the Harmonic and Sideband Marker Display for display d.

For Harmonic Marker, i=0 selects the Fundamental, i=1 selects 2xFundamental, etc. The maximum value of i is the Number of Harmonics.

For Sideband Marker, i=0 selects the Fundamental, i=-1 selects the first lower sideband, i=1 selects the first upper sideband. The maximum value of i plus or minus the Number of Sidebands. i<0 is valid only for Sideband marker.

This command is only valid if the Marker Mode for display d is Harmonic or Sideband.

HRDO (?) d {, i}

The HRDO command sets (queries) the Harmonic and Sideband Marker Readout for display d. The parameter i selects Absolute (0) or Relative to Fundamental (1).

This command is only valid if the Marker Mode for display d is Harmonic or Sideband.

HTHD ? d, i

The HTHD ? command queries the Total Harmonic Distortion for display d. The parameter i selects percent (0) or dB Relative to Fundamental (1) and is required.

This command is only valid if the Marker Mode for display d is Harmonic.

HPWR ? d

The HPWR ? command queries the Harmonic Power for display d. The returned value is a real value of Vrms.

This command is only valid if the Marker Mode for display d is Harmonic.

Marker Commands (Sideband)

SSEP (?) d {, f}

The SSEP command sets (queries) the Sideband Separation for display d. The parameter f is the sideband separation in Hz.

This command is only valid if the Marker Mode for display d is Sideband.

SDBN (?) d {, i}

The SDBN command sets (queries) the Number of Sidebands for display d. The parameter i is a number of sidebands from 1 to 50.

This command is only valid if the Marker Mode for display d is Sideband.

HDSP (?) d {, i}

The HDSP command sets (queries) the Harmonic and Sideband Marker Display for display d.

For Sideband Marker, i=0 selects the Fundamental, i=-1 selects the first lower sideband, i=1 selects the first upper sideband. The maximum value of i plus or minus the Number of Sidebands. i<0 is valid only for Sideband marker.

This command is only valid if the Marker Mode for display d is Harmonic or Sideband.

HRDO (?) d {, i}

The HRDO command sets (queries) the Harmonic and Sideband Marker Readout for display d. The parameter i selects Absolute (0) or Relative to Fundamental (1).

This command is only valid if the Marker Mode for display d is Harmonic or Sideband.

SPWR ? d, i

The SPWR ? command queries the Sideband Power for display d. The parameter i selects dB Relative to Fundamental (0) or Vrms (1) and is required.

This command is only valid if the Marker Mode for display d is Sideband.

Marker Commands (Band)

BMKL (?) d, i {, j}

The BMKL command sets (queries) the Band Left Bin for display d. The parameter i selects Upper (0) or Lower (1) band and j is the bin number (0 is the most left) and cannot exceed number of bins in the display.

This command is only valid if the Marker Mode for display d is Band.

BMKR (?) d, i {, j}

The BMKR command sets (queries) the Band Right Bin for display d. The parameter i selects Upper (0) or Lower (1) band and j is the bin number (0 is the most left) and cannot exceed number of bins in the display.

This command is only valid if the Marker Mode for display d is Band.

BEXC ? d {, i}

The BEXC command queries the Band Exclusion for display d. The parameter i selects none (0), 1from2 (1) or 2from1 (2).

This command is only valid if the Marker Mode for display d is Band.

BRAM ? d {, i}

The BEXC command queries the Band Ratio Mode for display d. The parameter i selects 2/1 (0) or 2/(1+2) (1).

This command is only valid if the Marker Mode for display d is Band.

BPWR ? d, i

The BPWR command queries the Band Power for display d. The parameter i selects Upper (0) or Lower (1) band power.

This command is only valid if the Marker Mode for display d is Band.

BRAT ? d, i

The BPWR command queries the Band Ratio for display d. The parameter i selects percent (0) or dB (1) band ratio.

This command is only valid if the Marker Mode for display d is Band.

Source Commands

SRCO (?) {i}

The SRCO command sets (queries) the Source On or Off. The parameter i selects Off (0) or On (1).

This command is not valid when the Measurement Group is Swept Sine.

STYP (?) {i}

The STYP command sets (queries) the Source Type. The parameter i selects Sine (0), Chirp (1), Noise (2) or Arbitrary (3).

When the Measurement Group is Swept Sine, the Source Type may not be changed and this command is not valid.

Sine Source Commands

S1FR (?) {f}

The S1FR command sets (queries) the Frequency of Sine Tone 1. The parameter *f* is a frequency in Hz.

This command is valid only when the Source Type is Sine.

S1AM (?) {x}

The S1AM command sets (queries) the Amplitude of Sine Tone 1. The parameter *x* is a real number of V.

This command is valid only when the Source Type is Sine.

SOFF (?) {x}

The SOFF command sets (queries) the Offset of the Sine Source. The parameter *x* is a real number of V.

This command is valid only when the Source Type is Sine.

S2FR (?) {f}

The S2FR command sets (queries) the Frequency of Sine Tone 2. The parameter *f* is a frequency in Hz.

This command is valid only when the Source Type is Sine.

S2AM (?) {x}

The S2AM command sets (queries) the Amplitude of Sine Tone 2. The parameter *x* is a real number of V.

This command is valid only when the Source Type is Sine.

Chirp Source Commands

CAMP (?) {x}

The CAMP command sets (queries) the Chirp Amplitude. The parameter x is a real number of mV.

This command is valid only when the Source Type is Chirp.

CBUR (?) {x}

The CBUR command sets (queries) the Chirp Burst Percentage. The parameter x is a percentage from 1 to 100.

This command is valid only when the Source Type is Chirp and the Measurement Group is FFT.

CSRC (?) {i}

The CSRC command sets (queries) the Source Display. The parameter i selects DisplayA (0) or DisplayB (1)

This command is valid only when the Source Type is Chirp or Noise and the Measurement Group is FFT.

Noise Source Commands

NAMP (?) {x}

The NAMP command sets (queries) the Noise Amplitude. The parameter x is a real number of mV.

This command is valid only when the Source Type is Noise.

NTYP (?) {i}

The NTYP command sets (queries) the Noise Type. The parameter i selects Bandlimited White (0), White (1) or Pink (2).

This command is valid only when the Source Type is Noise.

NBUR (?) {x}

The NBUR command sets (queries) the Noise Burst Percentage. The parameter x is a percentage from 1 to 100.

This command is valid only when the Source Type is Noise and the Measurement Group is FFT.

NPER (?) {x}

The NPER command sets (queries) the Noise Burst Source Period. The parameter x is a time from 4 ms to 1 ks.

This command is valid only when the Source Type is Noise and the Measurement Group is Octave.

CSRC (?) {i}

The CSRC command sets (queries) the Source Display. The parameter i selects DisplayA (0) or DisplayB (1)

This command is valid only when the Source Type is Chirp or Noise and the Measurement Group is FFT.

Arbitrary Source Commands

AAMP (?) {x}

The AAMP command sets (queries) the Arbitrary Source Amplitude. The parameter x is a percentage of full scale (1V).

This command is valid only when the Source Type is Arbitrary.

ARAT (?) {i}

The ARAT command sets (queries) the Arbitrary Source Playback Rate. The parameter i [0 .. 19] selects a rate equal to the maximum rate divided by 2 to the ith power. Thus i=0 selects the maximum rate and i=1 selects half the maximum rate.

This command is valid only when the Source Type is Arbitrary.

ASRC (?) {i}

The ASRC command sets (queries) the Arbitrary Source Buffer. The parameter i selects Arbitrary Waveform memory (0), Ch1 Capture (1) or Ch2 Capture (2). The selected buffer must contain data otherwise an error occurs.

This command is valid only when the Source Type is Arbitrary.

ASTR (?) {i}

The ASTR command sets (queries) the Arbitrary Source Start point. The parameter i is a point in the Arbitrary Waveform (either in Arbitrary memory or a Capture buffer).

This command is valid only when the Source Type is Arbitrary.

ALEN (?) {i}

The ALEN command sets (queries) the Arbitrary Source Length. The parameter i is the length in kPts in the Arbitrary Waveform (either in Arbitrary memory or a Capture buffer). i must be an even number from 2 to the length of the waveform.

This command is valid only when the Source Type is Arbitrary.

TARB i

The TARB command copies Trace i to the Arbitrary Waveform buffer. The Arbitrary Length is changed to 2 kPoints and the Arbitrary Source is change to Arb. Buffer. Trace i must contain FFT measurement data (usually a time record).

This command is valid only when the Source Type is Arbitrary.

Swept Sine Source Commands

SSAL (?) {i}

The SSAL command sets (queries) the Auto Level Reference. The parameter *i* selects Off (0), Channel 1 (1) or Channel 2 (2).

This command is valid only when the Measurement Group is Swept Sine.

SSAM (?) {x}

The SSAM command sets (queries) the Swept Sine Amplitude. The parameter *x* is a real number of mV.

This command is valid only when the Measurement Group is Swept Sine and Auto Level Reference is Off.

SSRF (?) {x}

The SSRF command sets (queries) the Swept Sine Ideal Reference. The parameter *x* is a real number of mV.

This command is valid only when the Measurement Group is Swept Sine and Auto Level Reference is Ch1 or Ch2.

SRMP (?) {i}

The SRMP command sets (queries) the Swept Sine Source Ramping. The parameter *i* selects Off (0) or On (1).

This command is valid only when the Measurement Group is Swept Sine.

SRAT (?) {x}

The SRAT command sets (queries) the Swept Sine Source Ramp Rate. The parameter *x* is ramp rate in V/s.

This command is valid only when the Measurement Group is Swept Sine.

SSUL (?) {x}

The SSUL command sets (queries) the Swept Sine Reference Upper Limit. The parameter *x* is a ratio in dB from 0.1 to 30.0 dB.

This command is valid only when the Measurement Group is Swept Sine and Auto Level Reference is Ch1 or Ch2.

SLL (?) {x}

The SLL command sets (queries) the Swept Sine Reference Lower Limit. The parameter *x* is a ratio in dB from -0.1 to -30.0 dB.

This command is valid only when the Measurement Group is Swept Sine and Auto Level Reference is Ch1 or Ch2.

SMAX (?) {x}

The SMAX command sets (queries) the Swept Sine Maximum Level. The parameter x is a real number of mV.

This command is valid only when the Measurement Group is Swept Sine and Auto Level Reference is Ch1 or Ch2.

Input Commands

ISRC (?) {i}

The ISRC command sets (queries) the Input Source. The parameter *i* selects Analog (0) or Capture (1).

Capture is not valid when the Measurement Group is Swept Sine.

I1MD (?) {i}

The I1MD command sets (queries) the Ch1 Input Mode. The parameter *i* selects A (single-ended) (0) or A-B (differential) (1).

I1GD (?) {i}

The I1GD command sets (queries) the Ch1 Input Grounding. The parameter *i* selects Float (0) or Ground (1).

I1CP (?) {i}

The I1CP command sets (queries) the Ch1 Input Coupling. The parameter *i* selects DC (0), AC (1) or ICP (2).

I1RG (?) {i}

The I1RG command sets (queries) the Ch1 Input Range. The parameter *i* ranges from -50 to +34 (dB) and must be even. If Ch1 AutoRange is On, the I1RG *i* command will turn Ch1 AutoRange Off and set the Ch1 Range to *i*.

A1RG (?) {i}

The A1RG command sets (queries) the Ch1 AutoRanging Off/On. The parameter *i* selects Off (Manual) (0) or On (AutoRanging) (1). If *i*=1 and Ch1 AutoRange is already On, a new AutoRange is performed.

I1AR (?) {i}

The I1AR command sets (queries) the Ch1 AutoRange Mode. The parameter *i* selects Normal (0) or Tracking (1).

I1AF (?) {i}

The I1AF command sets (queries) the Ch1 Anti-Aliasing Filter Off/On. The parameter *i* selects Off (0) or On (1).

I1AW (?) {i}

The I1AW command sets (queries) the Ch1 A-Weighting Filter Off/On. The parameter *i* selects Off (0) or On (1).

I2MD (?) {i}

The I2MD command sets (queries) the Ch2 Input Mode. The parameter *i* selects A (single-ended) (0) or A-B (differential) (1).

I2GD (?) {i}

The I2GD command sets (queries) the Ch2 Input Grounding. The parameter *i* selects Float (0) or Ground (1).

5-52 Input Commands

I2CP (?) {i}

The I2CP command sets (queries) the Ch2 Input Coupling. The parameter *i* selects DC (0), AC (1) or ICP (2).

I2RG (?) {i}

The I2RG command sets (queries) the Ch2 Input Range. The parameter *i* ranges from -50 to +34 (dB) and must be even. If Ch2 AutoRange is On, the I2RG *i* command will turn Ch2 AutoRange Off and set the Ch2 Range to *i*.

I2AR (?) {i}

The I2AR command sets (queries) the Ch2 AutoRange Mode. The parameter *i* selects Normal (0) or Tracking (1).

A2RG (?) {i}

The A2RG command sets (queries) the Ch2 AutoRanging Off/On. The parameter *i* selects Off (Manual) (0) or On (AutoRanging) (1). If *i*=1 and Ch2 AutoRange is already On, a new AutoRange is performed.

I2AF (?) {i}

The I2AF command sets (queries) the Ch2 Anti-Aliasing Filter Off/On. The parameter *i* selects Off (0) or On (1).

I2AW (?) {i}

The I2AW command sets (queries) the Ch2 A-Weighting Filter Off/On. The parameter *i* selects Off (0) or On (1).

IAOM (?) {i}

The IAOM command sets (queries) the Input Auto Offset Off/On. The parameter *i* selects Off (0) or On (1).

EU1M (?) {i}

The EU1M command sets (queries) the Ch1 Engineering Units Mode. The parameter *i* selects Off (0) or On (1).

EU1L (?) {i}

The EU1L command sets (queries) the Ch1 Engineering Units Label. The parameter *i* selects the unit label.

<i>i</i>	<u>Label</u>	<i>i</i>	<u>Label</u>
0	m/s ²	8	kg
1	m/s	9	lbs
2	m	10	N
3	in/s ²	11	dyne
4	in/s	12	Pas
5	in	13	bar
6	mil	14	USER
7	g		

EU1V (?) {x}

The EU1V command sets (queries) the Ch1 Engineering Units per Volt scale. The parameter x is real number of EU/Volt (EU's per Volt).

EU1U (?) {s}

The EU1U command sets (queries) the Ch1 User Label. The string s is the user label.

EU2M (?) {i}

The EU2M command sets (queries) the Ch2 Engineering Units Mode. The parameter i selects Off (0) or On (1).

EU2L (?) {i}

The EU2L command sets (queries) the Ch2 Engineering Units Label. The parameter i selects the unit label.

<u>i</u>	<u>Label</u>	<u>i</u>	<u>Label</u>
0	m/s ²	8	kg
1	m/s	9	lbs
2	m	10	N
3	in/s ²	11	dyne
4	in/s	12	Pas
5	in	13	bar
6	mil	14	USER
7	g		

EU2V (?) {x}

The EU2V command sets (queries) the Ch2 Engineering Units per Volt scale. The parameter x is real number of EU/Volt (EU's per Volt).

EU2U (?) {s}

The EU2U command sets (queries) the Ch2 User Label. The string s is the user label.

Input Playback Commands

ISTR (?) {i}

The ISTR command sets (queries) the Capture Playback Start point. The parameter *i* is a point in the Capture buffer.

This command is valid only when the Input Source is Playback.

ILEN (?) {i}

The ILEN command sets (queries) the Capture Playback Length. The parameter *i* is the length in kPts in the Capture buffer. *i* must be an even number from 2 to the length of the waveform.

This command is valid only when the Input Source is Playback.

IMOD (?) {i}

The IMOD command sets (queries) the Capture Playback Mode. The parameter *i* selects 1-Shot (0) or Circular (1).

This command is valid only when the Input Source is Playback.

ISPD (?) {i}

The ISPD command sets (queries) the Capture Playback Speed. The parameter *i* selects Normal (0) or Every Frame (1).

This command is valid only when the Input Source is Playback.

Trigger Commands

TMOD (?) {i}

The TMOD command sets (queries) the Trigger Mode. The parameter *i* selects Free Run (0), Auto Arm (1) or Manual Arm (2).

TSRC (?) {i}

The TSRC command sets (queries) the Trigger Source. The parameter *i* selects Ch1 (0), Ch2 (1), External (2), External TTL (3), Source (4) or Manual (5).

TLVL (?) {i}

The TSRC command sets (queries) the Trigger Level. The parameter *i* is an integer number of percent from -100 to 99.

TSLP (?) {i}

The TSRC command sets (queries) the Trigger Slope. The parameter *i* selects Rising (0) or Falling (1).

TDLA (?) {i}

The TDLA command sets (queries) the Trigger Delay A. The parameter *i* is a number of samples from -8000 to +100000.

This command is valid only when the Measurement Group is FFT.

TDLB (?) {i}

The TDLB command sets (queries) the Trigger Delay B. The parameter *i* is a number of samples from -8000 to +100000.

This command is valid only when the Measurement Group is FFT.

TARM

The TARM command Manually Arms the trigger. This command may not be queried.

STMD (?) {i}

The STMD command sets (queries) the Triggered Source Mode. The parameter *i* selects 1-Shot (0) or Continuous (1).

TMAN

The TMAN command Manually Triggers if armed. This command may not be queried.

Average Commands (FFT)

FAVG (?) d {, i}

The FAVG command sets (queries) the FFT Averaging Off/On for display d. The parameter i selects Off (0) or On (1).

This command is valid only when the Measurement Group is FFT. The set command requires display d to be Live.

FAVM (?) d {, i}

The FAVM command sets (queries) the FFT Averaging Mode for display d. The parameter i selects Vector (0), RMS (1) or Peak Hold (2).

This command is valid only when the Measurement Group is FFT. The set command requires display d to be Live.

FAVT (?) d {, i}

The FAVT command sets (queries) the FFT Averaging Type for display d. The parameter i selects Linear (0), Exponential (1), Fixed Length (2) or Continuous (3).

This command is valid only when the Measurement Group is FFT. The set command requires display d to be Live.

FAVN (?) d {, i}

The FAVN command sets (queries) the FFT Number of Averages for display d. The parameter i is a number of averages from 2 to 32767.

This command is valid only when the Measurement Group is FFT. The set command requires display d to be Live.

NAVG ? d

The NAVG command queries the Number of Averages completed for display d.

For linear averaging, the returned value is less than or equal to the FFT Number of Averages.

For exponential averaging, the returned value is the actual number of averages completed and eventually exceeds the FFT Number of Averages.

This command is valid in FFT and Octave Measurement Group.

FOVL (?) d {, x}

The FOVL command sets (queries) the FFT Time Record Increment for display d. The parameter x is a percentage up to 300.

This command is valid only when the Measurement Group is FFT. The set command requires display d to be Live.

FREJ (?) d {, i}

The FREJ command sets (queries) the FFT Overload Reject. The parameter i selects Off (0) or On (1). The set command requires d=2 (both displays).

This command is valid only when the Measurement Group is FFT. The set command requires a display to be Live.

PAVO (?) d {, i}

The PAVO command sets (queries) the Average Preview. The parameter i selects Off (0), Manual (1) or Timed (2). The set command requires d=2 (both displays).

This command is valid only when the Measurement Group is FFT. The set command requires a display to be Live.

PAVT (?) d {, x}

The PAVT command sets (queries) the Preview Time. The parameter x is a real number of seconds. The set command requires d=2 (both displays).

This command is valid only when the Measurement Group is FFT. The set command requires a display to be Live.

PAVA

The PAVA command accepts the previewed time record. The averages of both displays is updated to include the previewed time record.

Poll the NEWA and NEWB (New Data) status bits in the Display Status word to determine when each time record has been acquired. After accepting or rejecting the time record, the display reverts back to showing the actual measurement. This change does not set NEWA or NEWB but occurs upon receipt of the accept or reject command (or after a Preview Time).

This command is valid only when the Measurement Group is FFT. This command has no effect unless the previewed time records are displayed.

PAVR

The PAVR command rejects the previewed time record. The averages of both displays ignores the previewed time record.

Poll the NEWA and NEWB (New Data) status bits in the Display Status word to determine when each time record has been acquired. After accepting or rejecting the time record, the display reverts back to showing the actual measurement. This change does not set NEWA or NEWB but occurs upon receipt of the accept or reject command (or after a Preview Time).

This command is valid only when the Measurement Group is FFT. This command has no effect unless the previewed time records are displayed.

Average Commands (Octave)

OTYP (?) d {, i}

The OTYP command sets (queries) the Octave Averaging Type for display d. The parameter i selects Linear Time (0), Exponential Time (1), Peak Hold (2) or Equal Confidence (3).

For 1 Channel octave analysis, the set command requires d=2.

This command is valid only when the Measurement Group is Octave. The set command requires display d to be Live.

OTIM (?) d {, x}

The OTIM command sets (queries) the Octave Averaging Time for display d. The parameter x is the averaging time from 0.004 to 1000 seconds.

For 1 Channel octave analysis, the set command requires d=2.

This command is valid only when the Measurement Group is Octave. The set command requires display d to be Live.

NAVG ? d

The NAVG command queries the amount of averaging completed for display d.

The returned value is the amount of averaging completed in 4 ms increments. For example, a completed linear average of 1 second returns 250.

For exponential averaging, the returned value is the actual averaging completed and eventually exceeds the Octave Average Time.

This command is valid in FFT and Octave Measurement Group.

OCNF (?) d {, i}

The OCNF command sets (queries) the Octave Averaging Confidence Level for display d. The parameter i selects 0.125 dB (0), 0.25 dB (1), 0.5 dB (2), 1.0 dB (3) or 2.0 dB (4).

For 1 Channel octave analysis, the set command requires d=2.

This command is valid only when the Measurement Group is Octave. The set command requires display d to be Live.

OIMP (?) d {, i}

The OIMP command sets (queries) the Octave Power Bin for display d. The parameter i selects Total (0), Impulse (1), L (2) or Peak (3).

Peak power is not allowed if the Averaging Type is not Peak Hold.

Peak power is automatically selected if the Averaging Type is Peak Hold. Use the OTYP command to set Peak Hold averaging.

For 1 Channel octave analysis, the set command requires d=2.

This command is valid only when the Measurement Group is Octave. The set command requires display d to be Live.

OLAT (?) d {, i}

The OLAT command sets (queries) the Octave Linear Average Mode for display d. The parameter i selects Triggered (0) or Continuous (1).

The set command requires d=2 (both displays have the same mode).

This command is valid only when the Measurement Group is Octave. The set command requires a display to be Live.

Average Commands (Swept Sine)

SSTM (?) d {, x}

The SSTM command sets (queries) the Swept Sine Settle Time for display d. The parameter x is a settle time from 0.008 to 1000 seconds. The set command requires d=2 (both displays).

This command is valid only when the Measurement Group is Swept Sine. The set command requires a display to be Live.

SSCY (?) d {, i}

The SSCY command sets (queries) the Swept Sine Settle Cycles for display d. The parameter i is a number of cycles from 1 to 32767 seconds. The set command requires d=2 (both displays).

This command is valid only when the Measurement Group is Swept Sine. The set command requires a display to be Live.

SITM (?) d {, x}

The SITM command sets (queries) the Swept Sine Integration Time for display d. The parameter x is an integration time from 0.016 to 1000 seconds. The set command requires d=2 (both displays).

This command is valid only when the Measurement Group is Swept Sine. The set command requires a display to be Live.

SICY (?) d {, i}

The SICY command sets (queries) the Swept Sine Integration Cycles for display d. The parameter i is a number of cycles from 1 to 32767 seconds. The set command requires d=2 (both displays).

This command is valid only when the Measurement Group is Swept Sine. The set command requires a display to be Live.

User Math Commands

USRF (?) i {, j, k, l, ...}

USRO (?) i {, j, k, l, ...}

USRS (?) i {, j, k, l, ...}

The USRF, USRO and USRS commands define (query) the user functions for the FFT, Octave and Swept Sine Measurement Groups.

The parameter i selects a function number from 1 to 5.

The parameters j, k, l, ... are integers which are tokens for the available operands and operations. The tokens are listed below. The letters 'F', 'O' and 'S' indicate in which measurement groups each token is valid (FFT, Octave, Swept Sine).

For example, to define FFT User Function 3 as FFT(1)+FFT(2), the command USRF 3, 10, -1, 20 is used. If the function cannot be entered, a command execution error occurs.

<u>Operand/Operation</u>	<u>Token</u>	<u>Valid in Groups</u>
Mag(-101	F,O,S
Conj(-102	F,O,S
Real(-103	F,O,S
Imag(-104	F,O,S
Ln(-105	F,O,S
Exp(-106	F,O,S
FFT(-107	F
FFTu(-108	F
IFFT(-109	F
Sqrt(-110	F,O,S
Avg(-111	F
VecAvg(-112	F
jOmega(-113	F,S
Phase(-114	F,O,S
Mag ² (-115	F,O,S
AWt(-116	F,O,S
BWt(-117	F,O,S
CWt(-118	F,O,S
d/dx(-119	F,S
GrpDly(-120	F,S
[X/(1-X)](-121	F,O,S
+	-1	F,O,S
-	-2	F,O,S
x	-3	F,O,S
/	-5	F,O,S
(-6	F,O,S
)	-7	F,O,S

5-62 User Math Commands

FFT(1)	10	F
FFTa(1)	11	F
Time(1)	12	F
FFTu(1)	13	F
Oct(1)	14	O
Spec(1)	15	S
FFT(2)	20	F
FFTa(2)	21	F
Time(2)	22	F
FFTu(2)	23	F
Oct(2)	24	O
Spec(2)	25	S
Coherence	70	F
Auto_Corr(1)	71	F
Auto_Corr(2)	72	F
X_Corr	73	F
<F2>/<F1>	74	F
X_Spec	77	F
FFT2/FFT1	78	F
X_Spec	75	S
Trans_Fn	76	S
Trace1	41	F,O,S
Trace2	42	F,O,S
Trace3	43	F,O,S
Trace4	44	F,O,S
Trace5	45	F,O,S
Const1	51	F,O,S
Const2	52	F,O,S
Const3	53	F,O,S
Const4	54	F,O,S
Const5	55	F,O,S
j	60	F,O,S

USRC (?) i {, x, y}

The USRC command sets (queries) the real and imaginary parts of User Constant i. The parameter i selects a User Constant from 1 to 5.

The parameters x and y are floating point values for the real and imaginary parts.

Window Commands (FFT)

FWIN (?) d {, i}

The FWIN command sets (queries) the FFT Window for display d. The parameter i selects a window below.

<u>i</u>	<u>Window</u>
0	Uniform
1	Hanning
2	Flattop
3	BMH
4	Kaiser
5	Force
6	Exponential
7	User (query only)
8	[-T/2..T/2] (Correlation only)
9	[0..T/2] (Correlation only)
10	[-T/4..T/4] (Correlation only)

The Correlation windows may be selected only if display d is a live Correlation measurement.

The User window is selected by using the TRWI (Trace to Window) command. The parameter i cannot be 7 in a FWIN set command.

This command is valid only when the Measurement Group is FFT. The set command requires display d to be Live.

FWFL (?) d {, i}

The FWFL command sets (queries) the FFT Force Window Length for display d. The parameter i is a percentage of the time record from 1 to 100.

This command is valid only when the Measurement Group is FFT. The set command requires display d to be Live.

FWTC (?) d {, i}

The FWTC command sets (queries) the FFT Expo Window Time Constant for display d. The parameter i is a percentage of the time record from 5 to 1000.

This command is valid only when the Measurement Group is FFT. The set command requires display d to be Live.

TRWI d, i

The TRWI command copies the real part of stored Trace i to the User window of display d. Trace i must contain stored data.

This command is valid only when the Measurement Group is FFT. This command requires display d to be Live.

5-64 Window Commands

WTR d, i

The WTR copies the window of display d to the real part of Trace i. Trace i will have a length of 2048 points.

This command is valid only when the Measurement Group is FFT.

WSYM (?) d {, i}

The WSYM sets (queries) User Window Form for display d. The parameter i selects Non-Symmetric (0) or Symmetric (1).

This command is valid only when the Measurement Group is FFT and the window of display d is User.

Waterfall Commands

WDSP (?) d {, i}

The WDSP command sets (queries) the Waterfall Display Mode for display d. The parameter i selects Normal (0) or Waterfall (1).

This command is valid only when the Measurement Group is FFT or Octave.

WSTO (?) d {, i}

The WSTO command sets (queries) the Waterfall Storage for display d. The parameter i selects Off (0) or On (1).

This command is valid only when the Measurement Group is FFT or Octave.

WTOT (?) d {, i}

The WTOT command sets (queries) the Waterfall Total Count for display d. The parameter i is a number of records. If the allocated memory is too small for the requested number of records, an error occurs.

This command is valid only when the Measurement Group is FFT or Octave.

WAVA ? d

The WAVA command queries the number of records available in the waterfall buffer for display d.

Records are not stored in the buffer unless Waterfall Storage is on (Continuous or One Shot).

This command is valid only when the Measurement Group is FFT or Octave.

WFSK (?) d {, i}

The WFSK command sets (queries) the Waterfall Skip count for FFT measurements for display d. The parameter i is a number of records.

This command is valid only when the Measurement Group is FFT.

WOSK (?) d {, x}

The WOSK command sets (queries) the Waterfall Skip count for Octave measurements for display d. The parameter x is a time from .008 to 1000 s.

This command is valid only when the Measurement Group is Octave.

WVCT (?) d {, i}

The WVCT command sets (queries) the Waterfall View Count for display d. The parameter i is a number of records.

This command is valid only when the Measurement Group is FFT or Octave.

5-66 Waterfall Commands

WHIT (?) d {, i}

The WHIT command sets (queries) the Waterfall Trace Height for display d. The parameter i is a percentage [20..80] of the total display height.

This command is valid only when the Measurement Group is FFT or Octave.

WANG (?) d {, i}

The WANG command sets (queries) the requested Waterfall Angle for display d. The parameter i is a signed integer number of degrees [-75..+75]. The display will scroll as close to this angle as possible.

This command is valid only when the Measurement Group is FFT or Octave.

WFST (?) d {, i}

The WFST command sets (queries) the Waterfall Fast Angles for display d. The parameter i selects Off (0) or (On).

This command is valid only when the Measurement Group is FFT or Octave.

WTHR (?) d {, i}

The WTHR command sets (queries) the Waterfall Threshold for display d. The parameter i is a percentage of the full scale trace height.

This command is valid only when the Measurement Group is FFT or Octave.

WHID (?) d {, i}

The WHID command sets (queries) the Waterfall Hidden Lines for display d. The parameter i selects Invisible (0) or Visible (1).

This command is valid only when the Measurement Group is FFT or Octave.

WREV (?) d {, i}

The WREV command sets (queries) the Waterfall Paused Drawing for display d. The parameter i selects Normal (Newest at Top) (0) or Reversed (Oldest at Top) (1).

This command is valid only when the Measurement Group is FFT or Octave.

WTRC d, i, j

The WTRC command saves waterfall record j [0 is most recent, 1 is next, etc.] from display d to Trace i [1..5].

This command is valid only when the Measurement Group is FFT or Octave and the measurement is paused with waterfall storage on. If there is no record j, then an error occurs.

WSLC d, i, j

The WSLC command saves the waterfall time slice of bin j [0 is left most on x axis] from display d to Trace i [1..5].

This command is valid only when the Measurement Group is FFT or Octave and the measurement is paused with waterfall storage on. If there is no bin j , then an error occurs.

Capture Commands

CCHN (?) {i}

The CCHN command sets (queries) the Capture Channels. The parameter *i* selects Ch1 (0), Ch2 (1) or Ch1+Ch2 (2).

This command is valid only when the Measurement Group is FFT or Octave and the Input Source is Analog and the Source is not Arbitrary playback from Capture.

CMOD (?) {i}

The CMOD command sets (queries) the Capture Mode. The parameter *i* selects 1-Shot (0) or Continuous (1).

This command is valid only when the Measurement Group is FFT or Octave and the Input Source is Analog and the Source is not Arbitrary playback from Capture.

CLEN (?) {i}

The CLEN command sets (queries) the Capture Length. The parameter *i* is a length in kPts per channel. *i* must be an even number from 2 to the maximum allocated memory.

This command is valid only when the Measurement Group is FFT or Octave and the Input Source is Analog and the Source is not Arbitrary playback from Capture.

CRAT (?) {i}

The CRAT command sets (queries) the Capture Rate. The parameter *i* [0 .. 19] selects a rate equal to the maximum rate divided by 2 to the *i*th power. Thus *i*=0 selects the maximum rate and *i*=1 selects half the maximum rate.

This command is valid only when the Measurement Group is FFT or Octave and the Input Source is Analog and the Source is not Arbitrary playback from Capture.

CPAN (?) {i}

The CPAN command sets (queries) the Capture Auto Pan. The parameter *i* selects Off (0) or On (1).

CSTR

Same as [Start Capture] key. Capture memory must already be allocated. The Input Source cannot be Playback and the Source cannot be Arbitrary playback from Capture.

CSTP

Same as [Stop Capture] key. This command has no effect if Capture is not in progress.

Memory Allocation Commands

MMEM ?

The MMEM command queries the Total Available Memory for Capture, Waterfall and Arbitrary Waveform. MMEM ? returns the total number of memory blocks (2 kPts/block) in the instrument.

MALC i, j, k

The MALC command sets the Memory Allocation to i blocks for Capture, j blocks for Waterfall and k blocks for Arbitrary Waveform. The sum of $i+j+k$ cannot exceed the Total Available Memory.

The MALC command automatically confirms the allocation.

Data Table Commands

DTBL (?) d {, i}

The DTBL command sets (queries) the Data Table for display d. The parameter i selects Off (0) or On (1).

If the Data Table is On for both displays, use the ACTD command to select the active display. Only the Data Table of the active display may be edited or queried.

DMAX (?) d {, i}

The DMAX command sets (queries) the Data Table Length for display d. The parameter i is a last line number in the table up to 199.

The DMAX ? command queries the last line number in the table.

The DMAX d, i command sets the last line number in the table to i. If i is greater than the current last line number, new entries are created up to line i. These new entries use the current marker position as their X position. If the value of i is less than the current last line number, an error is returned. To remove entries from the table, use the DDLT command.

This command is valid only if the Data Table for display d is On and display d is the active display. Use the ACTD command to select the active display. Only the Data Table of the active display may be edited or queried.

DINS d, i {, j}

The DINS command sets (queries) the X-Axis bin number for line number i in the Data Table for display d. The parameter i selects the line number. If the value of i is greater than the last line number, an error is returned. The parameter j is the X axis bin number of line i. Bin 0 is the leftmost bin in the display. If there is no bin j in the display, an error occurs.

This command is valid only if the Data Table for display d is On and display d is the active display. Use the ACTD command to select the active display. Only the Data Table of the active display may be edited or queried.

DDLT d, i

The DDLT command deletes line number i. The value of i may not exceed the last line number in the table. The remaining lines are renumbered sequentially. The Data Table can not be erased completely. The last remaining line may not be deleted.

This command is valid only if the Data Table for display d is On and display d is the active display. Use the ACTD command to select the active display. Only the Data Table of the active display may be edited or queried.

DCLR d

The DCLR command clears the Data Table for display d. The Data Table can not be erased completely. The last remaining line may not be deleted.

This command is valid only if the Data Table for display *d* is On and display *d* is the active display. Use the ACTD command to select the active display. Only the Data Table of the active display may be edited or queried.

DTRD ? d {, i}

The DTRD ? command queries the Data Table measurement results for display *d*.

The DTRD ? d command queries the entire table. The data is returned in the form X0,Y0,X1,Y1,X2,Y2 ... Xn,Yn[lf] where Xn,Yn are the last entries in the table (index *n*). Any table entry not within the current measurement span returns the value -1.0E-34 for both X and Y.

The DTRD ? d, i command queries the X and Y values for line *i* only. The data is returned X, Y [lf]. If the table entry is not within the current measurement span, the values -1.0E-34 are returned for both X and Y.

This command is valid only if the Data Table for display *d* is On and display *d* is the active display. Use the ACTD command to select the active display. Only the Data Table of the active display may be edited or queried.

Limit Test Commands

LSON (?) d {, i}

The LSON command sets (queries) the Limit Segments Display for display d. The parameter i selects Hide (0) or Show (1).

LTST (?) d {, i}

The LTST command sets (queries) the Limit Testing for display d. The parameter i selects Off (0) or On (1).

LALM (?) d {, i}

The LALM command sets (queries) the Limit Fail Alarm for display d. The parameter i selects Off (0) or On (1).

LFAL ? d

The LFAL ? command queries the result of the most recently completed limit test of display d. If the test passed, 0 is returned. If the test failed, 1 is returned.

LCLR d

The LCLR command clears the Limit Segments for display d. All defined limit segments for display d are erased. The limits for each display are cleared separately (d=2 is not allowed).

This command should always be sent before defining any limit segments. Limit segments may not be defined or edited after the Measurement or Measurement Group is changed until LCLR clears the existing segments.

LMAX (?) d {, i}

The LMAX command sets (queries) the Last Limit Segment Number for display d. The parameter i is a last limit segment number from 0 to 199. The set command is not valid for d=2 (both displays).

The LMAX ? command queries the last limit segment number.

The LMAX d, i command sets the last limit segment number to i. If i is greater than the current last limit segment number, new entries are created up to line i. These entries simply follow the last limit segment. If the value of i is less than the last line number, an error is returned. To remove entries from the table, use the LDLT command.

This command also sets Limit Segments to Show.

LSEG (?) d, i {, j, x0, y0, x1, y1}

The LSEG command sets (queries) the Endpoints and Type of limit segment i for display d. The parameter i selects the limit segment number from 0 to the last segment. If i exceeds the last segment number (as set by LMAX), an error is reported.

The segments are defined separately for each display. The set command is not valid for d=2 (both displays).

The parameter *j* selects Upper (0) or Lower (1) limit. The parameters *x0* and *y0* are the coordinates of the limit start (X0,Y0). The parameters *x1* and *y1* are the coordinates of the limit end (X1,Y1). *x0*, *y0*, *x1* and *y1* are real numbers in the display units.

The LSEG ? *d*, *i* command queries the endpoints and type of limit segment *i*. The data is returned *j*, *f1*, *f2*, *y1*, *y2*[*lf*].

The LSEG *d*, *i*, *j*, *x0*, *y0*, *x1*, *y1* command sets the endpoints of segment *i* to *x0*, *y0* and *x1*, *y1* and the type to Upper (*j*=0) or Lower (*j*=1).

This command also sets Limit Segments to Show.

LDLT *d*, *i*

The LDLT command deletes Limit Segment Number *i* for display *d*. The value of *i* may not exceed the last limit segment number. The remaining segments are renumbered sequentially. This command is not valid for *d*=2 (both displays).

This command also sets Limit Segments to Show.

LSFT *d*, *x*

The LSFT command shifts all Limit Segments for display *d*. The parameter *x* is real number. The Y coordinates of all segments are shifted by *x* (in display units). This command is not valid for *d*=2 (both displays).

This command also sets Limit Segments to Show.

Marker Statistics Commands

MSAO (?) d {, i}

The MSAO command sets (queries) the Marker Statistics On or Off for display d. The parameter i selects Off (0) or On (1). The set command requires d=2 (both displays).

When Marker Statistics are On, the various statistical quantities are updated whenever new data is available on the display. The accumulation of the statistical quantities continues even when the Marker Statistics menu is not displayed.

MSRS

The MSRS command resets and starts the accumulation of marker statistics. The various quantities are reset to zero and the accumulation of marker statistics begins.

MSAA ?

The MSAA ? command queries Max for the Display A Marker.

MSIA ?

The MSIA ? command queries Min for the Display A Marker.

MSEA ?

The MSEA ? command queries Mean for the Display A Marker.

MSSA ?

The MSSA ? command queries Standard Deviation for the Display A Marker.

MSAB ?

The MSAB ? command queries Max for the Display B Marker.

MSIB ?

The MSIB ? command queries Min for the Display B Marker.

MSEB ?

The MSEB ? command queries Mean for the Display B Marker.

MSSB ?

The MSSB ? command queries Standard Deviation for the Display B Marker.

Exceedance Statistics Commands

ESTR (?) {i}

The ESTR command sets (queries) the Exceedance Start Index (for both displays). The parameter *i* is a waterfall index [0..].

This command is valid only when the Measurement Group is FFT or Octave.

ESTP (?) {i}

The ESTP command sets (queries) the Exceedance Stop Index (for both displays). The parameter *i* is a waterfall index [0..]. Remember, the records are numbered starting from 0. The last record is the number of stored records minus one. The exceedance calculation can not proceed if the stop index is greater than the number of records stored in the waterfall buffer minus one.

This command is valid only when the Measurement Group is FFT or Octave.

EPCT (?) {i}

The EPCT command sets (queries) the Exceedance Centile (for both displays). The parameter *i* is a centile from 1 to 99.

This command is valid only when the Measurement Group is FFT or Octave.

EXCE d, i

The EXCE command starts the exceedance centile calculation for display *d*. The parameter *i* selects a Trace [1..5] to store the result.

Display *d* must be paused or done with waterfall storage on and records stored in the waterfall buffer. Waterfall display is not required to be on.

The result is stored in a data trace and has the same measurement type as the waterfall measurements.

This command is valid only when the Measurement Group is FFT or Octave.

Disk Commands

FNAM (?) {s}

The FNAM command sets (queries) the Save/Recall File Name. All save and recall disk operations use the name specified by this command. Be sure to use the FNAM s command before any file operation commands.

For example, the “FNAM MYDATA.DAT” command sets the file name to MYDATA.DAT. DOS file name conventions must be followed, i.e. file names are 8 characters or less with an optional extension of up to 3 characters. If the extension is omitted, the SR780 uses default extensions.

File access is to the current directory.

FDIR (?) {s}

The FDIR command sets (queries) the Save/Recall File Directory. All save and recall disk operations use the directory specified by this command. Be sure to use the FDIR s command before any file operation commands.

‘FDIR DIRNAME’ looks within the current directory for a sub-directory called DIRNAME. If it exists, the current directory is changed to DIRNAME. FDIR moves down a directory path one level at a time. Use multiple FDIR commands to move down a directory path.

‘FDIR ..’ moves up one directory towards the root. ‘FDIR \’ sets the current directory to the root.

Only the last directory in the path is displayed in the menu box.

MDIR s

The MDIR command creates directory s within the current directory.

For example, the “MDIR TODAY” command creates the sub-directory TODAY within the current directory. DOS file conventions must be followed. Use FDIR to set the current directory.

FXST ? s

The ‘FXST ? FNAME’ query returns a 1 if the file FNAME exists in the current directory. 0 is returned if there is no file (or subdirectory) named FNAME in the current directory.

Wild cards (* and ?) are not allowed in the file name. The volume label and sub-directories are treated the same as actual files.

FREE ?

The FREE ? query returns the number of bytes available on the disk.

FRST ?

The FRST ? query returns the first entry in the current directory. The entire entry string is returned, "filename.ext, NNN, m/d/y, h:m:s" where NNN=file size, m/d/y=creation date and h:m:s=creation time.

Use FRST? to reset the catalog file pointer and then repeat FNXT? to query the rest of the directory entries.

FNXT ?

The FNXT ? query returns the next entry in the current directory. The entire entry string is returned, "filename.ext, NNN, m/d/y, h:m:s" where NNN=file size, m/d/y=creation date and h:m:s=creation time. FNXT? returns the string "*" to signify that there are no more entries.

Use FRST? to reset the catalog file pointer and then repeat FNXT? to query the rest of the directory entries until "*" is returned.

FSAV d

The FSAV command saves display d data to disk. The file name is specified by FNAM and the directory is specified by FDIR.

FRCL d

The FRCL command recalls data from disk to display d. Display d will be set Off-Line. The file name is specified by FNAM and the directory is specified by FDIR.

SSAV

The SSAV command saves the instrument settings to disk. The file name is specified by FNAM and the directory is specified by FDIR.

SRCL i

The SRCL command recalls the instrument settings from disk. The individual bits of integer i determine which parameter groups are recalled.

<u>bit</u>	<u>Parameter Group</u>
0	Measurements
1	Sources
2	Analysis
3	Inputs/Triggers
4	DRAM Settings
5	General System
6	Macros

If a bit is 0, the corresponding group IS NOT recalled. If a bit is 1, the corresponding group IS recalled. To determine the value of i, start with i=0. For each bit which is 1, add 2 raised to the bit number. For example, SRCL 127 recalls all groups. SRCL 17 recalls only the Measurements ($2^0=1$) and DRAM Settings ($2^4=16$).

5-78 Disk Commands

TSAV i

The TSAV command saves Trace i data to disk. The file name is specified by FNAME and the directory is specified by FDIR.

TRCL i

The TRCL command recalls data from disk to Trace i. The file name is specified by FNAME and the directory is specified by FDIR.

DNAM (?) {s}

The DNAM command sets (queries) the Upkeep File Name. The Delete File function will destroy this file! Be sure to use the DNAM s command before any file delete command.

For example, the “DNAM MYDATA.DAT” command sets the file name to MYDATA.DAT. DOS file name conventions must be followed, i.e. file names are 8 characters or less with an optional extension of up to 3 characters. The extension is NOT automatically supplied.

File access is to the current directory.

DELF

The DELF command deletes the file specified by the Upkeep File Name from the current directory. The file name is specified by DNAM and the directory is specified by FDIR.

DELD

The DELD command deletes the current directory. The directory must be empty otherwise no action is taken. If the directory is deleted, the current directory is changed to the directory one level closer to the root. The current directory is specified by FDIR.

Output Commands

POUT (?) {i}

The POUT command sets (queries) the [Print Screen] hardkey assignment. The parameter *i* selects Bitmap/Print (0), Vector/Plot (1) or ASCII Dump (2).

PDST (?) {i}

The PDST command sets (queries) the Print/Plot/Dump Destination. The parameter *i* selects Disk File (0), Centronics Printer Port (1), RS232 Serial Port (2) or GPIB Port (3).

PFIL (?) {i}

The PFIL command sets (queries) the Disk File Start Number. Print/Plot/Dump to disk automatically numbers the disk file names starting with the File Start Number. The parameter *i* is an integer up to 4 digits.

The PFIL ? command queries the next file number to be used.

DUMP

The DUMP command dumps the data in the active display in ASCII format to the selected Destination (Interface or Disk). The data is written *f,y,x[cr]* with the data for each point on a single line. *f* is the frequency or time value, *y* is the y-axis value and *x* is the x-axis value (if necessary)

PRNT

The PRNT command prints the screen using the selected Bitmap/Printer type and Destination. All other operations are disabled until printing is completed.

PRTP (?) {i}

The PRTP command sets (queries) the Bitmap/Printer type. The parameter *i* selects a type below.

<i>i</i>	<u>Printer Type</u>
0	Epson FX
1	HP PCL
2	HP Small PCL
3	PCX 2 bit (file)
4	GIF (file)
5	PCX 8 bit (file)

PSCR (?) {i}

The PSCR command sets (queries) what portion of the screen to print. The parameter *i* selects Graphs Only (0), Menu Only (1), Status Indicators Only (2) or All (3).

This only affects printing. Plotting only plots the display graphs.

PBRI (?) {i}

The PBRI command sets (queries) the print density of highlighted areas. The parameter *i* selects White (0), 6% (1), 12% (2), 25% (3), 50% (4) or Black (5).

5-80 Output Commands

PDIM (?) {i}

The PDIM command sets (queries) the print density of normal areas. The parameter *i* selects White (0), 6% (1), 12% (2), 25% (3), 50% (4) or Black (5).

PBLK (?) {i}

The PBLK command sets (queries) the print density of black text. The parameter *i* selects Black (0) or White (1).

PGRF (?) {i}

The PGRF command sets (queries) the graph print mode. The parameter *i* selects Black on White (0) or White on Black (1).

PLOT

The PLOT command plots the graph displays using the selected Vector/Plotter type and Destination. All other operations are disabled until plotting is completed.

PLTP (?) {i}

The PLTP command sets (queries) the Vector/Plotter type. The parameter *i* selects HPGL (0) or PostScript (1).

PLTA (?) {i}

The PLTA command sets (queries) the Plotter GPIB Address. The parameter *i* ranges from 0 to 30 and should agree with the address of the plotter in use.

PCIC (?) {i}

The PCIC command sets (queries) the GPIB Control mode. The parameter *i* selects Host (0) or SR780 (1).

PLTX (?) {i}

The PLTX command sets (queries) the Plotter Text Pen Number. The parameter *i* is a pen number from 1 to 8.

PLGD (?) {i}

The PLGD command sets (queries) the Plotter Grid Pen Number. The parameter *i* is a pen number from 1 to 8.

PLTR (?) {i}

The PLTR command sets (queries) the Plotter Trace Pen Number. The parameter *i* is a pen number from 1 to 8.

PLMK (?) {i}

The PLMK command sets (queries) the Plotter Marker Pen Number. The parameter *i* is a pen number from 1 to 8.

NOTE i, j {, k, l, m, s}

The NOTE command defines a Display Note. The parameter *i* selects a Note from 0 to 9. The parameter *j* makes the note Not Visible (0) or Visible (1). To turn a Note On and Off, use the NOTE *i, j* command.

The parameter *k* puts the note in Display A (0) or Display B (1). The parameters *l* and *m* are the Text X and Text Y position from 0 to 100. The string *s* is the note text. The parameters *k*, *l*, *m* and *s* must always be sent together.

System Commands

OUTX (?) {i}

The OUTX command sets (queries) the Output Interface. The parameter i selects GPIB (0) or RS232 (1).

The OUTX i command should always be sent at the start of any program to direct query responses to the correct interface.

OVRM (?) {i}

The OVRM command sets (queries) the GPIB Override Remote mode. The parameter i selects No (0) or Yes (1). When Override Remote is set to Yes, the front panel is not locked out when the unit is in the REMOTE state.

KCLK (?) {i}

The KCLK command sets (queries) the Key Click Off/On. The parameter i selects Off (0) or On (1).

ALRM (?) {i}

The ALRM command sets (queries) the Alarms Off/On. The parameter i selects Off (0) or On (1).

ALRT (?) {i}

The ALRT command sets (queries) the Alarms Volume. The parameter i selects Quiet (0) or Noisy (1).

ADON (?) {i}

The ADON command sets (queries) the Done Volume. The parameter i selects Quiet (0) or Noisy (1).

AOVL (?) {i}

The AOVL command sets (queries) the Audible Overload. The parameter i selects Off (0) or On (1).

SAVR (?) {i}

The SAVR command sets (queries) the Screen Saver Off/On. The parameter i selects Off (0) or On (1).

SDLY (?) {i}

The SDLY command sets (queries) the Screen Saver Delay. The parameter i is a delay in minutes from 1 to 59.

FFMT (?) {i}

The FFMT command sets (queries) the Frequency Format. The parameter i selects Exact Bin (0) or Rounded (1).

TIME (?) {i, j, k}

The TIME command sets (queries) the System Time.

The TIME ? command queries the time. A string of the form “HH:MM:SS” is returned.

The TIME i, j, k command sets the time to i [0..23] hours, j [0..59] minutes and k [0..59] seconds. The parameters i, j and k must all be sent.

DATE (?) {i, j, k}

The DATE command sets (queries) the System Date.

The DATE ? command queries the date. A string of the form “MM/DD/YY” is returned.

The DATE i, j, k command sets the date to i [1..12] month, j [1..31] day and k [0..99] year. The parameters i, j and k must all be sent.

Front Panel Commands

ACTD (?) i

The ACTD command sets the Active Display to display i. The parameter i selects DisplayA (0) or DisplayB (1).

Use the ACTD command to select the active display in the Single format. In the Single format, the inactive display is still accessible via commands.

STRT

The STRT command starts the measurement. Any average in progress is reset and started over. If the measurement is paused, STRT starts the measurement over.

This function is the same as pressing the [Start/Reset] key.

PAUS

If the measurement is already in progress, PAUS pauses the measurement.

If the measurement is paused, PAUS has no effect.

This function is similar to pressing the [Pause/Cont] key.

CONT

If the measurement is paused, CONT continues the measurement.

If the measurement is running, CONT has no effect.

This function is similar to pressing the [Pause/Cont] key.

UNST d

The UNST command unsettles the measurement of display d. The measurement is not actually perturbed by the UNST command. The settling status is set to unsettled and the full settling time of the measurement is required before the status returns to settled.

The measurement is unsettled by changing any one of several measurement parameters. For example, changing the input range or FFT span will unsettle the measurement. If the signal comes from an external source and is changed in such a way as to require the measurement to settle, it is convenient to use the UNST command and wait for settling to finish.

This command is valid only when the Measurement Group is FFT or Octave.

SVTR d, i

The SVTR command saves display d to Trace i.

RCTR d, i

The RCTR command recalls Trace i to display d. If Trace i does not have data, then an error occurs.

SVRF d, i

The SVRF command saves the Reference Display of display d to Trace i.

RCRF d, i

The RCRF command recalls Trace i to the Reference Display of display d. If Trace i does not have data or is not compatible with the active display measurement, an error occurs. For example, if Trace i is a time record, it cannot be recalled into the Reference Display of an FFT measurement.

PRNT

The PRNT command prints the screen using the selected Printer Type and Destination. All other operations are disabled until printing is completed.

PLOT

The PLOT command plots the screen using the selected Plotter Type and Destination. All other operations are disabled until plotting is completed.

DUMP

The DUMP command dumps the data in the active display in ASCII format to the selected Destination (Interface or Disk). The data is written f,y,x[cr] with the data for each point on a single line. f is the frequency or time value, y is the y-axis value and x is the x-axis value (if necessary)

ASCL d

The ASCL command AutoScales display d. This is the same as pressing the [Auto Scale A] or [Auto Scale B] keys. The displays are AutoScaled separately (d=2 is not allowed).

A1RG (?) {i}

The A1RG command sets (queries) the Ch1 AutoRanging Off/On. The parameter i selects Off (Manual) (0) or On (AutoRanging) (1). If i=1 and Ch1 AutoRange is already On, a new AutoRange is performed.

A2RG (?) {i}

The A2RG command sets (queries) the Ch2 AutoRanging Off/On. The parameter i selects Off (Manual) (0) or On (AutoRanging) (1). If i=1 and Ch2 AutoRange is already On, a new AutoRange is performed.

MRON d

The MRON command sets the Normal Marker offsets (X and Y) to the current marker position and sets the Marker Relative to Offset (if Marker Rel was Off). This is similar to the [Marker Ref] key.

This command is only valid if the Marker Mode for display d is Normal.

MKMX d

The MKMX command performs Marker to Max on display d. (Same as [Marker Max] key).

This command is not valid if the Marker of display d is Off.

5-86 Front Panel Commands

MKMN d

The MKMN command performs Marker to Min on display d. (Same as [Marker Min] key).

This command is not valid if the Marker of display d is Off.

MKCN d

The MKCN command performs Marker to Center on display d. (Same as [Marker Center] key). The center frequency of the FFT span is set to the marker frequency on display d. The span is decreased if necessary.

This command is only valid when the Measurement Group is FFT and display d is Live. This command is not valid if the Marker of display d is Off.

DREF d, i

The DREF command sets and clears the Display Reference for display d. If i is 0, the Display Reference is turned Off. If i is 1, the current data becomes the Display Reference and the Display Reference is turned On. DREF d,1 only sets the Display Reference if the Display Reference is currently off.

This is similar to the [Display Ref] key.

SNAP d

The SNAP command rescales the Reference Display of display d to the current display scale. (Same as [Snap Ref] key). This command has no effect if there is no Reference Display in display d.

SBRI (?) {i}

The SBRI command sets (queries) the Screen Brightness. The parameter i is a brightness level from 150 (dimmiest) to 255 (brightest).

SCON (?) {i}

The SCON command sets (queries) the Screen Contrast. The parameter i is a contrast level from 0 (no contrast) to 90 (most contrast).

KEYP i

The KEYP command performs the same function as pressing key *i* in the table below.

<u>key</u>	<u>i</u>
<Softkey 1> (top)	0
<Softkey 2>	12
<Softkey 3>	11
<Softkey 4>	10
<Softkey 5>	9
<Softkey 6>	8
<Softkey 7>	16
<Softkey 8>	24
<Softkey 9>	32
<Softkey 10> (bottom)	40
[Freq]	33
[Display Setup]	34
[Display Options]	35
[Marker]	36
[Source]	41
[Input]	42
[Trigger]	43
[Average]	44
[User Math]	49
[Window]	50
[Waterfall]	51
[Capture]	52
[Analysis]	57
[Disk]	58
[Output]	59
[System]	60
[AutoScale A]	37
[AutoScale B]	45
[Span Up]	53
[Span Down]	61
[AutoRange Ch1]	38
[AutoRange Ch2]	46
[Marker Max]	54
[Marker Min]	62
[Marker Ref]	39
[Display Ref]	47
[Marker Center]	55
[Show Setup]	63
[Start/Reset]	17
[Pause/Cont]	25
[Start Capture]	18
[Stop Capture]	26
[Active Display]	19
[Link]	27
[Print Screen]	20

5-88 Front Panel Commands

[Help/Local]	28
[Alt]	7
[Backspace]	6
[Exp]	5
[0]	29
[1]	21
[2]	22
[3]	23
[4]	13
[5]	14
[6]	15
[7]	2
[8]	3
[9]	4
[.]	30
[-]	31
[Enter]	1
[Brighter]	56
[Dimmer]	48

KNOB i

The KNOB command simulates turning the knob. The parameter *i* selects counter-clockwise (0) or clockwise (1).

TONE i, j

The TONE command makes an audible tone. The parameter *i* is the duration (in 5 ms increments) and *j* selects a note from 0 to 66.

Sequential TONE commands need to be separated by a pause which is at least as long as the preceding tone.

PLAY i

The PLAY command plays one of the SR780's pre-programmed sounds. The parameter *i* selects a sound from 0 to 6 (most recent TONE).

For example, PLAY 2 sounds an alert.

Data Transfer Commands

DSPN ? d

The DSPN ? command queries the length of display d. The parameter d selects Display A (0) or Display B (1).

The returned value is the length (number of points or bins) of display d. The points are numbered from 0 to (length-1).

Always use the DSPN ? command to determine the display length before reading all of the data from a display.

DSPY ? d {, j}

The DSPY ? command queries the data in display d. The parameter d selects Display A (0) or Display B (1).

The DSPY ? d, j command queries the data value of bin j only. The bins are numbered from 0 to length-1. The value is returned as an ASCII real number.

The DSPY ? d command queries all of the data in display d. Do not serial poll for IFC (bit 7) in the Serial Poll status after this command is sent. IFC will NOT be set until the transfer is complete. Send the command and then make the host computer a listener and the SR780 a talker. Data is returned continuously starting with bin 0 and ending with bin #(length-1). The data points are ASCII real numbers, separated by commas, and the last data point is followed by a terminator. If the DSPY? d command is used with the RS232 interface, the host computer interface must be fast enough to keep up with the data stream.

The DSPY ? command returns data from the last available display update. To keep the data static, pause the measurement or take the display Off-Line.

The returned data depends upon the display View and Units. The data values are the same as if they were read with the marker. In the case of a 2-D view (Nyquist or Nichols), two values per bin are returned (separated by a comma). The values are in the same order as shown in the Marker Position Bar. In this case, there are twice as many points returned.

To read the data in a Trace, recall the Trace to a display and then read the display.

DSPW ? d, i {, j}

The DSPW ? command queries the data in waterfall display d. The parameter d selects Display A (0) or Display B (1). This command is not valid if display d does not have waterfall storage on.

The DSPW ? d, i, j command queries the data value of bin j in record i only. The bins are numbered from 0 to length-1. The records are numbered from 0 to the current number of records stored minus 1. The value is returned as a real number.

5-90 Data Transfer Commands

The DSPW ? d, i command queries all of the data in record i. Do not serial poll for IFC (bit 7) in the Serial Poll status after this command is sent. IFC will NOT be set until the transfer is complete. Send the command and then make the host computer a listener and the SR780 a talker. Data is returned continuously starting with bin 0 and ending with bin #(length-1). The data points are ASCII real numbers, separated by commas, and the last data point is followed by a terminator. If the DSPW? d command is used with the RS232 interface, the host computer interface must be fast enough to keep up with the data stream.

The DSPW ? command returns data from the last available display update. To keep the data static, pause the measurement or take the display Off-Line.

The returned data depends upon the display View and Units. The data values are the same as if they were read with the marker.

REFY ? d, j

The REFY ? command queries the data in Reference Graph of display d. The parameter d selects Display A (0) or Display B (1). An error occurs if the display has no Reference Graph.

The REFY ? d, j command queries the Reference Graph data value of bin j only. The bins are numbered from 0 to length-1. The value is returned as an ASCII real number.

The returned data depends upon the display View and Units. The data values are the same as if they were read with a marker.

DSPB ? d {, j}

The DSPB? d command returns the data in display d in binary format. The parameter d selects Display A (0) or Display B (1). This command is only available with the GPIB interface.

The DSPB ? d, j command returns the data value of bin j only. The bins are numbered from 0 to length-1. The value is returned as a 4 byte IEEE float.

The DSPB ? d command returns all of the data in display d in binary format.

Do not serial poll for IFC (bit 7) in the Serial Poll status after DSPB ? is sent. IFC will NOT be set until the transfer is complete. Send the command and then make the host computer a listener and the SR780 a talker.

The DSPB? d returns 4 bytes per bin starting with bin 0 and continuing to bin #(length-1). There is no separation between data points. No line-feed follows the last data point, instead, EOI is asserted with the last byte. The 4 bytes are an IEEE floating point number.

The returned data depends upon the display View and Units. The data values are the same as if they were read with the marker. In the case of a 2-D view (Nyquist or Nichols), two values per bin are returned (8 bytes per bin). The first value is the Y axis value and the second is the X axis value. In this case, there are twice as many points returned.

The host interface must be capable of binary transfer, i.e. accepting line feeds and carriage returns as data rather than terminators. In addition, the host program must read exactly the correct number of bytes (4xlength or 8xlength). While a binary transfer is in progress, the analyzer will not respond to any other queries and the displays will not update.

If the host program does not start reading the points within 1 second, or pauses for 1 second while reading, the binary transfer will be aborted.

To read the data in a Trace, recall the Trace to a display and then read the display.

DSWB ? d, i {, j}

The DSWB? command returns the data in waterfall display d in binary format. This command is only available with the GPIB interface. The parameter d selects Display A (0) or Display B (1). This command is not valid if display d does not have waterfall storage on.

The DSWB ? d, i, j command returns the data value of bin j in record i only. The bins are numbered from 0 to length-1. The records are numbered from 0 to the current number of records stored. The value is returned as a 4 byte IEEE float.

The DSWB ? d, i command returns all of the data in record i in binary format.

Do not serial poll for IFC (bit 7) in the Serial Poll status after DSWB? is sent. IFC will NOT be set until the transfer is complete. Send the command and then make the host computer a listener and the SR780 a talker.

The DSWB? d, i returns 4 bytes per bin starting with bin 0 and continuing to bin #(length-1). There is no separation between data points. No line-feed follows the last data point, instead, EOI is asserted with the last byte. The 4 bytes are an IEEE floating point number.

The host interface must be capable of binary transfer, i.e. accepting line feeds and carriage returns as data rather than terminators. In addition, the host program must read exactly the correct number of bytes (4xlength). While a binary transfer is in progress, the analyzer will not respond to any other queries and the displays will not update.

If the host program does not start reading the points within 1 second, or pauses for 1 second while reading, the binary transfer will be aborted.

DBIN ? d, j

The DBIN? command queries the frequency or time of bin j in display d. The parameter d selects Display A (0) or Display B (1). The parameter j is bin from 0 to length-1.

The returned value is either a frequency (spectra), a time (time record or correlation) or a band center frequency (octave).

5-92 Data Transfer Commands

FBIN ? d, x

The FBIN ? command queries the bin number of x (frequency or time) in display d. The parameter d selects Display A (0) or Display B (1). The parameter x is a floating point value of Hz or seconds.

The returned value is an integer bin number.

TLOD ? i, n

The TLOD command loads binary data into Trace i. The parameter i selects Trace 1 through 5. This command is valid only via the GPIB interface.

The target Trace i must already store data of the measurement type and length to be loaded from the interface. The loaded data simply takes the place of the stored trace data and assumes the measurement parameters (Measurement, Averaging, Window, Frequency span, etc.) and length of Trace i.

TLOD loads the actual complex data values in the trace, NOT the data displayed in a particular view. Remember, views are simply different ways of showing the actual complex data.

A trace contains n complex points. The value of n depends upon the type and length of the target trace.

<u>Trace Type</u>	<u>n</u>
FFT, Coherence, CrossSpec, Transfer Function	
100 FFT lines	128 (1st 101 points displayed)
200 FFT lines	256 (1st 201 points displayed)
400 FFT lines	512 (1st 401 points displayed)
800 FFT lines	1024 (1st 801 points displayed)
Correlations	
Uniform window	2.56 times number of FFT lines (imaginary parts all zero)
T/2 window	1.28 times number of FFT lines (imaginary parts all zero)
Time Records	
Baseband Time	2.56 times number of FFT lines (all points are real, the imaginary parts should all be zero)
Non-baseband Time	1.28 times number of FFT lines (all points are complex)
Octave	number of displayed bins + 1 (the power bin is the last point) (all points are real, the imaginary parts should all be zero)
Swept Sine	Number of points in the sweep

Each complex point is two floating point numbers, representing the real and imaginary parts. Thus, the TLOD command loads 2n floating point numbers (4-byte IEEE floats).

The downloaded values are assumed to have the same units as the target trace. Depending upon the trace measurement, the values are assumed to be either unitless, Volts or Volts².

<u>Trace Measurement</u>	<u>Units</u>
FFT	V
Time	V
Coherence	unitless
Cross Spectrum	V ²
Transfer Function	unitless
Orbit	V
Correlation	V ²
UserFunction	unitless
Octave	V ²
Swept Sine	V

The download sequence is as follows:

Host

Send TLOD ? i, n. Do NOT wait for IFC to be set in the Serial Poll status.

SR780

Checks to make sure that Trace i has length n. Returns 1 (4-byte binary long int) if OK to begin data transfer. A return of 0 indicates that n is too large for Trace i.

Host

On receipt of 1 (4-byte binary long int), executes a binary transfer to the SR780 of 2n 4-byte IEEE floats. The order is real part of point 0, imag part of point 0, real part of point 1, imag part of point 1, etc. Each 4-byte float is transmitted least significant byte first. A total of 8n bytes are transferred. Assert EOI with the final byte of the transfer.

Serial Poll until IFC (bit 7) is set in the Serial Poll status before sending another command.

TASC ? i, n

The TASC command loads ASCII data into Trace i. The parameter i selects Trace 1 through 5. This command is valid only via the GPIB interface.

The target Trace i must already store data of the measurement type and length to be loaded from the interface. The loaded data simply takes the place of the stored trace data and assumes the measurement parameters (Measurement, Averaging, Window, Frequency span, etc.) and length of Trace i.

TASC loads the actual complex data values in the trace, NOT the data displayed in a particular view. Remember, views are simply different ways of showing the actual complex data.

A trace contains n complex points. The value of n depends upon the type and length of the target trace. See TLOD for more.

Each complex point is two floating point numbers, representing the real and imaginary parts. Thus, the TASC command loads $2n$ floating point numbers (in ASCII format).

The downloaded values are assumed to have the same units as the target trace. Depending upon the trace measurement, the values are assumed to be either unitless, Volts or Volts². See TLOD for more.

The download sequence is as follows:

Host

Send TASC ? i , n . Do NOT wait for IFC to be set in the Serial Poll status.

SR780

Checks to make sure that Trace i has length n . Returns 1 (4-byte binary long int) if OK to begin data transfer. A return of 0 indicates that n is too large for Trace i .

Host

On receipt of 1 (4-byte binary long int), executes a transfer to the SR780 of $2n$ ASCII floats. The order is real part of point 0, imag part of point 0, real part of point 1, imag part of point 1, etc. Each ASCII float is delimited by a comma, space, tab or carriage return (NOT EOI). Assert EOI with the final byte of the transfer.

Serial Poll until IFC (bit 7) is set in the Serial Poll status before sending another command.

ALOD ? n

The ALOD command loads binary data into the Arbitrary Waveform buffer. This command is valid only via the GPIB interface.

The parameter n specifies the number of points to be loaded and must be a multiple of 2048. The Arbitrary Waveform buffer must already have sufficient memory allocated. After the load is complete, the Arbitrary Length will be n points.

Each point is a 4-byte IEEE float number and range from -1.0 to +1.0. A value of 1.0 is output at 100% amplitude as 1 Volt. The data should not exceed this range.

The download sequence is as follows:

Host

Send ALOD ? n . Do NOT wait for IFC to be set in the Serial Poll status.

SR780

Checks to make sure that the Arbitrary buffer has sufficient length. Returns 1 (4-byte binary long int) if OK to begin data transfer. A return of 0 indicates that n is too large for the buffer.

Host

On receipt of 1 (4-byte binary long int), executes a binary transfer to the SR780 of n 4-byte IEEE floats. The order is point 0, point 1, etc. Each 4-byte float is transmitted least significant byte first. A total of 4n bytes are transferred. Assert EOI with the final byte of the transfer.

Serial Poll until IFC (bit 7) is set in the Serial Poll status before sending another command.

TGET ? i

The TGET command uploads a Trace buffer to the host computer. This command is valid only via the GPIB interface. The parameter i selects a Trace (1-5). Trace i must contain data.

The uploaded data should be saved in its entirety by the host computer. The saved data can be downloaded back to the SR780 at a later time using TPUT. The TGET and TPUT commands allow a host computer to save and reload a trace buffer without using disks.

TGET uploads trace information as well as trace data. TPUT restores the trace type, length and other attributes as well as the data.

The upload sequence is as follows:

Host

Send TGET ? i. Do NOT wait for IFC to be set in the Serial Poll status.

SR780

Returns n (4-byte binary long int) which is the number of bytes needed to transfer the Trace buffer.

Host

On receipt of n (4-byte binary long int), executes a binary read from the SR780 of n bytes. Expect EOI with the final byte of the transfer.

Serial Poll until IFC (bit 7) is set in the Serial Poll status before sending another command.

TPUT ? i

The TPUT command downloads Trace buffer data to the SR780. This command is valid only via the GPIB interface. The parameter i selects a Trace (1-5). Trace i does not need to already contain data.

The download data must be data which was originally uploaded by TGET in its entirety. The TGET and TPUT commands allow a host computer to save and reload a Trace buffer without using disks.

The download sequence is as follows:

Host

Send TPUT ? i. Do NOT wait for IFC to be set in the Serial Poll status.

SR780

Returns 1 (4-byte binary long int) when OK to begin binary transfer to the SR780.

Host

On receipt of 1 (4-byte binary long int), executes a binary transfer to the SR780 of n bytes (as uploaded using TGET). Asserts EOI with the final byte of the transfer.

SR780

Receives n bytes and the EOI. If an error is detected during transfer, the Trace buffer reverts to the empty state and a command execution error occurs.

Serial Poll until IFC (bit 7) is set in the Serial Poll status before sending another command.

AGET ? i

The AGET command uploads the Arbitrary Waveform buffer to the host computer. This command is valid only via the GPIB interface. The parameter i selects upload the whole buffer (0) or just the playback portion (1).

The uploaded data should be saved in its entirety by the host computer. The saved data can be downloaded back to the SR780 at a later time using APUT. The AGET and APUT commands allow a host computer to save and reload the Arbitrary buffer without using disks.

The upload sequence is as follows:

Host

Send AGET ? i. Do NOT wait for IFC to be set in the Serial Poll status.

SR780

Returns n (4-byte binary long int) which is the number of bytes needed to transfer the Arbitrary buffer.

Host

On receipt of n (4-byte binary long int), executes a binary read from the SR780 of n bytes. Expect EOI with the final byte of the transfer.

Serial Poll until IFC (bit 7) is set in the Serial Poll status before sending another command.

APUT ?

The APUT command downloads Arbitrary Waveform buffer data to the SR780. This command is valid only via the GPIB interface. After the download is complete, the Arbitrary Length will be set to the length of the download.

The download data must be data which was originally uploaded by AGET in its entirety. The AGET and APUT commands allow a host computer to save and reload the Arbitrary buffer without using disks.

The download sequence is as follows:

Host

Send APUT ?. Do NOT wait for IFC to be set in the Serial Poll status.

SR780

Returns 1 (4-byte binary long int) when OK to begin binary transfer to the SR780. A return of 0 indicates that there is no Arbitrary Waveform memory allocated.

Host

On receipt of 1 (4-byte binary long int), executes a binary transfer to the SR780 of n bytes (as uploaded using AGET). Asserts EOI with the final byte of the transfer.

SR780

Receives n bytes and the EOI. If an error is detected during transfer, the Arbitrary buffer reverts to the empty state and a command execution error occurs. This may occur if there is insufficient Arbitrary memory allocated.

Serial Poll until IFC (bit 7) is set in the Serial Poll status before sending another command.

CGET ? i, j

The CGET command uploads a Capture buffer to the host computer. This command is valid only via the GPIB interface. The parameter i selects Ch1 (0) or Ch2 (1). The parameter j selects upload the whole buffer (0) or just the playback portion (1).

The uploaded data should be saved in its entirety by the host computer. The saved data can be downloaded back to the SR780 at a later time using CPUT. The CGET and CPUT commands allow a host computer to save and reload the Capture buffer without using disks.

The upload sequence is as follows:

Host

Send CGET ? i, j. Do NOT wait for IFC to be set in the Serial Poll status.

SR780

Returns n (4-byte binary long int) which is the number of bytes needed to transfer the Capture buffer.

Host

On receipt of n (4-byte binary long int), executes a binary read from the SR780 of n bytes. Expect EOI with the final byte of the transfer.

Serial Poll until IFC (bit 7) is set in the Serial Poll status before sending another command.

CPUT ? i

The CPUT command downloads Capture buffer data to the SR780. This command is valid only via the GPIB interface. The parameter i selects Ch1 (0) or

Ch2 (1). After the download is complete, the Capture Length will be set to the length of the download.

The download data must be data which was originally uploaded by CGET in its entirety. The CGET and CPUT commands allow a host computer to save and reload the Capture buffer without using disks.

The download sequence is as follows:

Host

Send CPUT ? i. Do NOT wait for IFC to be set in the Serial Poll status.

SR780

Returns 1 (4-byte binary long int) when OK to begin binary transfer to the SR780. A return of 0 indicates that there is no Capture memory allocated.

Host

On receipt of 1 (4-byte binary long int), executes a binary transfer to the SR780 of n bytes (as uploaded using CGET). Asserts EOI with the final byte of the transfer.

SR780

Receives n bytes and the EOI. If an error is detected during transfer, the Capture buffer reverts to the empty state and a command execution error occurs. This may occur if there is insufficient Capture memory allocated.

Serial Poll until IFC (bit 7) is set in the Serial Poll status before sending another command.

WGET ?

The WGET command uploads the Waterfall buffer to the host computer. This command is valid only via the GPIB interface.

The uploaded data should be saved in its entirety by the host computer. The saved data can be downloaded back to the SR780 at a later time using WPUT. The WGET and WPUT commands allow a host computer to save and reload the Waterfall buffer without using disks.

The upload sequence is as follows:

Host

Send WGET ?. Do NOT wait for IFC to be set in the Serial Poll status.

SR780

Returns n (4-byte binary long int) which is the number of bytes needed to transfer the Waterfall buffer.

Host

On receipt of n (4-byte binary long int), executes a binary read from the SR780 of n bytes. Expect EOI with the final byte of the transfer.

Serial Poll until IFC (bit 7) is set in the Serial Poll status before sending another command.

WPUT ?

The WPUT command downloads Waterfall buffer data to the SR780. This command is valid only via the GPIB interface.

The download data must be data which was originally uploaded by WGET in its entirety. The WGET and WPUT commands allow a host computer to save and reload the Waterfall buffer without using disks.

The download sequence is as follows:

Host

Send WPUT ?. Do NOT wait for IFC to be set in the Serial Poll status.

SR780

Returns 1 (4-byte binary long int) when OK to begin binary transfer to the SR780. A return of 0 indicates that there is no Waterfall memory allocated.

Host

On receipt of 1 (4-byte binary long int), executes a binary transfer to the SR780 of n bytes (as uploaded using WGET). Asserts EOI with the final byte of the transfer.

SR780

Receives n bytes and the EOI. If an error is detected during transfer, the Waterfall buffer reverts to the empty state and a command execution error occurs. This may occur if there is insufficient Waterfall memory allocated.

Serial Poll until IFC (bit 7) is set in the Serial Poll status before sending another command.

Loading the Waterfall buffer loads data into the waterfall buffer *and* recalls the measurement parameters which were in effect when the waterfall buffer was saved. The recalled parameters include items in the [Frequency], [Display Setup], [Display Options], [Average], [Window], [User Math], and [Waterfall] menus.

The Waterfall Storage is set to Recalled. Recalled simply means that the waterfall displays contain data which did not come from the two inputs but rather from disk.

Recalled waterfall data is *not* protected in any way! The recalled waterfall data behaves as if the measurement was paused. Pressing [Start/Reset] or changing any measurement parameter which normally causes the waterfall buffer to reset and take new data will *destroy the recalled data!* The recalled data is available for viewing and hardcopy only.

Interface Commands

***RST**

The *RST command resets the SR780 to its default configurations. The communications setup is not changed. All other modes and settings are set to their default conditions and values. This command takes some time to complete.

Do not send other commands on the same command line after *RST. Do not send another command until *RST is complete. Either wait a fixed amount of time (approximately 12 seconds) or use serial polling to wait for IFC to be set again in the Serial Poll status before sending more commands.

***IDN ?**

The *IDN ? query returns the SR780's device identification string. This string is in the format "Stanford_Research_Systems,SR780, s/n00001, ver007". In this example, the serial number is 00001 and the firmware version is 007.

LOCL (?) {i}

The LOCL command sets the local/remote state. The parameter *i* selects LOCAL (0), REMOTE (1) or LOCAL LOCKOUT (2). The states duplicate the GPIB local/remote states. In the LOCAL state, both command execution and keyboard input are allowed. In the REMOTE state command execution is allowed but the keyboard and knob are locked out except for the [Help/Local] key which returns the SR780 to the LOCAL state. In the LOCAL LOCKOUT state all front panel operation is locked out, including the [Help/Local] key.

OVRM (?) {i}

The OVRM command sets (queries) the GPIB Override Remote mode. The parameter *i* selects No (0) or Yes (1). When Override Remote is set to Yes, the front panel is not locked out when the unit is in the REMOTE state.

Nodal Degree-of-Freedom Commands

SVNI (?) {i}

The SVNI command determines (queries) whether nodal degree-of-freedom information will be stored with SR785 data (.78D) files. If this softkey is set to “on” nodal DOF information will be saved with the files and will be available for use by external programs which convert SR785 files into formats used by modal analysis programs. If set to “off” no nodal DOF information will be saved and the external programs must obtain this information from the user.

RFDR (?) {i}

The RFDR command sets (queries) the reference node direction. The parameter *i* specifies the direction according to the following table:

<i>i</i>	<u>Node Direction</u>
0	-θ Z
1	-θ Y
2	-θ X
3	-Z
4	-Y
5	-X
6	Scalar (no direction)
7	X
8	Y
9	Z
10	+θ X
11	+θ Y
12	+θ Z

RFNA (?) {s}

The RFNA command sets (queries) the name of the reference node. The name may be up to 6 characters long.

RFNU (?) {i}

The RFNU command sets (queries) the number of the reference node.

RSDR (?) {i}

The RSDR command sets (queries) the response node direction. The parameter *i* specifies the direction according to the following table:

5-102 Nodal DOF Commands

<u>i</u>	<u>Node Direction</u>
0	-θ Z
1	-θ Y
2	-θ X
3	-Z
4	-Y
5	-X
6	Scalar (no direction)
7	X
8	Y
9	Z
10	+θ X
11	+θ Y
12	+θ Z

RSNA (?) {s}

The RSNA command sets (queries) the name of the reference node. The name may be up to 6 characters long.

RSNU (?) {i}

The RSNU command sets (queries) the name of the reference node.

Status Reporting Commands

The Status Word definitions follow this section.

***CLS**

The *CLS command clears all status registers. The enable registers are not changed.

***PSC (?) {i}**

The *PSC command sets the value of the power-on status clear bit.

If i=1 the power-on status clear bit is set and all status registers and enable registers are cleared on power up.

If i=0 the bit is cleared and all enable registers are stored at power down. The status registers are cleared and the enable registers are restored to their stored values on power up. This allows a service request to be generated at power up.

***SRE (?) {i} {, j}**

The *SRE i command sets the Serial Poll enable register to the decimal value i (0-255). The *SRE i, j command sets bit i (0-7) to j (0 or 1).

The *SRE? command queries the value (0-255) of the serial poll enable register. The *SRE? i command queries the value (0 or 1) of bit i (0-7).

When a bit becomes set in BOTH the Serial Poll status word AND the Serial Poll enable register, an SRQ (GPIB service request) is generated. The SRQ is cleared by performing a serial poll. The bit in the Serial Poll status word which caused the SRQ must be cleared before this bit can cause another SRQ. To clear this bit, the condition which causes it to be set in the Serial Poll status word needs to be cleared. For the INST, DISP, INPT, IERR or ESB bits, this is accomplished by clearing the enabled status bits in the Instrument, Display, Input, Error or Standard Event status words (by reading them).

***STB ? {i}**

The *STB? command queries the value of the Serial Poll status word. The value is returned as a decimal number from 0 to 255. The *STB? i command queries the value (0 or 1) of bit i (0-7).

The value of bit 6 (SRQ) when read using *STB? returns 1 if a bit is set in BOTH the Serial Poll status word AND the Serial Poll enable register. This is independent of serial polling and SRQ's. Bit 6 is the SRQ bit only when serial polled.

*STB? has no effect on the value of the Serial Poll status word. To clear a bit in the Serial Poll status, the condition which causes it to be set must be cleared. For the INST, DISP, INPT, IERR or ESB bits, this is accomplished by clearing the enabled status bits in the Instrument, Display, Input, Error or Standard Event status words (by reading them).

5-104 Status Reporting Commands

***ESE (?) {i} {, j}**

The *ESE i command sets the Standard Event enable register to the decimal value i (0-255). The *ESE i, j command sets bit i (0-7) to j (0 or 1).

The *ESE? command queries the value (0-255) of the status word enable register. The *ESE? i command queries the value (0 or 1) of bit i (0-7).

When a bit becomes set in BOTH the Standard Event status word AND the Standard Event enable register, bit 6 (ESB) of the Serial Poll status word is set. This causes an SRQ if bit 6 in the Serial Poll enable register is set. To clear a bit in the Standard Event status word, use *ESR?.

***ESR ? {i}**

The *ESR? command queries the value of the Standard Event status word. The value is returned as a decimal number from 0 to 255. The *ESR? i command queries the value (0 or 1) of bit i (0-7).

*ESR? clears the entire word while *ESR? i clears just bit i.

ERRE (?) {i} {, j}

The ERRE i command sets the Error enable register to the decimal value i (0-65535). The ERRE i, j command sets bit i (0-15) to j (0 or 1).

The ERRE? command queries the value (0-65535) of the error status enable register. The ERRE? i command queries the value (0 or 1) of bit i (0-15).

When a bit becomes set in BOTH the Error status word AND the Error status enable register, bit 3 (IERR) of the Serial Poll status word is set. This causes an SRQ if bit 3 in the Serial Poll enable register is set. To clear a bit in the Error status word, use ERRS?.

ERRS ? {i}

The ERRS? command queries the value of the Error status word. The value is returned as a decimal number from 0 to 65535. The ERRS? i command queries the value (0 or 1) of bit i (0-15).

ERRS? clears the entire word while ERRS? i clears just bit i.

INSE (?) {i} {, j}

The INSE i command sets the Instrument status enable register to the decimal value i (0-255). The INSE i, j command sets bit i (0-7) to j (0 or 1).

The INSE? command queries the value of the Instrument status enable register. The INSE? i command queries the value (0 or 1) of bit i (0-7).

When a bit becomes set in BOTH the Instrument status word AND the Instrument status enable register, bit 0 (INST) of the Serial Poll status word is set. This causes an SRQ if bit 0 in the Serial Poll enable register is set. To clear a bit in the Instrument status word, use INST?.

INST ? {i}

The INST? command queries the value of the Instrument status word. The value is returned as a decimal number from 0 to 255. The INST? i command queries the value (0 or 1) of bit i (0-7).

INST? clears the entire word while INST? i clears just bit i.

DSPE (?) {i} {, j}

The DSPE i command sets the Display status enable register to the decimal value i (0-65535). The DSPE i, j command sets bit i (0-15) to j (0 or 1).

The DSPE? command queries the value of the Display status enable register. The DSPE? i command queries the value (0 or 1) of bit i (0-15).

When a bit becomes set in BOTH the Display status word AND the Display status enable register, bit 1 (DISP) of the Serial Poll status word is set. This causes an SRQ if bit 1 in the Serial Poll enable register is set. To clear a bit in the Display status word, use DSPE?.

DSPE ? {i}

The DSPE? command queries the value of the Display status word. The value is returned as a decimal number from 0 to 65535. The DSPE? i command queries the value (0 or 1) of bit i (0-15).

DSPE? clears the entire word while DSPE? i clears just bit i.

INPE (?) {i} {, j}

The INPE i command sets the Input status enable register to the decimal value i (0-65535). The INPE i, j command sets bit i (0-15) to j (0 or 1).

The INPE? command queries the value of the Input status enable register. The INPE? i command queries the value (0 or 1) of bit i (0-15).

When a bit becomes set in BOTH the Input status word AND the Input status enable register, bit 2 (INPT) of the Serial Poll status word is set. This causes an SRQ if bit 2 in the Serial Poll enable register is set. To clear a bit in the Input status word, use INPE?.

INPS ? {i}

The INPS? command queries the value of the Input status word. The value is returned as a decimal number from 0 to 65535. The INPS? i command queries the value (0 or 1) of bit i (0-15).

INPS? clears the entire word while INPS? i clears just bit i.

INPC ? i

The INPC? command queries the current overload condition of input i. The parameter i selects Ch1 (0) or Ch2 (1).

INPC? returns a value from 0 to 3.

5-106 Status Reporting Commands

<u>return</u>	<u>meaning</u>
0	input is under half scale
1	input is over half scale
2	input is overloaded
3	input is HighV

INPC? always returns the current condition. If an overload occurs and goes away, INPC? will not detect it. Use the status words to detect momentary changes in the overload state.

Status Word Definitions

The SR780 reports on its status by means of six status words: the Serial Poll, Standard Event, Instrument, Display, Input and Error status words.

Upon power-on, the SR780 may either clear all of its status *enable* registers or maintain them in the state they were in on power-down. The *PSC command determines which action will be taken.

The status bits are set to 1 when the event or state described in the tables below has occurred or is present.

Serial Poll Status Word

Bit	Name	Set when
0	INST	An enabled bit in the Instrument status word is set
1	DISP	An enabled bit in the Display status word is set
2	INPT	An enabled bit in the Input status word is set
3	IERR	An enabled bit in the Error status word is set
4	MAV	The interface output buffer is not empty
5	ESB	An enabled bit in the Standard status word is set
6	SRQ	An SRQ has occurred (serial poll), or an enabled bit in the this status word is set (*STB?)
7	IFC	No command execution is in progress

The INST, DISP, INPT, IERR and ESB bits are set whenever any bit in both their respective status words AND enable registers is set. Use the INSE, DSPE, INPE, ERRE and *ESE commands to set the enable register bits. The INST, DISP, INPT, IERR and ESB status bits are not cleared until ALL enabled status bits in the Instrument, Display, Input, Error and Standard Event status words are cleared (by reading the status words or using *CLS).

Use serial poll or *STB? to read the Serial Poll status. Use *SRE to set bits in the Serial Poll enable register.

Using *STB? to Read the Serial Poll Status

The Serial Poll status word is NOT cleared by reading the status using *STB?. A bit stays set as long as the status condition exists. This is true even for bit 6 (SRQ). Bit 6 will be set whenever the same bit in the Serial Poll status word AND Serial Poll enable register is set. This is independent of whether a serial poll has occurred to clear the service request.

Using Serial Poll to Read the Serial Poll Status

Except for SRQ, a bit in the Serial Poll status word is NOT cleared by serial polling the status word. A bit stays set as long as the status condition exists.

When reading the status using a serial poll, the SRQ bit signals that the SR780 is requesting service. The SRQ bit will be set (1) the first time the SR780 is polled following a service request. The serial poll automatically clears the service

request. Subsequent serial polls will return SRQ cleared (0) until another service request occurs. Polling the status word and reading it with *STB? can return different values for SRQ. When serial polled, SRQ indicates a service request has occurred. When read with *STB?, SRQ indicates that an enabled status bit is set.

Service Requests (SRQ)

A GPIB service request (SRQ) will be generated whenever a bit in both the Serial Poll status word AND Serial Poll enable register is set. Use *SRE to set bits in the Serial Poll enable register. A service request is only generated when an enabled Serial Poll status bit becomes set (changes from 0 to 1). An enabled status bit which becomes set and remains set will generate a single SRQ. If another service request from the same status bit is desired, the requesting status bit must first be cleared. In the case of the INST, DISP, INPT, IERR and ESB bits, this means clearing the enabled bits in the Instrument, Display, Input, Error or Standard Event status words (by reading them) or clearing the appropriate bits in the corresponding enable registers. Multiple enabled bits in these status words will generate a single SRQ. Another SRQ (from INST, DISP, INPT, IERR or ESB) can only be generated after clearing the INST, DISP, INPT, IERR or ESB bits in the Serial Poll status word.

The controller should respond to the SRQ by performing a serial poll to read the Serial Poll status word to determine the requesting status bit. Bit 6 (SRQ) will be reset by the serial poll.

For example, to generate a service request when a TRIGGER occurs, bit 0 in the Instrument Status enable register needs to be set (INSE 1 command) and bit 0 in the Serial Poll enable register must be set (*SRE 1 command). When a trigger occurs, bit 0 in the Instrument status word is set. Since bit 0 in the Instrument status word AND enable register are set, this ALSO sets bit 0 (INST) in the Serial Poll status word. Since bit 0 in the Serial Poll status word AND enable register are set, an SRQ is generated. Bit 6 (SRQ) in the Serial Poll status word is set. Further triggering will not generate another SRQ until the TRIGGER status bit is cleared. The TRIGGER status bit is cleared by reading the Instrument status word (with INST?) or clearing bit 0 in the Instrument status enable register (with INSE). Presumably, the controller is alerted to the trigger via the SRQ, performs a serial poll to clear the SRQ, does something in response to the trigger (read data for example) and then clears the TRIGGER status bit by reading the Instrument status register. A subsequent trigger will then generate another SRQ.

Standard Event Status Word

<u>Bit</u>	<u>Name</u>	<u>Set when</u>
0	unused	
1	unused	
2	QRY	Too many responses are pending
3	DDE	Too many commands received at once
4	EXE	Command cannot execute successfully
5	CME	Command syntax error
6	URQ	A key is pressed or the knob rotated
7	PON	Power is turned on

8-15 unused reserved by IEEE standard

The Standard Event status word is defined by IEEE-488.2 (1987) and is used primarily to report errors in commands received over the interface. These status bits remain set until read using *ESR?. They are also cleared by the *CLS command. Use *ESE to set bits in the Standard Event enable register.

Instrument Status Word

<u>Bit</u>	<u>Name</u>	<u>Set when</u>
0	TRIG	A measurement has been triggered
1	DISK	A disk operation has been completed
2	OUTP	A hardcopy output operation has completed
3	unused	
4	CAPT	The capture buffer has filled
5	PAUS	Measurement has been paused
6	STRT	Measurement has been started
7	PLBK	Single Shot Capture Playback has finished
8	PREV	Measurement stopped to wait for average preview
9-15	unused	

The Instrument status word reports on the overall measurement status of the instrument. These status bits remain set until read by INST?. They are also cleared by the *CLS command. Use INSE to set bits in the Instrument status enable register.

Display Status Word

<u>Bit</u>	<u>Name</u>	<u>Set when</u>
0	NEWA	New data is available for DisplayA
1	AVGA	DisplayA linear average has completed
2	STLA	New settled data is available for DisplayA
3	LIMA	DisplayA has failed a limit test
4	SSA	Swept Sine sweep has finished
5	WFA	Display A 1-shot Waterfall has finished
6-7	unused	
8	NEWB	New data is available for DisplayB
9	AVGB	DisplayB linear average has completed
10	STLB	New settled data is available for DisplayB
11	LIMB	DisplayB has failed a limit test
12	SSB	Swept Sine sweep has finished
13	WFB	Display B 1-shot Waterfall has finished
14-15	unused	

The Display status bits stay set until read by DSPS?. They are also cleared by the *CLS command. Use DSPE to set bits in the Display status enable register.

5-110 Status Word Definitions

The AVG, STL, LIM and SS bits are only updated when new data is available for the display (no faster than 8 Hz). Always test for NEWA or NEWB in the status word along with AVG, STL, LIM or SS.

The status updates for the two displays may not be exactly synchronous. Always test the DisplayA status bits separately from the DisplayB status bits. For example, to wait for both displays to finish averaging, do NOT test the Display status word for both AVGA and AVGB simultaneously. The AVGA and AVGB bits may not be set at the same time. Test for AVGA and AVGB separately and wait until both have occurred.

Input Status Word

<u>Bit</u>	<u>Name</u>	<u>Set when</u>
0	LOW1	Input1 has fallen below half full scale
1	HLF1	Input1 has exceeded half full scale
2	OVL1	Input1 has exceeded full scale
3	HIV1	Input1 has exceeded 35 dBV
4	ARG1	Input range switched to 34 dBV. Input1 has AutoRanged
5-7	unused	
8	LOW2	Input2 has fallen below half full scale
9	HLF2	Input2 has exceeded half full scale
10	OVL2	Input2 has exceeded full scale
11	HIV2	Input2 has exceeded 35 dBV.
12	ARG2	Input range switched to 34 dBV. Input2 has AutoRanged
13-15	unused	

These status bits do not necessarily reflect the current input status. The Input status bits stay set until read by INPS?. They are also cleared by the *CLS command. Use INPE to set bits in the Input status enable register.

To read the current input overload condition, use INPC?.

Error Status Word

<u>Bit</u>	<u>Name</u>	<u>Set when</u>
0	OUTE	An output error has occurred (Print, Plot or Dump)
1	DSKE	A disk error has occurred
2	FLTE	A math error has occurred
3	RAME	RAM memory test fails
4	ROME	ROM memory test fails
5	VIDE	Video memory test fails
6	HELPE	Help memory test fails
7	DSDE	DSP data memory test fails
8	DSPE	DSP program memory test fails
9	DSRE	DSP DRAM memory test fails

10	CAL0	DSP calibration memory fails
11	CAL1	Ch1 calibration memory fails
12	CAL2	Ch2 calibration memory fails
13-15	unused	

The Error status bits stay set until read by ERRS?. They are also cleared by the *CLS command. Use ERRE to set bits in the Error status enable register.

Bits 7-12 are set by the power on tests. Bits 3-5 are set in the [System]<Diagnostics>.

Example Program

Using Microsoft C with the GPIB interface

To successfully interface the SR780 to a PC via the GPIB interface, the instrument, interface card and interface drivers must all be configured properly. To configure the SR780, the GPIB address must be set in the [System]<Remote> menu. The default address is 10; use this address unless a conflict occurs with other instruments in your system. The SR780 will be set to GPIB address 10 whenever a reset is performed (power on with the backspace key down).

Make sure that you follow all of the instructions for installing the GPIB card. The GPIB card cannot be simply unpacked and put into your computer. To configure the card, you may need to set jumpers and switches on the card to set the I/O address and interrupt levels. Refer to your manual for more information.

Capital Equipment Corp. CEC488 GPIB Card

The CEC488 card contains its low level drivers in ROM. The card address needs to be set so as not to conflict with other devices in your computer. The software interface uses a header file and a link library. There is no initialization required for the drivers.

Use the TEST488 program to test the card installation. Use TRTEST to communicate directly from the keyboard with the SR780. If TRTEST doesn't work, then your programs will not run.

The example is written using the CEC library routines.

National Instruments GPIB Card

You must run the program "IBCONF" to configure the resident GPIB driver for your GPIB card. Please refer to the National Instruments manual for more information. For example, the following options should be set with IBCONF:

Device Name:	sr780
Device Address:	10
EOS Character:	0Ah (linefeed)
Terminate Read on EOS:	Yes

Once all the hardware and GPIB drivers are configured, use "IBIC". Use "IBWRT" and "IBRD" to send to and receive from the SR780. If you cannot talk to the SR780 via "IBIC", then your programs will not run.

To modify the example to use a National Instruments card, modify the routines where indicated.

Other GPIB cards

You need to setup and configure your card according to your manual. The example program points out the routines which are interface dependent. Your card should have functions equivalent to those used in the example.

5-114 Example Program

```
// *****
// Example program using Microsoft C v7.0 and
// the Capital Equipment Corp CEC488 GPIB interface card.
// To use another interface card, modify the GPIB subroutines
// where indicated.

// The SR780 is assumed to be at address 10 (default).

// Link this object file with ieee488.lib (or the library for your GPIB card).

// *****
// Connect the Source output to the Ch1 A and Ch2 A inputs!!
// *****

#include <stdio.h>
#include <stdlib.h>
#include <string.h>
#include <conio.h>
#include <math.h>
#include <ieee-c.h> //This is the CEC header file
                   //Use the .h file for your interface card.
                   //send(), enter(), transmit(), rarray(), tarray() are
                   //CEC routines defined in ieee-c.h

char recv[80];      //global GPIB receive string
char cmd[80];      //global GPIB command string
float rxBuff[401]; //array of IEEE floats to receive binary data
float txBuff[2048]; //array of IEEE floats to send binary data
int status, length; //CEC interface routines use these variables

#define sr780 10    // default GPIB address for SR780

// subroutines at the end of this listing
// you may need to modify these for your interface card!
void TxGpib (int, char *);
void GetGpib (int);
void TxSr780 (char *);
void GetSr780 (char *);
void WaitAvg (void);
double GetData (int, int);
void WaitIFC (void);
void GetSpace (void);

void main (void);

/* ***** */
void main (void)
{
    // *****
    // You can see the commands received and responses generated by the SR780
    // by using [System]<Remote><View Qs> to display the interface buffers
    // on the screen.
    // *****

    int i, mode, type, number, nlen;
    long ack;
    double dispAVal, dispBVal, octreal, octimag;

    printf ("\nSR780 Example Program\n\n");
}
```



```

// ***** initialize your GPIB card here *****
initialize (21,0); //controller
settimeout (7500); //GPIB timeout to 7.5 seconds

// ***** Set the SR780 output interface to GPIB!! *****
TxSr780 ("*CLS"); //clear all status words
TxSr780 ("OUTX0"); //direct SR780 responses to GPIB interface

// ***** set the Standard Event enable register to catch EXE and CME
// Command errors will set the ESB bit in the Serial Poll status word
TxSr780 ("*ESE 48"); //set bits 4 and 5

// ***** Check communication by querying SR780 IDN string
GetSr780 ("*IDN?");
printf ("[GPIB IDN] = %s\n\n", recv);

printf ("Reset SR780...");
TxSr780 ("*RST"); // reset the SR780 to a default state
printf ("done\n\n");

/* ***** set up FFT averaging for both displays ***** */
TxSr780 ("FAVM 2,1"); //mode = rms
TxSr780 ("FAVT 2,0"); //type = linear
TxSr780 ("FAVN 2,250"); //number = 250
TxSr780 ("FAVG 2,1"); //avg = On

// ***** query these parameters for DisplayA *****
GetSr780 ("FAVM? 0"); mode = atoi(recv);
GetSr780 ("FAVT? 0"); type = atoi(recv);
GetSr780 ("FAVN? 0"); number = atoi(recv);
printf ("Avg mode = %d : type = %d : number = %d\n\n",mode,type,number);

printf ("Avg start...");
WaitAvg (); //start a linear average and wait until done
printf ("done\n");

TxSr780 ("ASCL 0; ASCL 1"); //autoscale the displays

/* ***** read data points ***** */
dispAVal = GetData (0,40); //read DisplayA bin 40 (peak)
dispBVal = GetData (1,40); //read DisplayB bin 40
printf ("DisplayA = %lf dBVpk\n",dispAVal);
printf ("DisplayB = %lf dBVpk\n",dispBVal);

/* ***** Binary transfer all of DisplayA spectrum ***** */
//We need to send the DSPB?0 command WITHOUT waiting for
//IFC in serial poll status since IFC will not be set until
//AFTER the transfer is complete!
//This section needs to be modified for your GPIB interface

printf ("\nReading entire DisplayA...");
TxGpib (sr780,"DSPB? 0"); //use TxGpib (don't wait for IFC)
transmit ("MLA TALK 10", &status); //make the PC listen, SR780 talk
rarray (rxBuff, 1604, &length, &status); //binary read 1604 bytes
//401 points x 4 bytes/point
WaitIFC (); //serial poll until IFC set, ok to continue

printf ("%d bytes read\n",length); //actual number of bytes read

```

5-116 Example Program

```
// ***** print a few points from the spectrum
for (i=37; i<44; i++) {printf ("bin %d = %f dBVpk\n", i, rxBuff[i]);}
printf ("\n");

/* *****
/* ***** Turn on limit testing ***** */
TxSr780 ("LCLR 0"); //first clear any existing limits for DisplayA
TxSr780 ("LMAX 0,2"); //initialize 2 segments
TxSr780 ("LSEG 0,0,0,12.032E3,-90.0,102.4E3,-90.0"); //upper segment
TxSr780 ("LSEG 0,1,0,1.28E3,-90.0,8.96E3,-90.0"); //upper segment
TxSr780 ("LTST 0,1"); //turn on testing

// ***** take a new measurement
printf ("Avg start...");
WaitAvg ();
printf ("done\n");

GetSr780 ("LFAL?0"); //read limit test result
printf ("Limit test = ");
if (atoi(recv)==0) printf ("pass"); else printf ("fail");
printf ("\n\n");

// ***** clean up
TxSr780 ("LCLR 0"); //clear limits, turn off testing
TxSr780 ("FAVG 2,0"); //turn avg off

/* *****
/* ***** Load the arbitrary waveform buffer ***** */
// construct a normalized ramp of 2048 points
// each point is a 4 byte IEEE float between -1.0 and +1.0
for (i=0; i<2048; i++) { txBuff[i] = ((float) i)/2048.F; }

//This section needs to be modified for your GPIB interface

printf ("Loading Arb buffer...");
TxGpib (sr780,"ALOD? 2048"); //use TxGpib so we don't wait for IFC
//SR780 will return a binary 1 to acknowledge
transmit("mla talk 10",&status); //make SR780 a talker, pc a listener
rarray (&ack, 4, &length, &status); //binary read 4 bytes (long int)
//return value should be 1
printf ("%d bytes recvd [val=%ld]...",length,ack);

transmit("mta listen 10",&status); //make SR780 a listener, pc a talker
tarray (txBuff,8192,1,&status); //binary transfer of 8192 bytes to SR780
// (2048 points x 4 bytes/point)
//set EOI with last byte
WaitIFC (); //serial poll until IFC set, ok to continue
printf ("done\n");

TxSr780 ("STYP 3"); //change source type to Arb
TxSr780 ("I1RG 4; I2RG 4"); //increase the input ranges
TxSr780 ("FSPN 2,3.2E3"); //narrow the span to display the spectrum
GetSpace (); //pause to look

/* *****
/* ***** Switch to Octave Analysis ***** */
TxSr780 ("STYP 2"); //switch to Noise source
TxSr780 ("NTYP 2"); //choose Pink noise
TxSr780 ("MGRP 2,1"); //switch to Octave measurement group
```

```

printf ("\n\nWait for octave settle...");
GetSr780 ("DSPS?"); //clear any sticky bits in the Display status word
//and then wait until the settle bits become set
do { GetSr780 ("DSPS?"); } while ( (atoi(recv)&0x0404) != 0x0404 );
printf ("done\n\n");

TxSr780 ("SVTR 0,5"); //save DisplayA to Trace5
TxSr780 ("RCTR 1,5"); //recall Trace5 to DisplayB
GetSr780 ("DSPN? 1"); nlen = atoi(recv); //query the length of DisplayB
printf ("DisplayB length = %d\n",nlen);

/* ***** */
/* ***** Download an octave trace ***** */
// Make Trace5 a constant -27 dBVpk for all bins.
// Convert -27 dBVpk to Volts (10^(-27/20))=0.04467
// Trace5 is already defined as an Octave measurement
// so the downloaded points are assumed to be Volts squared!
octreal = 0.04467*0.04467; //((44.67 mV)^2 real part
octimag = 0.0; //no imaginary part

//This section needs to be modified for your GPIB interface

printf ("Loading Trace 5...");
TxGpib (sr780,"TASC? 5,34"); //use TxGpib (no wait for IFC RDY)
//TASC downloads ASCII data,
//use TLOD to download binary data.
transmit("mla talk 10",&status); //make SR780 a talker, pc a listener
rarray (&ack, 4, &length, &status); //binary read 4 bytes (long int)
//return value should be 1
printf ("%d bytes recvd [val=%ld]...",length,ack);

// TASC (TLOD) replaces the data in an existing Trace (5).
// The Trace measurement and length are not changed!
// Download 34 bins of data (real, imaginary) with commas to separate,
// and EOI at the end.
// First 33 bins are the spectrum, last bin is the Total Power bin.
// All points are complex.
// For an octave measurement, the imaginary parts are all zero.
transmit("mta listen 10",&status); //make SR780 a listener, pc a talker
for (i=0; i<33; i++) { //download 33 octave bins
    sprintf (cmd,"DATA '%lf, '", octreal); //real part
    transmit (cmd,&status);
    sprintf (cmd,"DATA '%lf, '", octimag); //imaginary part
    transmit (cmd,&status);
}
// last bin is the total power bin
sprintf (cmd,"DATA '%lf, '", octreal*33); //real part of total power bin
transmit (cmd,&status);
sprintf (cmd,"DATA '%lf' END", 0.0); //imag part of total power bin,
transmit (cmd,&status); //last value, terminate with EOI!
WaitIFC (); //serial poll until IFC set, ok to continue

printf ("done\n");

TxSr780 ("RCTR 1,5"); //recall Trace 5 to DisplayB to view the new data

/* ***** */
/* ***** Define a User Function ***** */
// define Func1 = Oct(1)/Trace5
TxSr780 ("USRO 1,14,-5,45"); //14=Oct(1), -5=divide, 45=Trace5
TxSr780 ("MEAS 0,25"); //DisplayA measures UserFunc1

```

5-118 Example Program

```
TxSr780 ("YMAX 0,40");           //Change the top graph scale.
                                //Func1 is Oct(1) normalized by Trace5.
                                //The amplitudes are approximately 0 dB.
                                //The Total Power bin is calculated from the
                                //sum of the octave bins in the function,
                                //(it is not normalized to Trace5).

// ***** end of main program
}

/* ***** */
void TxGpib (int address,char *command)
// routine to transmit command to a GPIB address
// modify this routine for your GPIB interface

{
send (address,command,&status); // send() is the CEC routine to send
                                // a string to an address.
                                // Sets status = 0 to indicate result OK

if (status != 0) {
// handle transmit errors here
printf ("\nCommand = %s\n",command);
printf ("Error at device %d : status = %d\n",address,status);
GetSpace ();
}
}

/* ***** */
void GetGpib (int address)
// routine to get an answer from a GPIB address
// modify this routine for your GPIB interface

{
char temp[80];

enter (temp,80,&length,address,&status); // enter () is the CEC routine
// to enter a string from an address.
// Sets status = 0 to indicate result OK.
// 80 is maxlen, actual received length
// is stored in &length.

if (status != 0) {
// handle receive errors here
printf ("\nError at device %d : status = %d\n",address,status);
GetSpace ();
}

strcpy (recv, temp); //set global recv string
}

/* ***** */
void TxSr780 (char *command)
// Send command to the SR780 and wait until IFC (bit7) is set in
// the Serial Poll status (indicating that the command is finished).

{
TxGpib (sr780,command); // send command to sr780 address
WaitIFC ();             //serial poll until IFC set, ok to continue
}

/* ***** */
void WaitIFC (void)
{
//serial poll until IFC (bit7) set (command done)
//modify for your GPIB interface
```

```

//stb is serial poll byte
char stb;

do {spoll(sr780,&stb,&status);} while (!(stb&128)); //IFC

if (stb&32) {
    // If ESB bit set,
    // there must be a command error in the Standard Event status word.
    // Handle command errors here.
    TxGpib (sr780, "*ESR?"); //clear the Standard Event status word
    GetGpib (sr780);
    printf ("\nEXE error\n");
    GetSpace ();
}
}
/* ***** */
void GetSr780 (char *getcmd)
// query the sr780 for an answer
// getcmd is the query command string

{
    TxSr780 (getcmd); //send query command
    GetGpib (sr780); //get response into global recv string
}
/* ***** */
void WaitAvg (void)
{
    // routine to start a linear avg and wait until both displays are done

    int result, avgdone;

    avgdone=0; //init avgdone status
    GetSr780 ("DSPS?"); //clear sticky bits in Display status word first

    TxSr780 ("STRT"); //start lin average measurement

    do {
        GetSr780 ("DSPS?"); result=atoi(recv); //read display status word
        avgdone = avgdone | (result & 0x0202);
        //Check for AVGA and AVGB status bits until both have occurred.
        //Remember, they may not be set together in the same query!
        //Do not check for both in the same query!
    }
    while ((avgdone&0x0202)!=0x0202); // both AVGA and AVGB have occurred
}
/* ***** */
double GetData (int disp, int bin)
{
    //routine to move the display marker to a bin and return the data value

    //move the marker in display disp to bin
    sprintf (cmd,"MBIN %d,%d",disp,bin);
    TxSr780 (cmd);

    sprintf (cmd,"DSPY? %d,%d",disp,bin); //read the data value at bin
    GetSr780 (cmd);
    return (atof(recv)); //return the value as a double
}
/* ***** */
void GetSpace (void) // Wait for space key */

```

5-120 Example Program

```
{
char ch;

while ( kbhit() ) getch(); // clear the keyboard buffer
printf ("\n<Space> to continue, <Q> to quit ");
do {
    ch = (char) getch ();
    if ((ch == 'q') || (ch == 'Q')) exit(0); // exit
}
while (ch != ' '); // continue
printf ("\n");
}
/* ***** */
```

Chapter 6

File Conversions

In This Chapter

Why File Conversion?	6-2
Supported External File Types	6-3
ASCII Files	6-3
SDF Files	6-3
Matlab® MAT-Files	6-3
Universal File Format	6-3
SR780 File Types	6-4
.78D Files	6-4
Buffers: .78C and .78W Files	6-4
Diskfiles and Remote Interface Files: Using SRMERG.EXE	6-4
Using the File Conversion Utility	6-5
Using SRTRANS to Convert Files to .78D to ASCII	6-5
Using SRTRANS to Convert Files to .78W to ASCII	6-6
Using SRTRANS to Convert Files to .78C to ASCII	6-6
Using SRTRANS to Convert Files to .78D to MAT-file	6-7
Using SRTRANS to Convert Files to .78D to Universal File Format	6-7
Using SRBUF to Convert ASCII to .78C	6-8
Using SDFTOSR to Convert SDF to .78D	6-9

Why File Conversion?

Data from the SR780 will often need to be exported to external programs such as spreadsheets, plotting programs, or modal-analysis programs. In addition, it is often convenient to be able to import data prepared by external programs into the SR780 for display and comparison. In order to meet both these needs the SR780 is shipped with a file conversion program designed to import and export data as flexibly as possible

Stanford Research Systems is committed to supporting as many file formats as possible- as a result we are constantly adding new formats. Contact Stanford Research Systems to obtain a list of supported programs and file formats and to obtain a free upgrade to the latest file conversion utilities.

Supported External File Types

Four different file types are currently supported by the SR780 file conversion utilities.

ASCII Files

ASCII files consist of plain ASCII text. ASCII files written by the SR780 file conversion utilities consist of an alphanumeric header with instrument setup information followed by a number of columns of data values. Columns are separated by 'TAB' characters and each line is terminated with a carriage-return line-feed pair. For input, the conversion utilities expect values to be separated by any whitespace character with no leading header data. Characters after the last expected data value are ignored.

SDF Files

Standard Data Format, or SDF, is a file format supported by Hewlett-Packard instruments and is designed to allow data sharing among various analyzers. The SR780 file conversion utilities include a program (SDF2OSR.EXE) to translate version 3.0 SDF files to SRS trace (.78D) files. Note that because of specific differences between HP analyzers and the SR780 it is impossible to exactly match instrument setups on the two analyzers, however, measurement data is transferred exactly.

Matlab® MAT-Files

MATLAB® is a popular program for doing mathematics and for the analysis of numeric data. Although it is easy to import ASCII data directly into MATLAB®, it is faster and more efficient to use the binary MAT-File format. The conversion utilities include the capability of directly converting a SR780 display file into a binary MAT-File.

Universal File Format

The Universal File Format is a specification for an ASCII database capable of describing the geometry, degree-of-freedom, and measurement data used in structural analysis. Most modal analysis programs are capable of importing measurement data formatted in Universal File Format. The SR780 file conversion utilities include the capability of converting SR780 display files into Universal File Type 58 (Function at Nodal DOF) data sets.

SR780 File Types

.78D Files

.78D files, or display files, are generated using the <Trace to Disk> or <Display to Disk> softkeys or by using the TGET?i remote command. The display file contains both the trace data, and a complete record of the instrument's setup when the trace was stored.

Buffers: .78C and .78W Files

The SR780 uses 4 user-allocable buffers to store large amounts of data. These are the Channel 1 capture buffer, the Channel 2 capture buffer, the waterfall buffer, and the arbitrary waveform buffer. Capture and arbitrary waveform buffers have the same format and can be saved to disk as .78C files using the <Buffer to Disk> softkey or the AGET?i and CGET?i,j commands. Waterfall buffers have a different format and can be saved to disk as .78W files using the <Buffer to Disk> softkey or the WGET?i command. The conversion utility can convert ASCII files to .78C files and to convert both .78C and .78W files into ASCII files.

Diskfiles and Remote Interface Files: Using SRMERG.EXE

Because buffers saved to the SR780's internal disk drive with the Buffer to Disk softkey can span several disks, and because it is necessary to record information regarding the total number of disks in the stored file, buffers saved to disk with the Buffer to Disk softkey have a slightly different format from the corresponding buffers which are downloaded using the AGET?I, CGET?I,j or WGET? Remote interface commands. For instance, it would not be possible to save the arbitrary waveform buffer to disk with the <Buffer to Disk> softkey and then upload the saved file using the APUT command.

To provide a means for converting between the diskfile format and the remote interface file format the SRMERG.EXE utility is provided. SRMERG detects the type of its input file and converts its output file to the other format. In the above example, we could run SRMERG on the diskfile and the resulting file would be suitable for uploading with APUT. To use SRMERG type:

```
SRMERG infile outfile
```

Note that both input and output file names must be provided to SRMERG. If either the infile or outfile is a mutidisk floppy file, the program will prompt for insertion of each disk in the correct sequence.

Using the File Conversion Utility

The disk supplied with the SR780 contains the conversion utilities.

SRTRANS.EXE converts .78D files to ASCII, MAT-File and UFF formats as well as converting .78W and .78C files to ASCII only.

SDFTOSR.EXE converts SDF files to .78D files.

SRBUF.EXE converts ASCII files to .78C files.

Using SRTRANS to Convert .78D to ASCII

```
SRTRANS infile [outfile] [/N] [/A] [/D]
```

infile specifies the input .78D filename. Both the filename and extension must be explicitly specified. Wildcard filenames are allowed. For instance SRS00?.78D matches SRS000.78D through SRS009.78D.

outfile optionally specifies the name of the ASCII output file. If *outfile* is omitted an output file with the same name as the input file and an extension of 'ASC' will be created. The default output file consists of a header section with instrument setup information followed by 4 columns of data. The first column gives the data X-axis values, the second and third columns give the real and imaginary parts of the data, and the 4th column gives the value of the selected view of the data.

/N suppresses the output of the fourth data column (view data).

/A appends the ASCII data to the existing outfile instead of overwriting.

/D suppresses the output of the header and creates an ASCII file with data only.

An example of a piece of a converted file follows:

```
Chirp Source: Display A
Arb Src Amp: 100.00 %
Arb Src Buf: Arb. Buffer
Arb Src Rate: 262.1 kHz
Arb Src Start: 0
Arb Src Len: 4 kPts
Input Source: Analog
****DATA BEGINS****
      x      Real      Imag      LogMag
o      -0.0008602436   -3.41401e-006   -61.3075
256    -0.0005861814   -7.750024e-006   -64.6386
512    -0.0001727123   -3.370421e-006   -75.25188
768    -1.977445e-005    1.887184e-006   -94.03854
1024   -4.01275e-006    4.875117e-006  -103.9937
1280    1.377309e-006    9.745545e-006  -100.138
```

Using SRTRANS to Convert .78W to ASCII

SRTRANS *infile* [*outfile*] [/N] [/A] [/D] [/W*atrci-trcj*] [/W*btrci-trcj*]

infile specifies the .78W waterfall buffer files to be converted

outfile optionally specifies the name of the output ascii file. If *outfile* is omitted an output file with the same name as the input file and an extension of 'ASC' will be created. The format is similar to the ASCII file structure described for converted .78D files however SRTRANS includes data for all the traces in a user-specified range within the waterfall buffer. Since waterfall buffers include data for both display A followed by data for the display A waterfall traces followed by a setting header for display B followed by the display B waterfall traces.

/N suppresses the output of the fourth data column (view data).

/A appends the ASCII data to the existing outfile instead of overwriting.

/D suppresses the output of the header for display A and display B.

/W and /Wb specify the range of traces for display A and display B that will be included in the output. For instance, /Wa14-38 instructs the program to translate traces 14 through 38 of the display A waterfall buffer. If this information is not given on the command line it will be prompted for by the program.

Using SRTRANS to Convert .78C to ASCII

SRTRANS *infile* [*outfile*] [/A] [/D]

infile specifies the name of the .78C capture buffer file to be converted.

outfile optionally specifies the name of the output ascii file. If *outfile* is omitted an output file with the same name as the input file and an extension of 'ASC' will be created. The output consists of a header giving settings specific to the capture buffer followed by a single column of data values representing data from the capture buffer.

/A appends the ASCII data to the existing outfile instead of overwriting.

/D suppresses the output of the capture buffer header.

An example of a piece of a converted .78C file follows:

```
Time: 14:17:26
Date 7/23/96
Length: 2 kPts
Base Freq: 102.4 kHz
Sampling Freq: 262.1 kHz
Input Range Ch1: 0 dBv
Input Range Ch2: 0 dBv
-0.4461670
-0.4826355
-0.4906464
-0.4691315
-0.4194641
-0.3446960
-0.2493286
-0.1390076
```

Using SRTRANS to Convert .78D to MAT-File

SRTRANS *infile* [*outfile*] /M

infile specifies the name of the .78D filename. Both the filename and extension must be explicitly specified.

outfile optionally specifies the name of the output .MAT output file. If *outfile* is omitted an output file with the same name as the input file and an extension of 'MAT' will be created.

The converted MAT-file can be loaded into the MATLAB® workspace using the 'load' command. The MAT-file contains one matrix with 4 columns and a number of rows equal to the number of points in the original .78D file. The first column contains X-axis values, the second and third columns contain the real and imaginary parts of the measurement data, and the 4th column contains the value of the selected view.

Using STRANS to Convert .78D to Universal File Format

SRTRANS *infile* [*outfile*] /U [/A] [*Fcfgfile*] [/P*i,j,k,l,m,n*]

infile specifies the .78D file to be converted. Infile may contain wildcard characters if a set of .78D files is to be converted.

outfile may be either the name of a single file, in which case all input files will be translated and appended to the single output file, or may be the wildcard *.ext, where each input file will be translated into an output file with the same name and the extension ext.

/A specifies that output should be appended to an existing file instead of overwriting.

/F*cfgfile* specifies the name of a configuration file. A configuration file is a text file containing a list of input file names optionally followed by a set of nodal DOF parameters. SRTRANS will convert any files specified in the configuration file in addition to any files specified by *infile*. If DOF parameters are given in the input file they override any DOF parameters stored with the .78D file.

/P*i,j,k,l,m,n* specifies a list of nodal DOF parameters to use in the conversion which will override DOF parameters stored in the input .78D files. *i,j,k,l,m,n* are respectively the response node name, id#, direction followed by the reference node name, id#, and direction. Node direction is specified according to the following table.

<u>i</u>	Node Direction
----------	----------------

6-8 Using the File Conversion Utilities

0	-θ Z
1	-θ Y
2	-θ X
3	-Z
4	-Y
5	-X
6	Scalar (no direction)
7	X
8	Y
9	Z
10	+θ X
11	+θ Y
12	+θ Z

Example:

```
C:>STRANS SRS??.78D OUT.UFF /U /A /Fcfile
where cfile contains the lines;
```

```
XYZ.78DD NODE1,1,8,NODE2,2,8
QXR.78D
```

will translate all files in the current directory matching SRS??.78D using the DOF information stored in those files into a single output file OUT.UFF. In addition, because a configuration file is given on the command line, SRTRANS will translate the file XYZ.78D with the DOF information specified in the configuration file (response name = NODE1, response id#=1, response direction =+X, reference node=NODE2, reference in=2, reference direction =+Y) and the file QXY.78D will be translated using DOF information stored in the input file. Output from these to files will be appended to OUT.UFF.

Using SRBUF to Convert ASCII to .78C

```
SRBUF infile outfile [/Bn] [/Li] [/Sn] [/Xi] [/YI]
```

infile specifies the ASCII file to be converted. The file consists of a list of ASCII floating point numbers separated by whitespace characters. If the file is to be uploaded to a capture buffer, the floating point values correspond to a fraction of the full scale input voltage specified in the capture header. If the file is to be uploaded to the arbitrary waveform buffer then a value of 1.000 corresponds to a one volt output at the source when the Arb Amplitude softkey is set to %100.0.

outfile specifies the name of the converted .78C file. The resultant file is suitable for uploading to arbitrary waveform buffer using the APUT? Command or to the capture buffers using the CPUT?i command. To load the output file from a floppy disk it is necessary to convert I to floppy format with the SRMERG utility.

The remainder of the switches allow the user to set information in the capture header corresponding to the file.

/B*n* specifies the Base Frequency. 0=100 kHz, 1-102.4 kHz

/Li specifies the buffer length in kiloPoints

/Sn specifies the capture sampling frequency. $F_s = \text{Base} * 2.56 / (2^n)$.

/Xi and */Yi* specify the Ch1 and Ch2 full scale input ranges respectively in dBV. These values are ignored if the file is uploaded to the arb waveform buffer.

Using SDFTOSR to Convert SDF to .78D

SDFTOSR *infile outfile /Vn*

infile specifies SDF file to be converted.

outfile specifies the name of the converted .78D file.

/Vn specifies the version of your SR780 instrument. You can find the version number of the instrument by pressing the [system]<Show Version> softkey on the SR780. For example use */V109* for SR780 version 109.

Note that since there is not a one to one correspondence between fields in the SDF file and settings of the SR780, and exact transfer of instrument settings is not feasible. However, SDFTOSR is a reliable means of importing *data* stored in an SDF file into the SR780.



ADDENDUM

Instructions for using the SR780/SR785 USB Drive

1.44 Mb floppy drives are obsolete. The USB drive is now standard on the SRS780/SR785 Network analyzers.

There is no need to use a large capacity USB flash drive. The instrument treats the USB drive as a 1.44 Mb floppy drive.

You can format your USB drive with a windows computer to delete all files on your drive, however the USB drive must be formatted by the SR780/SR785 for the instrument to recognize the drive.

The USB drive installed in the SR780/SR785 has the capacity to create multiple drives. There are two buttons on the far left of the drive. The right button increments the drive number by one. The left button increments the drive number by 10. You can use multiple drive numbers, however each drive number must be formatted by the instrument.

The photo below shows the drive being formatted for drive 000.

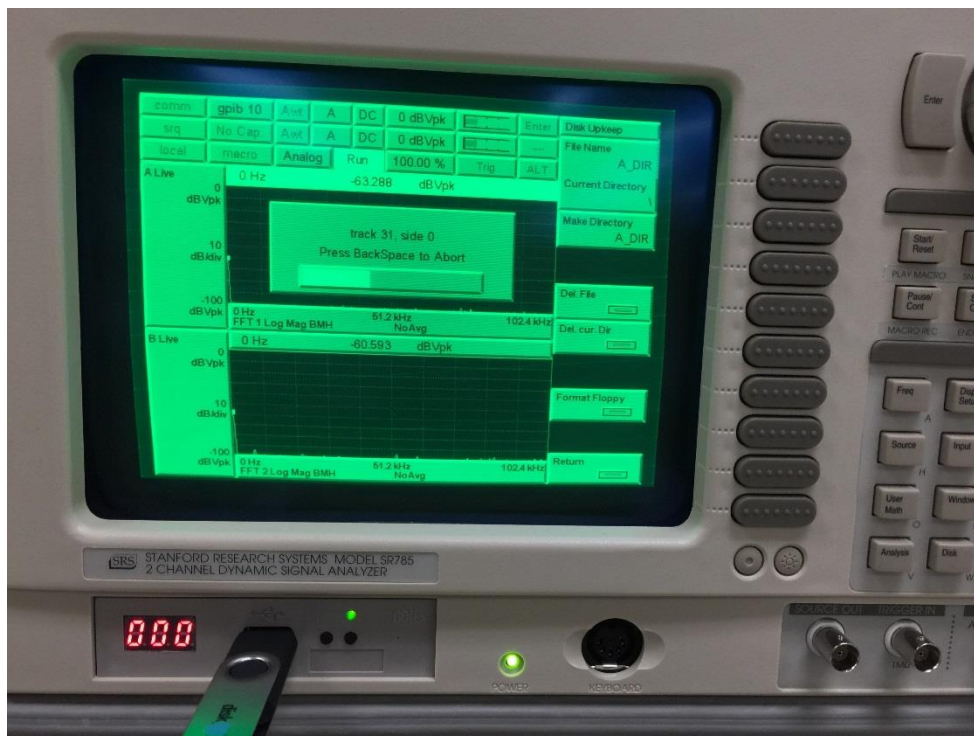

The next photo shows the drive being formatted to 31.

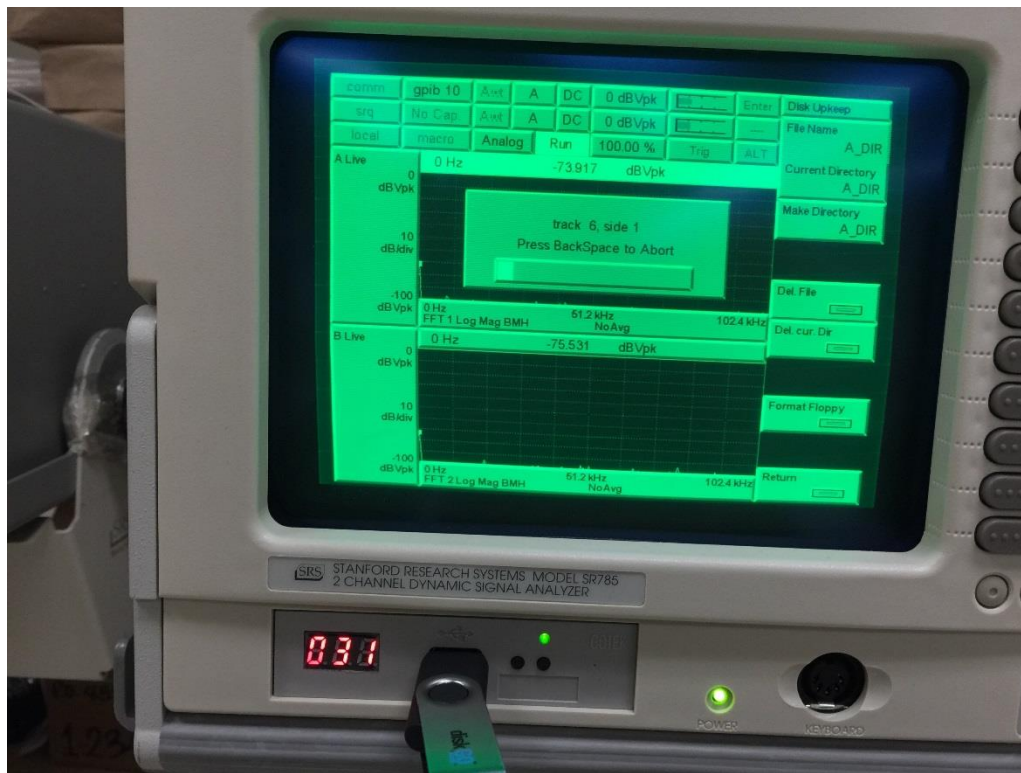

The SR780/SR785 can now retrieve data and settings from drive 000 (if the drive is set to 000) and it can retrieve data from drive 031 (if the drive is set to 031).

Only drive 000 can be read by a Windows 7 or Windows XP computer. All other drives will be ignored.

The first drive should be 000. If you want to use the data on your computer, or backup your settings to your computer, the files must be in drive 000, no other drive will be seen.