

Operation and Service Manual

# Analog Lock-In Amplifier

---

**SR124**



Stanford Research Systems

---

Revision 1.03 • July 12, 2018

---

## Certification

Stanford Research Systems certifies that this product met its published specifications at the time of shipment.

## Warranty

This Stanford Research Systems product is warranted against defects in materials and workmanship for a period of one (1) year from the date of shipment.

## Service

For warranty service or repair, this product must be returned to a Stanford Research Systems authorized service facility. Contact Stanford Research Systems or an authorized representative before returning this product for repair.

Information in this document is subject to change without notice.

Copyright © Stanford Research Systems, Inc., 2012 – 2018. All rights reserved.

Stanford Research Systems, Inc.  
1290–D Reamwood Avenue  
Sunnyvale, CA 94089 USA  
Phone: (408) 744-9040 • Fax: (408) 744-9049  
**www.thinkSRS.com • e-mail: info@thinkSRS.com**

Printed in U.S.A.

Document number 9-01688-903



SR124 Analog Lock-In Amplifier

---

# Contents

---

<b>General Information</b>	<b>v</b>
Safety and Preparation for Use . . . . .	v
Symbols . . . . .	vi
Notation . . . . .	vii
Specifications . . . . .	viii
<b>1 Getting Started</b>	<b>1 – 1</b>
1.1 How to use this manual . . . . .	1–2
1.2 Basic instrument check-out . . . . .	1–2
1.2.1 Equipment needed . . . . .	1–2
1.3 Preparations before use . . . . .	1–2
1.4 Signal and input filter . . . . .	1–3
1.5 Phase sensitive detector . . . . .	1–4
1.6 Reserve . . . . .	1–5
1.7 Output offset . . . . .	1–6
1.8 Reference oscillator external input . . . . .	1–7
1.9 Reference oscillator output . . . . .	1–8
<b>2 Introduction</b>	<b>2 – 1</b>
2.1 Introduction to the instrument . . . . .	2–2
2.1.1 Clock stopping architecture . . . . .	2–2
2.1.2 What does the SR124 measure? . . . . .	2–2
2.2 Instrument overview . . . . .	2–3
2.2.1 Reference section . . . . .	2–3
2.2.2 Signal section . . . . .	2–6
2.2.3 Input Filter . . . . .	2–9
2.2.4 Output . . . . .	2–10
2.3 Navigating the front panel . . . . .	2–11
2.3.1 Signal input section . . . . .	2–12
2.3.2 Output section . . . . .	2–15
2.3.3 Setup section . . . . .	2–16
2.3.4 Reference section . . . . .	2–18
<b>3 Performance Details</b>	<b>3 – 1</b>
3.1 Sensitivity and gain . . . . .	3–2
3.1.1 AC Gain . . . . .	3–2
3.1.2 Scale normalization . . . . .	3–3

3.1.3	DC gain . . . . .	3-4
3.2	Dynamic reserve and overloads . . . . .	3-4
3.3	Input filter details . . . . .	3-6
3.4	Attenuators and DC bias constraints . . . . .	3-9
3.5	Automatic functions . . . . .	3-9
3.5.1	Auto-phase . . . . .	3-9
3.5.2	Auto-gain . . . . .	3-10
3.5.3	Auto-offset . . . . .	3-10
3.5.4	Lock assist . . . . .	3-10
<b>4</b>	<b>Remote Operation</b>	<b>4-1</b>
4.1	Index of commands . . . . .	4-2
4.2	Alphabetic list of commands . . . . .	4-4
4.3	Introduction . . . . .	4-6
4.3.1	Interface configuration . . . . .	4-6
4.3.2	Buffers . . . . .	4-6
4.3.3	Remote / local . . . . .	4-6
4.4	Commands . . . . .	4-7
4.4.1	Command syntax . . . . .	4-7
4.4.2	Notation . . . . .	4-8
4.4.3	Examples . . . . .	4-8
4.4.4	Reference and phase commands . . . . .	4-9
4.4.5	Input commands . . . . .	4-11
4.4.6	Filter commands . . . . .	4-12
4.4.7	Gain and time constant commands . . . . .	4-13
4.4.8	Output commands . . . . .	4-14
4.4.9	Setup commands . . . . .	4-15
4.4.10	Auto commands . . . . .	4-16
4.4.11	Data transfer commands . . . . .	4-17
4.4.12	Interface commands . . . . .	4-18
4.4.13	Status commands . . . . .	4-20
4.5	Status model . . . . .	4-23
4.5.1	Status byte (SB) . . . . .	4-23
4.5.2	Service request enable (SRE) . . . . .	4-24
4.5.3	Standard event status (ESR) . . . . .	4-24
<b>5</b>	<b>Circuits</b>	<b>5-1</b>
5.1	Overview of circuits . . . . .	5-2
5.2	Power Supply . . . . .	5-2
5.3	CPU . . . . .	5-2
5.4	Front Panel . . . . .	5-2
5.5	Main board . . . . .	5-2

---

5.6	Oscillator . . . . .	5-4
5.7	Rear outputs . . . . .	5-5
5.8	Communications . . . . .	5-5
5.9	Schematics . . . . .	5-5



---

## General Information

---

### Safety and Preparation for Use



#### WARNING

**Dangerous voltages, capable of causing injury or death, are present in this instrument. Do not remove the product covers or panels. Do not apply power or operate the product without all covers and panels in place.**

### AC line voltage

The SR124 Analog Lock-In Amplifier operates from a 100 V, 120 V, 220 V, or 240 V nominal AC power source having a line frequency of 50 Hz or 60 Hz. Before connecting the power cord to a power source, verify that the LINE VOLTAGE SELECTOR, located in the rear panel power-entry module, is set so that the correct AC line voltage value is visible.



#### CAUTION

The SR124 Analog Lock-In Amplifier will be damaged if operated with the LINE VOLTAGE SELECTOR set for the wrong AC line voltage, or if the wrong fuses are installed. Verify that the correct line fuses are installed before connecting the line cord. Fuse size is 5MF “fast blow” ( $\varnothing 5 \times 20$  mm). For 100 V/120 V, use 4 A fuses; for 220 V/240 V, use 2 A fuses.

### Line cord









The SR124 Analog Lock-In Amplifier has a detachable, three-wire power cord for connection to the power source and to a protective ground. The chassis of the instrument is connected to the outlet ground to protect against electrical shock. Always use an outlet which has a properly connected protective ground.

### Service

The SR124 Analog Lock-In Amplifier does not have any user serviceable parts inside. Refer service to a qualified technician.

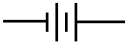
Do not install substitute parts or perform any unauthorized modifications to this instrument. Contact the factory for instructions on how to return the instrument for authorized service and adjustment.

### Symbols you may Find on SRS Products

Symbol	Description
	Alternating current
	Caution - risk of electric shock
	Frame or chassis terminal
	Caution - refer to accompanying documents
	Earth (ground) terminal
	Battery
	Fuse
	On (supply)
	Off (supply)



## Notation

The following notation will be used throughout this manual.



### WARNING

A warning means that injury or death is possible if the instructions are not obeyed.



### CAUTION

A caution means that damage to the instrument or other equipment is possible.

Typesetting conventions used in this manual are:

- Front-panel buttons are set as [Button]
- Front-panel knobs are set as Knob
- Front-panel indicators are set as *Overload*
- Remote command names are set as \*IDN?
- Literal text other than command names is set as OFF

Remote command examples will all be set in monospaced font. In these examples, data sent by the host computer to the SR124 are set as `straight teletype font`, while responses received by the host computer from the SR124 are set as *slanted teletype font*.

## Specifications

All performance specifications after 1 hour warm-up at 23 °C ±2 °C ambient.

### Signal channel

Parameter	Specification
Voltage inputs	Single-ended or differential
Sensitivity	100 nV to 500 mV, in 1-2-5 steps
Current input	10 <sup>6</sup> V/A or 10 <sup>8</sup> V/A
Input impedance	
Voltage	10 MΩ + 25 pF, AC or DC coupled
Current	100 Ω (1 kΩ) to virtual ground, 10 <sup>6</sup> (10 <sup>8</sup> ) V/A scale
Gain accuracy	±1% at 1 kHz
Gain stability	100 ppm/°C (flat mode, normal reserve)
Input noise, typ.	2.8 nV/√Hz at 1 kHz 0.14 pA/√Hz at 1 kHz (10 <sup>6</sup> V/A) 0.014 pA/√Hz at 100 Hz (10 <sup>8</sup> V/A)
Input filter	(Tunable from 2 Hz to 100 kHz)
Flat	Flat within ±1% from 10 Hz to 20 kHz ±5% from 2 Hz to 100 kHz
Band pass	Q of 1, 2, 5, 10, 20, 50, and 100
High pass	-12 dB/oct rolloff
Low pass	-12 dB/oct rolloff
Notch	Up to 80 dB attenuation
CMRR	90 dB below 10 kHz, DC coupled decreasing by 6 dB/oct above 10 kHz
Dynamic reserve	(without band pass filter)
Low noise	20 dB
Normal	40 dB
High reserve	60 dB

**Demodulator / Output**

Parameter	Specification
Output gain stability	
Low noise	50 ppm/°C
Normal	100 ppm/°C
High reserve	1000 ppm/°C
Output filter	–6 dB/oct or –12 dB/oct
Time constants	1 ms to 300 s in 1–3–10 steps
Output impedance	600 $\Omega$

**Reference channel**

Parameter	Specification
Frequency range	0.2 Hz to 210 kHz
Reference input	TTL or sine, 100 mVrms min. $f > 2$ Hz, 500 mVrms min. $f \leq 2$ Hz locks to positive-going zero crossing (sine), positive edge (TTL).
Minimum pulse width	100 ns (TTL mode)
Input impedance	1 M $\Omega$ AC coupled, 10 s time constant (sine) DC coupled (TTL)
Phase resolution	0.01°
Phase accuracy	$\pm 5^\circ$ (2 Hz to 20 kHz) $\pm 10^\circ$ (20 kHz to 210 kHz)
Harmonic detection	F, 2×F, and 3×F (ext. ref.)

**Reference output**

Parameter	Specification
Range	0.2 Hz to 210 kHz
Waveform	sine, square
Frequency accuracy	$\pm 0.1\%$ (20 Hz to 21 kHz)
Frequency resolution	3-1/2 digits or 1 mHz
Amplitude range	100 nV to 10 Vrms into high-Z
Amplitude accuracy	$\pm 1\%$ at 1 kHz (on 20 Hz to 2.1 kHz range)
Amplitude flatness	$\pm 1\%$ for upper decade of each range $\pm 5\%$ for lower decade of each range
Amplitude stability	50 ppm/°C, typ.
Output impedance	50 $\Omega$
DC bias	commandable, to $\pm 10\times$ amplitude, or $\pm 10$ VDC max (amp. dependent; see section 3.4 for details)

**Displays and Front Panel**

Parameter	Specification
Panel meter	jeweled bearing, center-zero, mirror-backed
Offset	adjustable up to $\pm 1000\%$ (10 $\times$ ) of full scale
Output	600 $\Omega$ output impedance, Lock-In or AC Volt function
Numeric	full static drive (no scanning refresh), settings or one-time readings

**Rear panel inputs and outputs**

Parameter	Specification
VCO input	10 k $\Omega$ input impedance 0 to +10 VDC for $f_{\min}$ to $f_{\max}$ of range
VCO output	600 $\Omega$ output impedance, 0 to +10 VDC
Quadrant outputs	600 $\Omega$ output impedance Four 0.7 V <sub>rms</sub> (2 V <sub>pp</sub> ) outputs, at 0°, 90°, 180°, 270°
Preamp	DB-9 connector to power optional remote preamp
Status	TTL outputs, 1 k $\Omega$ output, 10 k $\Omega$ pullup
–Unlocked	low when reference oscillator is unlocked
–Overload	low when signal chain is overloaded
Remote Interfaces	
RS-232	DB-9, 9600 baud fixed
Optical fiber	connection to SX199 Optical Interface Controller, provides connectivity to GPIB, RS-232, & Ethernet

**General**

Parameter	Specification
Temperature	0 °C to 40 °C, non-condensing
Power	40 W, 100/120/220/240 VAC, 50/60 Hz
Dimensions	17" W $\times$ 5" H $\times$ 15" D
Weight	23 lbs
Fuse	Type 5MF, $\varnothing 5 \times 20$ mm, "fast blow"

---

# 1 Getting Started

---

This chapter provides step-by-step instruction to get started quickly with the SR124 Analog Lock-In Amplifier. Refer to chapter 2 for a more complete introduction to the SR124.

## In This Chapter

<b>1.1</b>	<b>How to use this manual . . . . .</b>	<b>1-2</b>
<b>1.2</b>	<b>Basic instrument check-out . . . . .</b>	<b>1-2</b>
1.2.1	Equipment needed . . . . .	1-2
<b>1.3</b>	<b>Preparations before use . . . . .</b>	<b>1-2</b>
<b>1.4</b>	<b>Signal and input filter . . . . .</b>	<b>1-3</b>
<b>1.5</b>	<b>Phase sensitive detector . . . . .</b>	<b>1-4</b>
<b>1.6</b>	<b>Reserve . . . . .</b>	<b>1-5</b>
<b>1.7</b>	<b>Output offset . . . . .</b>	<b>1-6</b>
<b>1.8</b>	<b>Reference oscillator external input . . . . .</b>	<b>1-7</b>
<b>1.9</b>	<b>Reference oscillator output . . . . .</b>	<b>1-8</b>

## 1.1 How to use this manual

Two possible starting points are available to new users of the SR124. Those who want to begin with an overview to the functional layout of the instrument should turn to Chapter 2.

Users who prefer to jump in and begin using the SR124 first should continue with this Chapter, where a series of step-by-step procedures are given to verify the basic performance of the instrument. This will also provide a quick introduction to the SR124 and how it is operated.

Chapter 3 provides detailed discussions of the subsystems within the SR124. Technical details, such as the actual gain allocations for each sensitivity and reserve setting, can be found here.

Chapter 4 discusses remote operation of the SR124, over the optical fiber or RS-232 interface.

Chapter 5 has a description of the detailed circuit schematics of the SR124.

## 1.2 Basic instrument check-out

This chapter provides step-by-step instructions for verifying the basic operation of the SR124. In addition to confirming proper operation, it provides a good introduction to operating the lock-in.

### 1.2.1 Equipment needed

To perform all the steps described in this chapter, you will need:

1. a collection of several BNC cables,
2. a function generator,
3. a general purpose 2-channel oscilloscope.

## 1.3 Preparations before use



### CAUTION

1. Before using the instrument, verify the rear-panel power entry module is properly configured for the power line voltage in your region. Applying power with improper setting of the line voltage selector will result in significant damage to the SR124.
2. Turn the rear-panel Power switch to off.
3. Plug in the AC line cord to the rear-panel power entry module, and into a grounded wall outlet.

4. Connect a BNC cable from the front-panel Ref Out BNC (right-hand most connector) to the A/I input of the Signal Input (left-hand most connector).
5. Switch on the AC power. Allow the unit to warm up for 1 hour for full specified performance.

## 1.4 Signal and input filter

1. Restore defaults: Press [Recall], and then turn the **REFERENCE** knob (large right-hand side knob) clockwise until the display shows "deFLt". Press [Recall] a second time to restore factory defaults.
2. Verify the panel meter shows approximately +20% (positive) deviation.
3. Turn the **SENSITIVITY** knob counterclockwise 2 clicks, to select 100 mV. Verify the meter displays approximately +100% (positive) deviation.
4. Change the filter to Notch by pressing the [Type] button four times. The meter should swing to approximately 0% deviation.
5. Turn the **Q-factor** knob clockwise until Q=100. The meter should remain near 0% deviation.
6. Press the [Mode] button in the OUTPUT block to switch to AC Volt mode. Turn the **SENSITIVITY** knob 1 click counterclockwise, to select 50 mV. None of the overload indicators should be illuminated.
7. Slowly (one click at a time) turn the large **INPUT FILTER** knob to minimize the meter display as close to 0 (no deflection) as possible.
8. Press the **INPUT FILTER** knob inward once, to illuminate the *f trim* indicator.
9. Adjust the frequency fine trim by turning **INPUT FILTER** to minimize the meter deflection (minimum is not very sensitive to *f trim*).
10. Press the **INPUT FILTER** inward once more, to illuminate the *depth* indicator.
11. Adjust the depth trim by turning **INPUT FILTER** to minimize the meter deflection (minimum is somewhat sensitive to *depth*).

12. Turn the **SENSITIVITY** knob counterclockwise 2 clicks, to 10 mV. Verify the meter displays less than  $\pm 20\%$  deviation. Repeat trimming frequency and depth with the **INPUT FILTER** knob to minimize the meter deflection. The meter should be less than  $\pm 10\%$  deviation.
13. Turn **SENSITIVITY** 3 clicks clockwise, back to 100 mV. Press [Mode] to return the output to Lock-In mode.
14. Press the [Type] button twice, to select Band Pass. The meter should be near  $-100\%$  deviation.
15. Perform an auto-phase adjustment by pressing the [Phase] button within the AUTO block. After a brief delay, the REFERENCE display should show near 180 deg, and the panel meter should show  $+100\%$  deviation.
16. Press the [Type] button again to select High Pass filter. The panel meter should move near 0 deflection.
17. Perform another auto-phase adjustment by pressing [Phase] in the AUTO block. After the pause, the phase should show a value near 90 deg, and the meter should return to near  $+100\%$  deflection.
18. Press the [Type] button again to select Low Pass filter. The meter should swing to near  $-100\%$  deflection.
19. Perform another auto-phase adjustment by pressing [Phase] in the AUTO block. After the pause, the phase should show a value near 270 deg, and the meter should return to near  $+100\%$  deflection.

## 1.5 Phase sensitive detector

This section walks you through a demonstration of how the phase sensitive detector (square wave mixer) operates. You will need an oscilloscope to view the output waveforms.

A BNC cable should connect the Reference Output (Ref. Out) to the A/I signal input. Connect the OUTPUT BNC to the oscilloscope.

1. Restore default settings by pressing [Recall]; turn **REFERENCE** if necessary to display "deFLt", and then press [Recall] again.
2. Change the reference frequency from 1.000 kHz to 100 Hz by turning the **Range** knob counterclockwise one click. Turn the large **REFERENCE** knob counterclockwise to set the frequency to 47 Hz.



3. Perform an auto-phase adjustment by pressing the [Phase] button within the AUTO block. After a brief delay, the REFERENCE display should show near 0 deg.
4. Turn the **Time Constant** knob counterclockwise to the *min* position. Adjust the scope for 1 V per vertical division, and around 2.5 ms per horizontal division, and adjust the trigger. You should see a fully-rectified positive sine wave, as shown in Figure 1.1.

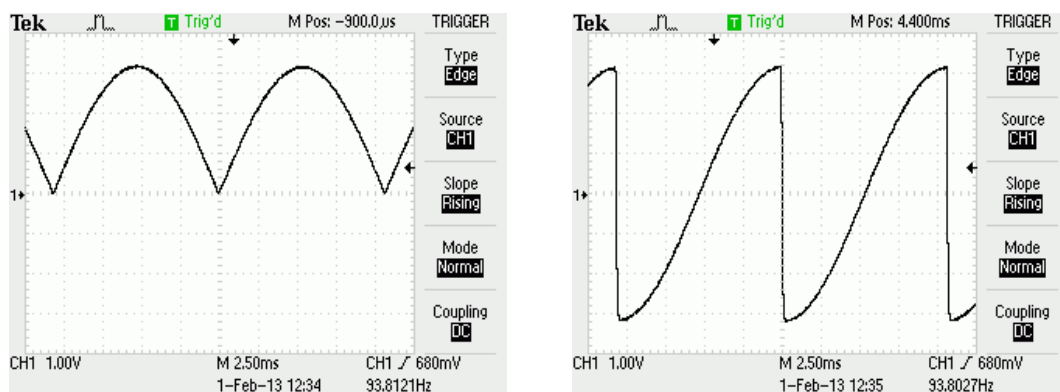

Figure 1.1: Mixer waveform at 0° (left) and 90° phase shifts (right).

5. Turn the **Quadrant** knob one click clockwise. The signal is now 90° out of phase with the reference signal, as shown in Figure 1.1.
6. Turn the **Quadrant** knob one click clockwise. The signal is now at 180° relative to the reference signal, as shown in Figure 1.2.
7. Turn the **Quadrant** knob one click clockwise. The signal is now 270° out of phase with the reference signal, as shown in Figure 1.2.

## 1.6 Reserve

1. Restore default settings by pressing [Recall]; turn **REFERENCE** if necessary to display "deFLt", and then press [Recall] again.
2. Perform an auto-phase adjustment by pressing [Phase] in the AUTO block. After the pause, the phase should show a value near 0 deg.

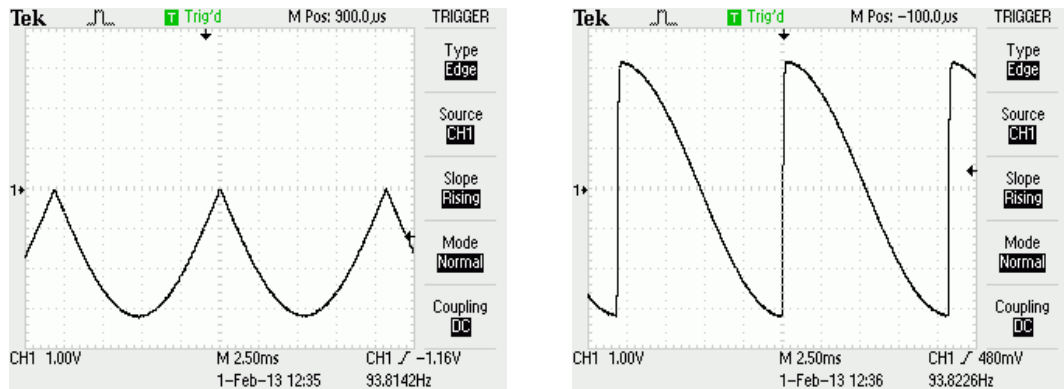

Figure 1.2: Mixer waveform at 180° (left) and 270° phase shifts (right).

3. Turn **SENSITIVITY** 2 clicks counterclockwise, to 100 mV. The meter should read near +100% deflection
4. Turn **Quadrant** (in the Reference section) one click clockwise, to the 90–180 interval. The meter should be near 0 deflection.
5. Turn **SENSITIVITY** 3 clicks counterclockwise, to 10 mV. The meter should still read between –30% and +30% deviation, with no overload indicators.
6. Turn **SENSITIVITY** 1 click counterclockwise, to 5 mV. The sensitivity *OVL*D indicator should light.
7. Press [Reserve] twice, to select *Normal*. The *OVL*D indicator should turn off. Manually adjust the phase setting (with the **REFERENCE** knob) to null the meter. Turn **SENSITIVITY** 2 more clicks counterclockwise, to 1 mV. *OVL*D should remain off. Turn **SENSITIVITY** once more, to 500 µV. *OVL*D should light.
8. Press [Reserve] twice again, to select *High Res*. *OVL*D should turn off. Manually adjust the phase setting again to null the meter. Turn **SENSITIVITY** 2 more clicks counterclockwise, to 100 µV. You may try to further null the signal by manually adjusting the phase setting again, although the signal may be unstable with so much gain.

## 1.7 Output offset

1. Restore default settings by pressing [Recall]; turn **REFERENCE** if necessary to display "deFLt", and then press [Recall] again.

2. Press [Ampl] in the Reference section, and turn the **REFERENCE** knob counterclockwise until the numeric display shows 95.0 mV.
3. Turn **SENSITIVITY** 2 clicks counterclockwise, to 100 mV. The meter should read near +95% deflection
4. Enable the output offset by pressing [On/Off] in the OFFSET block. Perform an auto-offset adjustment by pressing [Offset] in the AUTO block. After the pause, the offset should show a value near +95% offset. The panel meter should read near zero.
5. Turn **SENSITIVITY** 2 more clicks counterclockwise, to 20 mV. The panel meter should still read near zero, while the REFERENCE display shows a value near +475%.
6. Turn **SENSITIVITY** 1 click counterclockwise, to 10 mV. The REFERENCE display should read near +950%, and the panel meter should still be near null.
7. Turn **SENSITIVITY** 1 click further counterclockwise. The display should show the message "Attn OFFSt", and the *OFFSET* annunciator in the REFERENCE display block should blink. The sensitivity does not change.
8. Press the [Ampl] button, and reduce the amplitude to 90.0 mV. The panel meter should show around -50% full scale deflection.
9. Press the [Offset] button in the AUTO block again, to automatically re-adjust the offset. The REFERENCE display should now show near +900%, and the panel meter should be nulled.

## 1.8 Reference oscillator external input

1. Restore default settings by pressing [Recall]; turn **REFERENCE** if necessary to display "deFLt", and then press [Recall] again.
2. Set the function generator to produce a 1 Vrms, 2 kHz sine wave. Connect the function generator output to the SR124 "Ext. In" BNC, in the REFERENCE section.
3. Turn the **Mode** knob in the REFERENCE section one click clockwise, to the *f External* setting. The *Unlocked* indicator should illuminate for between 5 and 20 seconds, and then the SR124 should lock to the external signal.
4. Press [Freq] in the REFERENCE section to perform an oscillator frequency measurement. After a brief delay, the REFERENCE

display should show a value near 2.00 kHz.

5. Turn **Mode** back to *Internal*, and then turn it back to *f External*. Immediately after turning the mode to external, press [Lock Assist] in the AUTO section. The display should show “ASSt Loc”, and then the SR124 should lock, displaying the external frequency .
6. Turn **Mode** to *2f External*, and then press [Lock Assist]. The display should show “ASSt Loc”, and then “Err outr”, indicating the frequency is out of range for the oscillator.
7. Turn the **Range** knob clockwise one click to select 200–21k. After a few seconds, the oscillator should lock. Press [Freq] to measure the oscillator; the result should be near 4.000 kHz.
8. Turn **Mode** again, to *3f External*, and press [Lock Assist]. The REFERENCE display should show the result near 6.000 kHz.

## 1.9 Reference oscillator output

1. Restore default settings by pressing [Recall]; turn **REFERENCE** if necessary to display “deFLt”, and then press [Recall] again.
2. Connect a BNC cable from the rear-panel Reference Output 0° to the Channel 1 of the oscilloscope. Trigger the scope on the waveform, and verify a 1 kHz, 0.7 Vrms (2 V peak-to-peak) sine wave.
3. Connect a second BNC cable from the rear-panel Reference Output 90° to Channel 2 of the scope. Verify the Channel 2 signal lags Channel 1 by 90°.
4. Disconnect the cable from the rear-panel 90° output, and connect it to the 180° output. Verify the Channel 2 signal on the scope appears inverted relative to Channel 1 (lagging by 180°).
5. Disconnect the cable from the rear-panel 180° output, and connect it to the 270° output. Verify the Channel 2 signal on the scope lags Channel 1 by 270° (leading by 90°).
6. Disconnect the Channel 2 BNC from the rear-panel of the SR124, and connect it to the front-panel Ref. Out BNC.
7. Press the [Ampl] button. Press the **REFERENCE** knob in once, to select *coarse*, and then turn **REFERENCE** clockwise until the display reads 10.00 V. Verify on the oscilloscope that Channel 2 shows a sine wave of approximately 10 Vrms (28 V peak to peak). The signal should be in-phase with Channel 1.

8. Press [Shape] to select *Square*. Verify the waveform changes to a square wave with  $\pm 10$  V (20 V peak to peak).
9. Turn the **REFERENCE** knob counterclockwise, to reduce the amplitude to 1.00 V on the REFERENCE display. Press [Shape] to return to *Sine* output.
10. Enable the DC bias by pressing [On/Off] in the DC Bias block. Press [Modify] in DC Bias, and then adjust the Bias setting by turning **REFERENCE** counterclockwise, to near  $-2.000$  V. Verify the waveform on the scope is now shifted to an average of  $-2$  V.
11. Press the DC Bias [On/Off] to turn off the bias, and verify the waveform returns to zero-centered. Press DC Bias [On/Off] again to re-enable the  $-2$  V DC Bias.
12. Press the [Ampl] button to select Amplitude again, and then turn **REFERENCE** counterclockwise until you reach the limit. Turn the knob slow counterclockwise to reach 10.0 mV. Notice that the SR124 will not allow the Amplitude to decrease below 10.0 mV with the DC Bias enabled and set to  $-2$  V.
13. Press DC Bias [On/Off] to disable the Bias. With the REFERENCE focus still on Amplitude, turn **REFERENCE** counterclockwise to 9.99 mV. Notice the sound of the relay click.
14. Now press DC Bias [On/Off] to attempt to re-enable the Bias. The SR124 should beep, and the *AMPL* annunciator will flash, indicating the present value of Amplitude is incompatible with (too small for) the requested ( $-2$  V) DC Bias.
15. Press DC Bias [Modify]. The old value ( $-2$  V) should be displayed, but the SR124 beeps in warning that this value is presently unaccessable. Turn the **REFERENCE** knob in either direction; the displayed BIAS value will jump to  $-100$  mV. This is the limiting value for DC Bias when the amplitude is between 0.1 mV and 9.99 mV. Full details of the interdependence of DC bias and Amplitude can be found in section 3.4.



---

## 2 Introduction

---

This chapter provides a basic overview of the SR124 Analog Lock-In Amplifier.

### In This Chapter

<b>2.1</b>	<b>Introduction to the instrument</b>	<b>2-2</b>
2.1.1	Clock stopping architecture	2-2
2.1.2	What does the SR124 measure?	2-2
<b>2.2</b>	<b>Instrument overview</b>	<b>2-3</b>
2.2.1	Reference section	2-3
2.2.2	Signal section	2-6
2.2.3	Input Filter	2-9
2.2.4	Output	2-10
<b>2.3</b>	<b>Navigating the front panel</b>	<b>2-11</b>
2.3.1	Signal input section	2-12
2.3.2	Output section	2-15
2.3.3	Setup section	2-16
2.3.4	Reference section	2-18

## 2.1 Introduction to the instrument

Lock-in amplifiers are used to detect and measure very small AC signals, often in the presence of noise sources that can be orders of magnitudes larger. Typical lock-in amplifiers today are based on high-speed digital signal processing (DSP) techniques. This offers outstanding performance and flexibility for many, perhaps most, applications. For certain demanding situations, however, residual artifacts from the DSP approach—either due to sampling lag and real-time response, or RF clock and related noise—can fall short of users needs.

The SR124 is a modern, all-analog lock-in amplifier that provides outstanding signal recovery capabilities, without the shortcomings that can limit the usefulness of more common DSP-based instruments. The design follows two basic themes. First, the signal path is entirely built from low-noise analog electronics: the best JFETs, transistors, op-amps, and discrete components. Second, configuration control is managed by a microcontroller whose system clock only oscillates during the brief moments needed to change gains or filter settings.

### 2.1.1 Clock stopping architecture

This “clock-stopping” architecture, first introduced by SRS in the SR560 Voltage Preamplifier, eliminates the inconvenience and reliability issues associated with mechanical panel controls, and makes full remote operation of the SR124 possible. Whenever the microcontroller becomes active, the *CPU Activity* indicator illuminates, clearly showing when the digital clock is running. This occurs in response to front-panel button presses or remote computer commands.

Sometimes, you need to be certain your experiment will be undisturbed: you’ve cooled your sample to a few millikelvin, all your wiring is still intact, and the best device you’ve built all year is ready for measurement. A locking toggle switch on the front panel can be set to “INHIBIT”, forcing the digital clock to remain off, even if you press other buttons or knobs. The analog configuration of the SR124 stays steady, letting you run for minutes, hours, days—as long as you need.

### 2.1.2 What does the SR124 measure?

In lock-in mode, the SR124 multiplies the input signal by a square wave at the reference frequency, using a square-wave analog mixer. The resulting signal is then low-pass filtered to produce an output proportional to the frequency component of the user’s input signal at the reference frequency (and also, to a diminishing extent, at its odd



harmonics). This process is also known as phase-sensitive detection, and the square-wave mixer is also referred to as the phase-sensitive detector (PSD) or the synchronous detector.

A separate *AC Volt* mode allows the square-wave mixer to be controlled by the signal polarity of the input signal itself, essentially converting the SR124 into an absolute-value averaging measurement. When a phase reference signal is not available, the AC Volt mode (together with the input filter) can be used to recover specific AC signals as well, although the lock-in mode will almost always produce superior results when a reference is available.

The final measured value is displayed on the jeweled panel meter, and output as a proportional DC voltage. Full-scale sensitivity is set from the front panel in 1 – 2 – 5 steps from 100 nV to 500 mV. A full scale input in-phase with the reference will generate +10 V at the output BNC, while a full scale signal 180° out of phase will generate –10 V. Lock-in amplifiers as a general rule display the input signal in volts RMS, and this is the basis for the SR124 calibration as well. For example, if the SR124 is configured for 2 mV sensitivity and a 1 mV<sub>rms</sub> sine wave is input, at the reference frequency, then the BNC output will read +5 V and the panel meter will show 50% positive deflection.

## 2.2 Instrument overview

An overview of the SR124 with its main sections is given below. Further details of each block are in chapter 3. A block diagram of the SR124 is given in Figure 2.1.

### 2.2.1 Reference section

Operating in Lock-In mode, the SR124 requires the reference oscillator to control the frequency and phase of the square-wave mixer. The analog reference oscillator of the SR124 generates a stable sine wave with outputs at 0°, 90°, 180°, and 270° (all four outputs can be monitored from rear panel BNC connectors). The oscillator is based on an analog voltage-controlled oscillator (VCO) that can tune across a factor of 100 in frequency; 5 overlapping frequency ranges are available for operation from 0.2 Hz – 21 Hz, up to 2 kHz – 210 kHz. The oscillator is controlled in one of three ways: internal, rear-panel VCO, and external reference. When the SR124 operates in AC Volt mode, the reference oscillator is available for excitation outputs, but is not routed to the PSD.

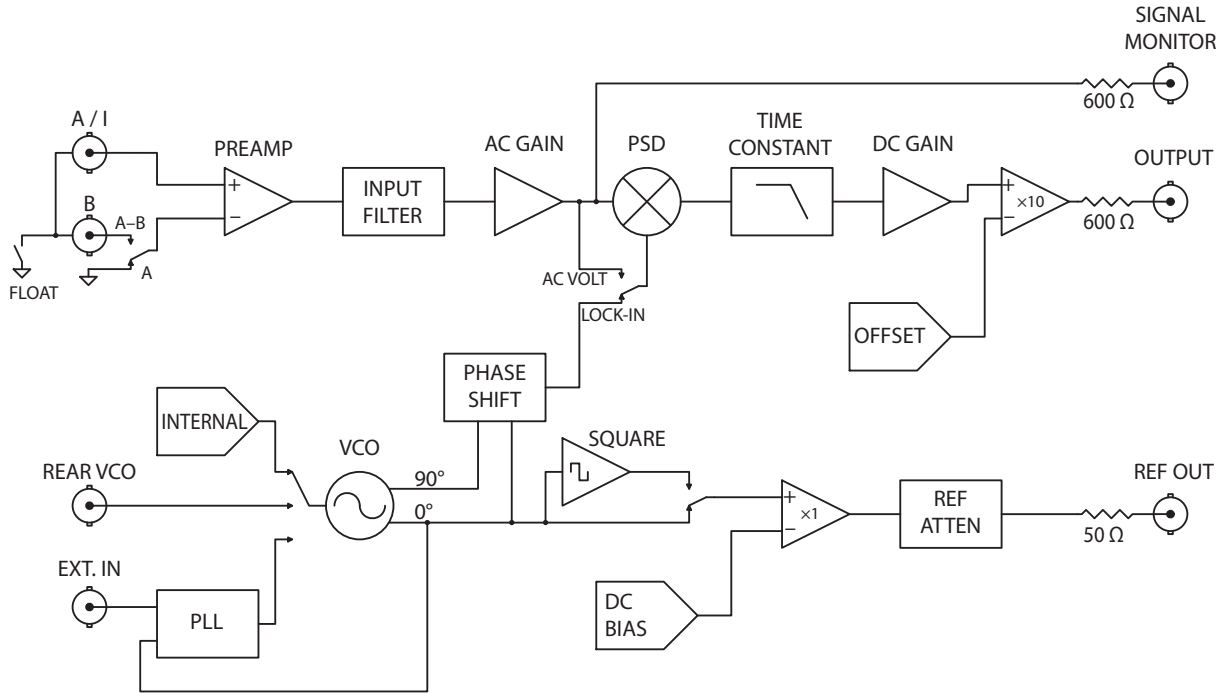

Figure 2.1: The SR124 block diagram.

### 2.2.1.1 Internal mode

Operating in Internal mode, the SR124 oscillator is programmed by an internally-generated DC voltage source. Within the oscillator frequency range (set by the **Range** knob), the oscillator frequency is controlled with the front-panel control knob or remote command.

### 2.2.1.2 Rear-panel VCO mode

When configured for Rear VCO operation, the SR124 oscillator programming voltage is directly controlled by the user through a rear-panel BNC input. Input voltage from 0 to +10 V will set the oscillator frequency between the lower and upper limits set by the range, with an approximately linear transfer function.

### 2.2.1.3 External mode

The SR124 oscillator can lock to an external reference signal applied to the Ext. In BNC connector. This input operates in two distinct modes, sine input and TTL input (indicated by the *TTL* indicator just above the connector).

In sine mode, this input is AC coupled above 0.016 Hz (10 s time constant), and has an (AC) input impedance of 1 M $\Omega$ . A sine wave input greater than 100 mVrms for frequencies above 2 Hz (500 mV below 2 Hz) will trigger the input discriminator. Positive zero crossings are detected and considered to be the zero for the reference phase shift. Note that, because the input is AC coupled, the discriminator circuit actually triggers when the input signal crosses the DC average input value in the positive direction.

When a user has a square wave or other TTL-like signals, the Ext. In should be operated in TTL mode. In this configuration, the input is DC coupled, and the input discriminator triggers on positive edges as they cross +1 V. In TTL mode, there is no restriction on the reference input duty factor, so long as the input pulses are at least 100 ns wide.

Operating in external mode, the user can select between locking to the fundamental of the input frequency, or either of the first two harmonics. Locking to  $2f_{External}$  will cause the reference oscillator to function at twice the external input frequency; locking to  $3f_{External}$  will similarly cause the reference oscillator to operate at three times the external input frequency. Note that, for harmonic operation, the Range setting must correspond to the final frequency for the reference oscillator, which might not include the user's external input frequency.

#### 2.2.1.4 Reference output

The SR124 reference oscillator drives the front-panel Ref. Out BNC signal. This output can be configured as either sine wave or square wave. The amplitude of the reference output can be set from 10 V to 100 nVrms; at several points passive resistive attenuators are switched in to reduce the signal amplitude while keeping a high signal-to-noise ratio on the Ref. Out signal.

The Ref. Out signal can also be DC biased, allowing users to more easily perform experiments such as differential conductance measurements without additional instrumentation. When enabled, the DC Bias is added to the reference oscillator output; the range of DC Bias is dependent on the reference amplitude, as the Bias and AC both are routed through the same resistive attenuators. See section 3.4 for the detailed interdependence of DC Bias and reference amplitude.

The rear panel Reference Output monitors are not shifted by the DC Bias setting, and they are not attenuated by the amplitude setting; these 4 "quadrant" monitors provide 1 V outputs for auxiliary use.

### 2.2.1.5 Phase shift

A commandable phase shift, between  $0^\circ$  and  $360^\circ$ , is applied between the reference oscillator and the phase-sensitive detector. This phase shift determines the phase at which the lock-in will respond. If the Ref. Out signal is directly connected to the Signal Input (A), and the phase is set to  $90^\circ$ , the output will be near zero; setting the phase to  $180^\circ$  will result in a negative output signal.

## 2.2.2 Signal section

The SR124 Signal section provides the amplification and signal conditioning of the analog signal that is applied to the phase sensitive detector. Inputs can be either voltage or current, and single-ended or differential.

### 2.2.2.1 Voltage preamplifier

The SR124 front-end signal input stage consists of a JFET-based low-noise differential voltage preamplifier. Inputs can be configured as either single-ended (A) or differential (A–B). To preserve the low noise performance of the input JFET's, this front-end input stage amplifies the input by a gain of  $50\times$  ( $5\times$  for the largest scale sensitivities).

In single-ended operation, the SR124 internally measures the signal as a voltage on the center pin of the A input, referenced to internal ground in the instrument. This is indicated as *A* on the front panel. In fully differential operation, the preamplifier measures the voltage difference between the center pins of the A and B inputs. This configuration is indicated as *A–B* on the front panel.

When using differential input mode, it is important that both input cables travel the same path between the experiment and the lock-in. Specifically, there should not be a large loop area enclosed by the two cables. Such loops are susceptible to magnetic pickup. Ideally, the two coax cables are equal length and fastened to each other along their length.

When used with an SRS external preamp, such as any model from the SR55x series, the SR124 should always be configured for *A–B* input, and two equal-length BNC cables should be used to connect the preamp output to the lock-in signal input.

### 2.2.2.2 Current preamplifier

The current input on the SR124 uses the A input BNC. Two internal gain settings are available:  $10^6$  Volts/Amp and  $10^8$  Volts/Amp. The current input is always DC coupled and includes an input (burden)

resistor of  $100\ \Omega$  ( $10^6$  range) or  $1\ \text{k}\Omega$  ( $10^8$  range). The maximum full-scale input signal is  $500\ \text{nA}$  ( $10^6$  range) or  $5\ \text{nA}$  ( $10^8$  range). Selecting AC input coupling will block the DC *output* of the current amplifier before it is further amplified by the voltage preamplifier.

Current (transimpedance) amplifiers can be susceptible to noise peaking or oscillation when driven with excessive input capacitance. Cable capacitance in particular should be minimized when using the current amplifier by selecting the shortest cables practical. The SR124 current inputs will remain stable for total input capacitances below  $12\ \text{nF}$ . Note, however, that external input capacitance will increase the voltage noise gain of the current amplifier; input capacitance should always be minimized for best performance.

The overall sensitivity of the SR124 in current mode is dependent on the Sensitivity setting. The current preamplifier itself converts the input current signal to a low-level voltage with the specified transimpedance gain ( $10^6$  or  $10^8$ ); the resulting voltage signal is then amplified by the entire signal chain including the voltage preamplifier. The overall full-scale sensitivity is determined by dividing the Sensitivity setting by the current gain. For example, if the Sensitivity is set to  $20\ \text{mV}$  and the input is configured as  $10^8\ \text{V/A}$ , the full-scale sensitivity will be  $200\ \text{fA}$  ( $20\ \text{mV} / 10^8\ \text{V/A}$ ).

In most cases, there is little noise improvement for current inputs by selecting dynamic reserve of *Low Noise*. The greatest stability is achieved with *High Res*.

### 2.2.2.3 Grounding

To minimize noise pick-up, it is important to ground the outer shield of the input cable(s). Grounding the input cable at *both* ends, however, can in some situations introduce unwanted ground loops to the experiment. This has the potential to allow stray magnetic flux to induce ground currents to flow through the shield, creating additional noise and potentially upsetting sensitive measurements.

To help users better manage grounding, the SR124 provides control of the local grounding of the input BNC shields. When set to *Ground*, the shields on the A and B input connectors are electrically tied to the SR124 ground. When set to *Float*, however, a  $10\ \text{k}\Omega$  resistor is added in series between the connector shells and instrument ground. This  $10\ \text{k}\Omega$  resistor is large enough to block flux-generated ground currents, while still preventing stray charge from accumulating on the connector shell. If the user's signal source already provides a good, low-impedance connection between the signal shield and ground, then selecting *Float* may eliminate potential ground-loop problems.

#### 2.2.2.4 AC versus DC coupling

The signal input can be AC or DC coupled. The AC coupling high pass filter passes signals above 160 mHz and attenuates signals at lower frequencies. Internal gain stages within the signal path are always AC coupled, so any user DC offset will not affect the results at the phase-sensitive detector output (where they would otherwise generate a “ $1 \times f$ ” ripple at the output). However, if the input signal has a significant DC offset relative to the AC amplitude, then AC coupling will significantly improve the overall dynamic reserve by blocking the DC input before it could saturate the preamplifier.

When operating in differential mode (A–B), AC coupling may reduce the SR124’s effective common-mode rejection and gain accuracy, as the blocking capacitors for the AC coupling are only matched to 5% tolerance. This effect is most pronounced at frequencies below 10 kHz.

#### 2.2.2.5 Dynamic reserve

The total signal gain for the SR124 is distributed between the AC signal path ahead of the PSD, and the DC signal path following the PSD. The product of all gains, AC and DC, combine to provide the selected full-scale Sensitivity. How this allocation is made between AC and DC gain determines the dynamic reserve of the lock-in.

Dynamic reserve is traditionally defined as the ratio of the largest interfering signal that can be tolerated, to the full scale input signal, expressed in dB. For example, if the SR124 is operating at full scale sensitivity of  $1 \mu\text{V}$ , and an interfering signal of up to 1 mV can be rejected before overloading, the dynamic reserve is 60 dB.

Many of the noise advantages of a lock-in amplifier come from the improved noise and stability properties of electronics operating at AC frequencies compared to DC. Overall total gain is determined by the full-scale sensitivity, but the relative allocation of that gain between the AC and DC portions of the instrument rely on a “policy” decision that the user can influence using the Reserve setting.

For the lowest noise and greatest output stability, set the Reserve mode to *Low Noise*. This will allocate the maximum gain to the AC portion of the signal path, and apply the minimum DC gain needed for the final sensitivity. This configuration minimizes the impact of offsets and drift from the DC circuitry, but also tends to reduce the dynamic reserve since more of the signal gain is applied to the AC path, before the PSD can act to select the signal of interest.

For the greatest dynamic reserve, set the Reserve mode to *High Res.* This will allocate the maximum gain to the DC portion of the signal

path, and apply the minimum AC gain needed for the final sensitivity. This configuration will have worse offset and drift behavior compared with Low Noise, since the DC gain stages are providing more of the overall total gain. However, larger interfering signals can be tolerated without overloading the AC circuits, and the PSD will then tend to greatly suppress that interference.

Between these two settings, a compromise *Normal* mode is also available, which provides more DC gain than the Low Noise setting, but less than the High Reserve setting.

See section 3.2 for more details about the exact gain allocations and overload limits for these three modes.

### 2.2.3 Input Filter

The phase-sensitive detector is the primary feature for optimizing recovery of small signals in the presence of noise. However, the programmable input filter can be a helpful supplement in optimizing the SR124's performance. In applications with significant noise or other interference, the magnitude of the interfering signals can limit the total amount of AC gain that can be used before the mixer. The input filter is available to suppress those interfering signals, allowing greater AC gain to be used for better low-level signal recovery.

The input filter is located in the AC signal path, between the preamplifier and the programmable AC gain stage. The input filter's function can be selected as Low Pass, High Pass, Band Pass, or Notch filter. The filter can also be bypassed by selecting Flat. The filter is realized as a two-pole state variable circuit, allowing fine control of the filter tuning parameters. The input filter is typically used to either selectively pass a frequency range that spans the input signal, or to selectively reject one or more interfering signals at frequencies removed from the signal; these two approaches are sometimes indistinguishable.

The filter also has a user-configurable "Q" setting, which controls the relative width of the filter's frequency response. In band pass and notch settings, higher Q settings provide a narrower filter response, allowing more selective frequency selection; lower Q settings wider filters, with broader frequency selection. Note that for the low pass and high pass settings, the filter gain is calibrated for unity gain at the peak response—the response across the pass band far from the peak response attenuates the signal by a factor of  $1/Q$ . See section 3.3 for the detailed filter transfer functions of the SR124 input filter.

## 2.2.4 Output

The DC portion of the SR124, beginning with the output of the phase-sensitive detector, is collectively referred to as the output section.

### 2.2.4.1 Output filter

The output of the phase sensitive detector contains many signals. Most of the output signals are at the sum or difference frequency between an input signal frequency and the reference frequency. Only the component of the input signal whose frequency is exactly equal to the reference frequency will result in a DC output. To remove all the unwanted AC signals, both the “ $2 \times f$ ” (sum of the signal and reference) as well as the noise components, a configurable low-pass filter is used.

The output low pass filter follows the mixer, and comes before the final output DC gain is applied. This filter is key to the performance of the lock-in amplifier, as it selects the DC output of the mixer while rejecting the high frequency ripple artifacts naturally generated by the mixing process. The filter can be configured as either 1 pole or 2 poles, with a time constant between 1 ms and 300 s settable in 1–3–10 steps.

The time constant is related to the  $-3$  dB frequency of the filter by the relation  $f_{-3\text{dB}} = 1/(2\pi\text{TC})$ , where TC is the time constant in seconds. The low pass filters are simple 6 dB/octave roll off, RC-type filters. A 1 second time constant refers to a filter whose  $-3$  dB point occurs at 0.16 Hz. In the SR124 the user can select one or two successive stages of output filter, so that the overall filter can roll off is either 6 dB or 12 dB per octave. The time constant refers to the  $-3$  dB point of each filter stage alone (and not the combined filter).

The time constant also determines the equivalent noise bandwidth (ENBW) for the measurement. The ENBW is not the filter  $-3$  dB bandwidth; rather it is the effective bandwidth for Gaussian distributed white noise. When set to 6 dB/octave, the ENBW is  $1/(4 \times \text{TC})$ ; when set to 12 dB/octave,  $\text{ENBW} = 1/(8 \times \text{TC})$ .

It can be useful to consider the frequency domain, in which the output filter defines the width of the passband for detection at the reference frequency. By mixing with the lock-in amplifier, this AC band is mixed down to DC for final output. The  $-3$  dB bandwidth for signal selection at the input is simply  $1/(2\pi \times \text{TC})$ . To effectively reject the mixer AC artifacts, the output filter should be set so that  $\text{TC} > (2 - 10) \times (1/f)$ , where  $f$  is the reference oscillator frequency.



## 2.2.4.2 AC Volt mode

When phase-sensitive detection is not possible, the SR124 can be configured for AC Volt mode. In this setting, the reference oscillator is unused and the phase-sensitive detector (square wave mixer) is controlled directly by the polarity of the amplified AC input signal. The instrument now acts as an averaging AC voltmeter, where the detection element is an absolute value detector.

For most applications using AC Volt mode, the Reserve setting should be set to Low Noise, since there is no reserve benefit from the mixer in this configuration. If the input signal is not already relatively clean with high signal-to-noise, the input filter may be used to define the frequency band for measurement.

## 2.3 Navigating the front panel

The front panel of the SR124 is organized into distinct functional sections. Knowing this organization will help you to become familiar with its operation. A diagram of the entire front panel is in Figure 2.2, below.

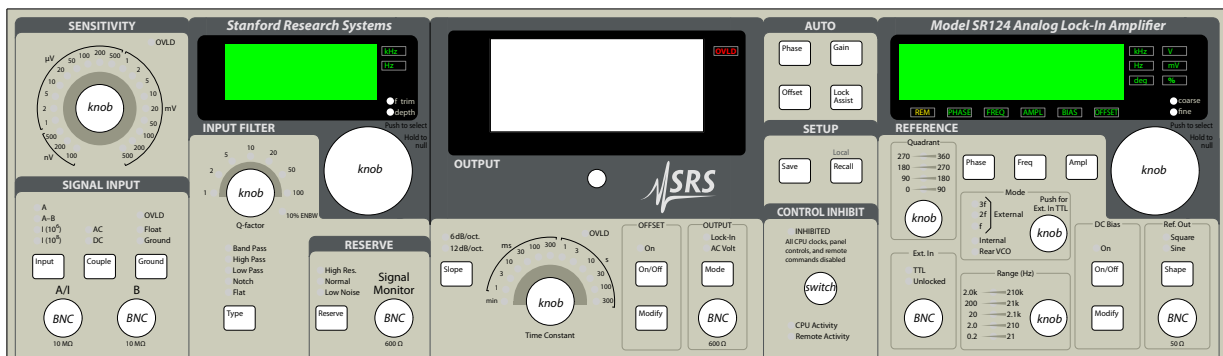

Figure 2.2: The SR124 front panel.

In Figure 2.2, the two large rectangular blocks above “INPUT FILTER” and “REFERENCE” are static numeric displays. The larger white rectangle in the upper center of the drawing is the jewel-bearing analog panel meter.

The two large knobs each have a push-button secondary function; in addition to adjusting the parameter currently “in focus” (more about that later), briefly pressing the knob inward has a secondary function. Also, holding the knob in for several seconds has a tertiary function—clearing or nulling the parameter in focus.

Near the center of the instrument, in the “CONTROL INHIBIT” block, is a large locking toggle switch. When in the upper position, none of the front-panel (or remote) interface functions are operable. The analog signal processing of the SR124 remains fully functioning while the Inhibit switch is up, but no controls will respond. For normal operation, the Inhibit switch should be left in the lower position.

Where applicable, the corresponding remote command is listed, along with the page where it is defined, in parentheses, like this: (FORM, 4 – 11 ).

### 2.3.1 Signal input section

The left-hand section of the instrument comprises the “Signal Input”. See Figure 2.3 for detail.

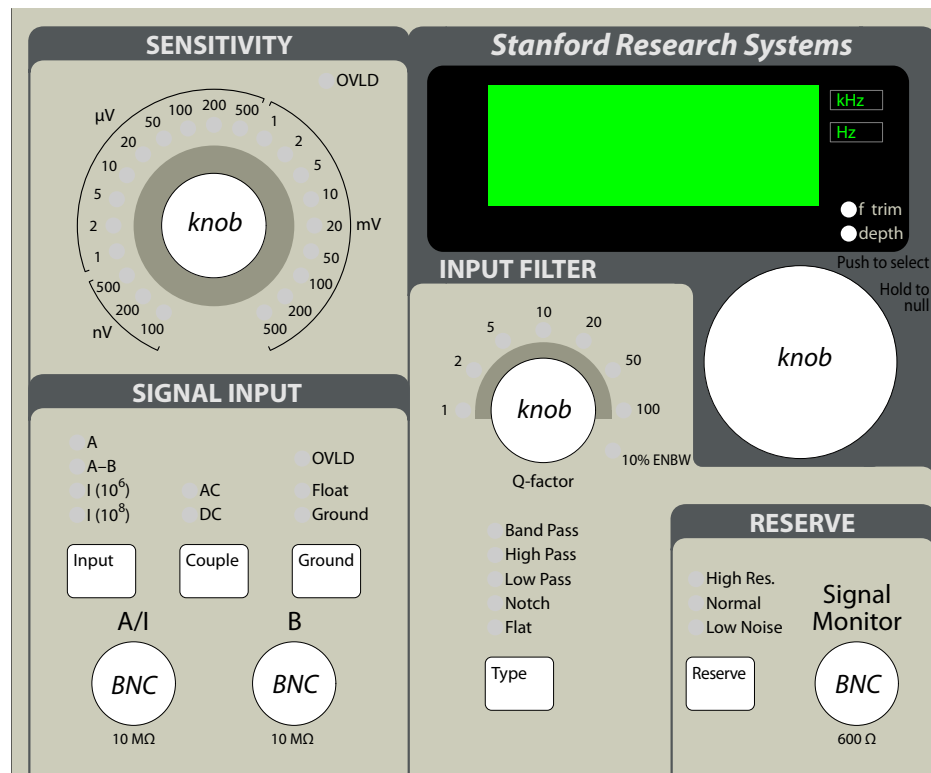

Figure 2.3: The SR124 front panel signal input section.

#### 2.3.1.1 Signal input

User input signals are applied to the SR124 through the “A/I”, or the “A/I” and “B” BNC connectors. The input configuration is controlled

by the [Input] button. Each successive press of [Input] steps from *A*, to *A-B*, to  $I(10^6)$ , to  $I(10^8)$ , and then back to *A*. (ISRC, 4 – 11 )

Input coupling can be switched between AC and DC by pressing [Couple]. (ICPL, 4 – 12 )

The outer (shield) terminal of both input BNCs are tied to each other and can be set to *Float* (through 10 k $\Omega$ ) or *Ground* (through 10  $\Omega$ ) by pressing [Ground]. (IGND, 4 – 12 )

Overloads at the preamplifier stage are indicated by the red *OVLD* indicator in the signal input block.

### 2.3.1.2 Sensitivity

The overall gain of the SR124 is controlled by setting the sensitivity. Full scale sensitivities from 100 nV to 500 mV, in 1–2–5 steps, can be selected by turning the **SENSITIVITY** knob. (SENS, 4 – 13 )

Overloads in the AC signal path, after the preamplifier but before the phase sensitive detector, are indicated by the red *OVLD* indicator in the sensitivity block.

### 2.3.1.3 Input filter

The input filter type is selected by pressing [Type]; selections cycle from *Band Pass*, *High Pass*, *Low Pass*, *Notch*, and *Flat*. (TYPF, 4 – 12 )

The filter Q-factor can be adjusted between 1 and 100 by turning the **Q-factor** knob. (QFCT, 4 – 12 )

The tuning frequency of the filter is adjusted by turning the large **INPUT FILTER** knob. This knob responds with velocity sensitivity, so turning the knob more quickly will span larger frequency ranges quickly. The frequency setting is displayed on the numeric display, with either *Hz* or *kHz* illuminated. (IFFR, 4 – 12 )

When operating the input filter as *Band Pass* or *Notch* type, and at high Q-factor, it is often necessary to trim the input filter performance. Pressing **INPUT FILTER** cycles the knob's focus between the main frequency tune, a (dimensionless) trim offset of the frequency (*f trim*), and a notch depth adjust (*depth*). When adjusting *f trim* or *depth*, the units annunciators (*Hz* and *kHz*) are both off. (IFTR, 4 – 12 )

### 2.3.1.4 Equivalent Noise Bandwidth

For Gaussian noise, the equivalent noise bandwidth (ENBW) of a filter is the bandwidth of an ideal rectangular filter which passes the

same amount of noise as the real filter in question. For the SR124 input filter operating in band pass mode, with the filter frequency set to  $f_0$  and Q-factor set to  $Q$ , the ENBW is given by

$$\text{ENBW} = \frac{\pi}{2} \times \frac{f_0}{Q}$$

Note that when operating in AC Volt mode, the output is an absolute-value average, and not a true RMS amplitude. The SR124 gain calibration is set to correct for this when measuring sinusoidal inputs (see section 3.1.2 for more detail). When measuring noise with the SR124, this calibration leads to the output being  $\sqrt{(\pi/2)}$  times the actual RMS Gaussian noise value.

To correct for this, the 10%-ENBW setting actually programs the Q-factor to 12.34. When this value is substituted into the ENBW formula above, *and* the  $\sqrt{(\pi/2)}$  correction is applied, the resulting output in AC Volt mode with band pass filtering provides an equivalent noise bandwidth of 10% the filter center frequency. Note again that in AC Volt mode, the SR124 should be operated in Low Noise reserve mode.

### 2.3.1.5 10%-ENBW

The SR124 has an additional setting available for the Input Filter Q-factor to set the Equivalent Noise Bandwidth to 10% (10% ENBW). In this configuration, the equivalent noise bandwidth for Bandpass mode is 10% of the filter center frequency: for example, if the input filter is set to 5.00 kHz, then 10%-ENBW mode provides 500 Hz equivalent noise bandwidth through the input filter.

To set the SR124 Q-factor to 10%-ENBW, turn the Q-factor knob clockwise, one “click” past the Q=100 setting. For units with firmware revision 3.0 and later, the 10% ENBW indicator will illuminate. On older units with firmware revision 2.40 through 2.90, the numeric displays will briefly show the pattern “Enb 10pct” to indicate 10%-ENBW. On these older units, when configured for 10%-ENBW, none of the Q-factor indicators will be illuminated.

The remote command QFCT (4 – 12 ) sets the 10%-ENBW mode.

### 2.3.1.6 Reserve

The dynamic reserve setting of the SR124 can be cycled between *High Res.*, *Normal*, and *Low Noise* by successive presses of [Reserve]. (RMOD, 4 – 13 )

The output of the entire AC signal chain, just prior to the phase sensitive detector, can be monitored from the “Signal Monitor” BNC.

### 2.3.2 Output section

The next section of the instrument is “Output”. See Figure 2.4 for detail.

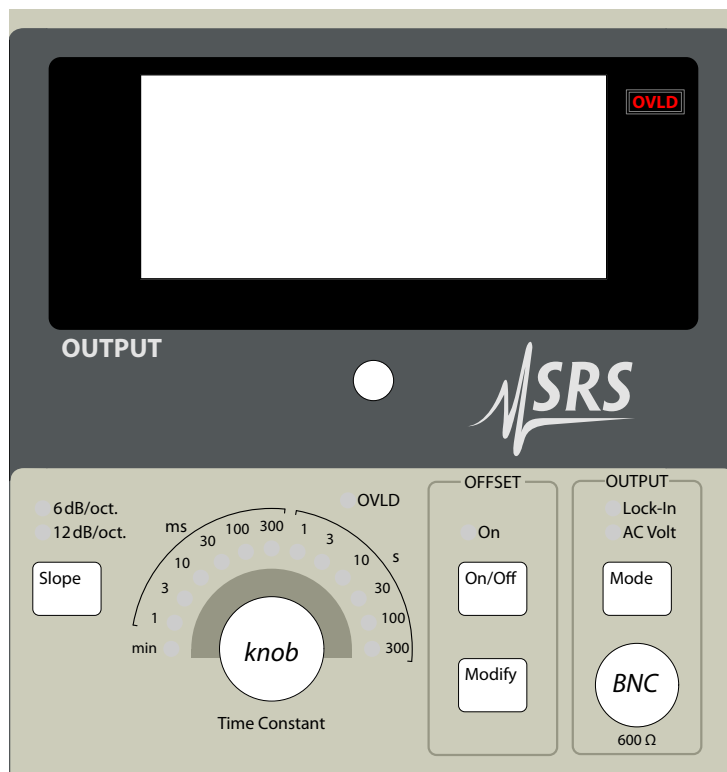

Figure 2.4: The SR124 front panel output section.

The panel meter shows the output signal from the SR124. This is the same signal as appears at the output BNC. The meter shows +100% deflection when the BNC output is +10 V, and –100% deflection when the BNC output is –10 V.

If any part of the signal path is overloaded, the master *OVL'D* annunciator, at the upper right of the panel meter, is lit.

#### 2.3.2.1 Time constant

The output filter time constant is set with the Time Constant knob. (OFLT, 4 – 14 )

The choice of one or two poles of output filter is toggled by pressing [Slope]. (OFSL, 4 – 14 )

If the DC output signal is overloaded, the red *OVL*D indicator (just above the time constant control) is lit.

### 2.3.2.2 Offset

The output offset function is enabled and disabled by pressing the [On/Off] button within the OFFSET block. (OFSE, 4 – 14 )

Pressing [Modify] within the OFFSET block switches the focus of the REFERENCE block to the offset value; turning the REFERENCE knob will then adjust the offset between –1000% and +1000% of full scale. (OFST, 4 – 15 )

### 2.3.2.3 Output

The overall functional mode of the SR124 is controlled by the [Mode] button within the OUTPUT block. Pressing [Mode] toggles between *Lock-In* and *AC Volt* modes. (OMOD, 4 – 14 )

The output signal from the SR124 is available on the BNC output connector within the OUTPUT block. Full scale at the output is  $\pm 10$  V.

## 2.3.3 Setup section

The next section of the instrument is “Setup”. See Figure 2.5 for detail.

### 2.3.3.1 Automatic functions

Four built-in automatic functions are available in this block.

Pressing [Phase] within AUTO starts an auto-phase cycle, which adjusts the oscillator phase to maximize the output signal. Auto-phase is disabled when output offset is enabled. (APHS, 4 – 16 )

Pressing [Gain] starts an auto-gain cycle, which will increase the gain (decrease the sensitivity) step by step to maximize the output without causing a signal overload. (AGAN, 4 – 16 )

Pressing [Offset] starts an auto-offset cycle, which will adjust the OFFSET setting to null the output signal. Note that the auto-offset cycle does not change the enabled/disabled state for OFFSET. Running auto-offset with offset disabled will set and report the offset parameter that would null the output if offset were enabled, but the output is unaffected. (AOFF, 4 – 16 )

Pressing [Lock Assist] starts a measurement cycle for the Reference oscillator Ext. In, to speed the locking to a user’s reference when operating in external mode. (ASST, 4 – 17 )

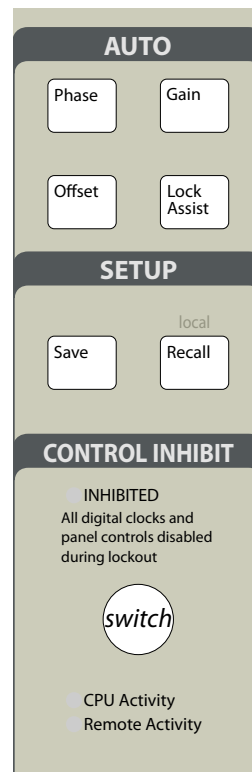

Figure 2.5: The SR124 front panel setup.

### 2.3.3.2 Setup

A total of nine (9) separate user configurations can be saved in the SR124. Pressing [Save] shifts the focus to saving; the **REFERENCE** knob now scrolls between 0-8 to select one of the nine user slots. Pressing [Save] a second time saves the current instrument configuration into that slot; pressing any other key abandons the save request. (SSET, 4 – 15 )

The [Recall] key is used to restore a previously saved configuration. Press [Recall] once to bring up the recall focus, and then turn **REFERENCE** to select between user setting 0 through 8. An additional configuration, the factory defaults, can be restored by turning **REFERENCE** to display “dEFLt”. When the desired settings slot is displayed, press [Recall] again to restore those settings. Pressing any other key will abandon the recall request. (RSET, 4 – 15 )

When the SR124 is in *REM* mode (remote control), pressing the [Recall] button asserts the “Local” function and returns the instrument to local mode. (LOCL, 4 – 19 )

### 2.3.3.3 Control inhibit

The SR124 user interface controls can be inhibited by setting the control inhibit switch to the upper position. Note that this is a locking toggle switch, and must be gently pulled outwards while switching upwards or downwards.

When in the upper position, the *INHIBITED* indicator is illuminated to alert the user that controls and remote commanding are all inhibited.

### 2.3.4 Reference section

The next section of the instrument is “Reference”. See Figure 2.6 for detail.

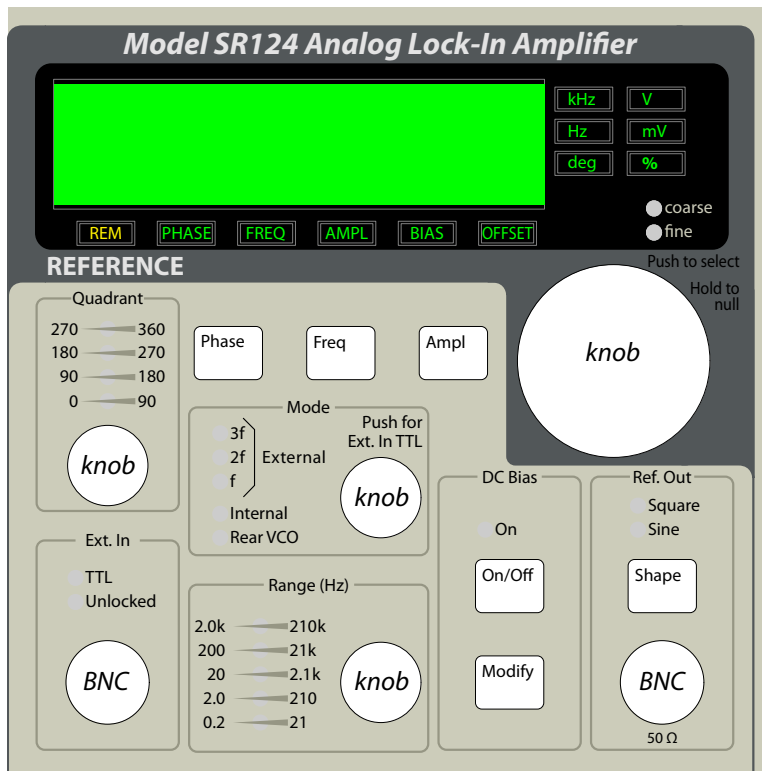

Figure 2.6: The SR124 front panel reference.

The numeric display for the Reference section can show the settings for phase, reference oscillator frequency, amplitude, DC bias, output offset, and also the save/recall slot. This selection is generally called the “focus” of the interface, and is indicated by one of the text annunciators at the bottom of the numeric display. For most



of the parameters, turning the large **REFERENCE** knob allows that parameter to be adjusted.

Pressing the **REFERENCE** knob inward toggles between *coarse* and *fine* scrolling speeds for adjusting parameters. Holding the knob in for approximately 2 seconds will cause the parameter to be nulled (other than frequency and amplitude, which do not allow zero settings).

Within the REFERENCE section, pressing [Phase] brings the reference phase shift into focus. Note that in AC Volt mode, phase is unused (but may still be adjusted). (PHAS, 4 – 9)

Pressing [Freq] brings frequency into focus. When operating in *Internal* mode, frequency can be adjusted across the 2 decades range selected by the Range block. (FREQ, 4 – 9)

Pressing [Freq] when operating either in *Rear VCO* mode or one of the External modes causes the SR124 to perform a frequency measurement on the actual reference oscillator frequency. That frequency is then displayed on the numeric display.

If the focus is already on *FREQ* when the instrument changes mode into either *Rear VCO* or External, the display will show “- - - -”; pressing [Freq] again will cause a frequency measurement to be performed and displayed. Each successive press of [Freq] initiates a new measurement.

Pressing [Ampl] brings the reference output amplitude into focus. Turning **REFERENCE** adjusts the output amplitude (in Vrms). (SLVL, 4 – 10)

#### 2.3.4.1 Quadrant

Turning the **Quadrant** knob adds or subtracts 90° from the current value of the reference phase shift. One of the four quadrant indicators is always illuminated to show which quadrant the current value of phase lies in. (QUAD, 4 – 9)

#### 2.3.4.2 Ext. In

The Ext. In BNC input is used for locking the SR124 to an external reference; this input is unused when in *Internal* or *Rear VCO* mode. The Ext. In circuit can be configured for either sine inputs or TTL inputs; when in TTL mode, the *TTL* indicator is illuminated in this section. The user can toggle between sine and TTL mode by pressing the **Mode** knob (see below).

### 2.3.4.3 Mode

The **Mode** knob selects the reference oscillator mode. Possible selections are *Rear VCO*, *Internal*, *f External*, *2f External*, and *3f External*. (FMOD, 4 – 9)

The **Mode** knob also controls the Ext. In configuration between sine and TTL modes. Pressing **Mode** inwards toggles between the two states, as indicated by the *TTL* indicator in the Ext. In sub-section. (RSLP, 4 – 10)

### 2.3.4.4 Range

The **Range** knob selects the reference oscillator frequency range. Ranges each span 2 decades, and overlap by one decade each. (FRNG, 4 – 10)

### 2.3.4.5 DC Bias

Pressing the [On/Off] button in the DC Bias block toggles the bias on and off for the reference output signal. (BION, 4 – 11)

Depending on the current value of the reference amplitude and bias, the bias might not be allowed to turn on. Full details of the interdependence of DC Bias and amplitude can be found in section 3.4.

Pressing the [Modify] button within DC Bias brings the display focus to *BIAS*. The bias setting can be adjusted by turning **REFERENCE**; however, the bias will not be added to the reference output unless it is enabled with the [On/Off] button. (BIAS, 4 – 11)

### 2.3.4.6 Ref. Out

The Ref. Out BNC connector provides the reference output signal. The RMS amplitude of the signal is adjusted with the *AMPL* parameter. Pressing [Shape] toggles between sine output and square output. (FORM, 4 – 11)

---

## 3 Performance Details

---

This chapter provides a detailed discussion of the operating characteristics and architecture of the SR124.

### In This Chapter

<b>3.1</b>	<b>Sensitivity and gain</b>	<b>3-2</b>
3.1.1	AC Gain	3-2
3.1.2	Scale normalization	3-3
3.1.3	DC gain	3-4
<b>3.2</b>	<b>Dynamic reserve and overloads</b>	<b>3-4</b>
<b>3.3</b>	<b>Input filter details</b>	<b>3-6</b>
<b>3.4</b>	<b>Attenuators and DC bias constraints</b>	<b>3-9</b>
<b>3.5</b>	<b>Automatic functions</b>	<b>3-9</b>
3.5.1	Auto-phase	3-9
3.5.2	Auto-gain	3-10
3.5.3	Auto-offset	3-10
3.5.4	Lock assist	3-10

### 3.1 Sensitivity and gain

While not necessary to operate the SR124, many users will still find detailed information about gain allocation helpful for optimizing measurements.

#### 3.1.1 AC Gain

Table 3.1: AC gain allocation

High Res.	Sensitivity		Pre-gain	Post-gain	Mixer gain	Sig. Mon. gain	Total AC gain
	Normal	Low Noise					
		100 nV	500	100	10	$5 \times 10^4$	$5 \times 10^5$
		200 nV	500	50	10	$2.5 \times 10^4$	$2.5 \times 10^5$
		500 nV	500	20	10	$1.0 \times 10^4$	$1.0 \times 10^5$
	100 nV	1 $\mu$ V	500	100	10	$5 \times 10^4$	$5 \times 10^5$
	200 nV	2 $\mu$ V	500	50	10	$2.5 \times 10^4$	$2.5 \times 10^5$
	500 nV	5 $\mu$ V	500	20	10	$1.0 \times 10^4$	$1.0 \times 10^5$
100 nV	1 $\mu$ V	10 $\mu$ V	500	10	10	$5 \times 10^3$	$5 \times 10^4$
200 nV	2 $\mu$ V	20 $\mu$ V	500	5	10	$2.5 \times 10^3$	$2.5 \times 10^4$
500 nV	5 $\mu$ V	50 $\mu$ V	500	2	10	$1 \times 10^3$	$1 \times 10^4$
1 $\mu$ V	10 $\mu$ V	100 $\mu$ V	500	1	10	$5 \times 10^2$	$5 \times 10^3$
2 $\mu$ V	20 $\mu$ V	200 $\mu$ V	500	0.5	10	$2.5 \times 10^2$	$2.5 \times 10^3$
5 $\mu$ V	50 $\mu$ V	500 $\mu$ V	500	0.2	10	$1 \times 10^2$	$1 \times 10^3$
10 $\mu$ V	100 $\mu$ V	1 mV	500	1	1	$5 \times 10^2$	$5 \times 10^2$
20 $\mu$ V	200 $\mu$ V	2 mV	500	0.5	1	$2.5 \times 10^2$	$2.5 \times 10^2$
50 $\mu$ V	500 $\mu$ V	5 mV	500	0.2	1	$1 \times 10^2$	$1 \times 10^2$
100 $\mu$ V	1 mV	10 mV	50	1	1	$5 \times 10^1$	$5 \times 10^1$
200 $\mu$ V	2 mV	20 mV	50	0.5	1	$2.5 \times 10^1$	$2.5 \times 10^1$
500 $\mu$ V	5 mV	50 mV	50	0.2	1	$1 \times 10^1$	$1 \times 10^1$
1 mV	10 mV	100 mV	5	1	1	5	5
2 mV	20 mV	200 mV	5	0.5	1	2.5	2.5
5 mV	50 mV	500 mV	5	0.2	1	1	1
10 mV	100 mV		5	1	1	5	5
20 mV	200 mV		5	0.5	1	2.5	2.5
50 mV	500 mV		5	0.2	1	1	1
100 mV			5	1	1	5	5
200 mV			5	0.5	1	2.5	2.5
500 mV			5	0.2	1	1	1

Programmable gain stages are located throughout the SR124, in both the AC and DC signal paths. While the actual gain elements can be

found in the detailed schematics, it is useful to group the gain stages into several blocks:

- Pre-gain : The AC gain preceding the tunable input filter.
- Post-gain : The AC gain following the tunable input filter.
- Mixer gain : The AC gain applied at the input to the phase sensitive detector.
- DC gain : The DC gain applied following the mixer, and following the output low-pass filter.

The front panel “Signal Monitor” BNC (located in the Reserve block) provides a buffered copy of the signal after it is amplified by the Pre-gain and Post-gain. The total AC gain, for all sensitivities and reserve settings, is given in Table 3.1.

The nominal overall gain, AC and DC combined, can be calculate from the equation

$$\text{Nominal Gain} = \frac{10 \text{ V}}{V_{\text{FS}}} \quad (3.1)$$

where  $V_{\text{FS}}$  is the full-scale sensitivity, in volts. For example, if the sensitivity is set to  $200 \mu\text{V}$ , the nominal overall gain is  $(10 \text{ V})/(200 \mu\text{V})=50,000$ .

### 3.1.2 Scale normalization

The SR124 is calibrated for RMS units, but the square wave demodulator actually measures an absolute value average. As a result, there can be confusion about the precise values of gain used in the instrument.

On a properly calibrated unit, the SR124 will output exactly 10.00 V when the input is  $V_{\text{FS}}$ , a full-scale (RMS) **sine** wave, properly phased with the oscillator.

The input function  $V(t)$  for a full-scale sine wave is

$$V(t) = \sqrt{2}V_{\text{FS}} \sin(2\pi ft + \phi)$$

When properly phased for maximum signal, the PSD multiplies by the square-wave function

$$\text{PSD}(t) = \begin{cases} +1 & : 0 \leq (2\pi ft + \phi) \bmod 2\pi < \pi \\ -1 & : \pi \leq (2\pi ft + \phi) \bmod 2\pi < 2\pi \end{cases}$$

The time-averaged value of the product  $V(t) \times \text{PSD}(t)$  can be evaluated by integrating the first half-cycle of the input sine wave

$$\frac{1}{\pi} \int_0^{\pi} \sqrt{2}V_{\text{FS}} \sin(\theta) d\theta = \frac{2\sqrt{2}}{\pi} V_{\text{FS}}$$

The factor,  $2\sqrt{2}/\pi = 0.9003$ , would cause the SR124 to read about 10% too low if the circuitry were tuned to provide a total gain as given by Equation (3.1). Instead, the actual total gain is set about 11% greater, to correct for this factor.

The correct formula for the actual overall gain is

$$\text{Actual Gain} = \frac{10 \text{ V}}{V_{\text{FS}}} \times \frac{\pi}{2\sqrt{2}} \quad (3.2)$$

Continuing the example from above, for a sensitivity of  $200 \mu\text{V}$ , the actual overall gain, given by Equation (3.2), is 55,536.

A natural consequence of this calibration is that, when the input waveform is a **square** wave, the output reads approximately 11% greater than the actual RMS value of the (square wave) input.

### 3.1.3 DC gain

The DC gain is programmed by the SR124 to make up the difference between the total AC gain and the required Overall Gain from Equation (3.2). Continuing the example above, with full-scale sensitivity of  $200 \mu\text{V}$ , we can see from Table 3.1 three possible AC gain configurations, based on the dynamic reserve setting. At *Low Noise*, the total AC gain is  $2.5 \times 10^3$ ; for *Normal* reserve, the total AC gain is 250; while at *High Res.*, we see the total AC gain is 25. Since in each case, the overall Actual Gain must be 55,536, we find the DC gain is:

Reserve	DC Gain
<i>Low Noise</i>	22.21
<i>Normal</i>	222.1
<i>High Res.</i>	2221

These three DC Gains are used for most of the sensitivity settings of the SR124. The exceptions are at the extreme values of sensitivity, and are as follows:

Low Noise : DC Gain is 222.1 for sensitivities 100 nV, 200 nV, and 500 nV.

Normal : DC gain is 22.21 for sensitivities 100 mV, 200 mV, and 500 mV.

High Res. : DC gain is 222.1 for sensitivities 10 mV, 20 mV, 50 mV; and DC gain is 22.21 for sensitivities 100 mV, 200 mV, and 500 mV.

## 3.2 Dynamic reserve and overloads

The SR124 provides significant flexibility to recover small signals in the presence of noise and other interference: besides overall sensitivity control, the input filter and dynamic reserve settings can both

Table 3.2: Maximum input signals before Input Filter overload

High Res.	Sensitivity		Maximum input (RMS)
	Normal	Low Noise	
		100 nV	14.5 mV
		200 nV	14.5 mV
		500 nV	14.5 mV
	100 nV	1 $\mu$ V	14.5 mV
	200 nV	2 $\mu$ V	14.5 mV
	500 nV	5 $\mu$ V	14.5 mV
100 nV	1 $\mu$ V	10 $\mu$ V	14.5 mV
200 nV	2 $\mu$ V	20 $\mu$ V	14.5 mV
500 nV	5 $\mu$ V	50 $\mu$ V	14.5 mV
1 $\mu$ V	10 $\mu$ V	100 $\mu$ V	14.5 mV
2 $\mu$ V	20 $\mu$ V	200 $\mu$ V	14.5 mV
5 $\mu$ V	50 $\mu$ V	500 $\mu$ V	14.5 mV
10 $\mu$ V	100 $\mu$ V	1 mV	14.5 mV
20 $\mu$ V	200 $\mu$ V	2 mV	14.5 mV
50 $\mu$ V	500 $\mu$ V	5 mV	14.5 mV
100 $\mu$ V	1 mV	10 mV	145 mV
200 $\mu$ V	2 mV	20 mV	145 mV
500 $\mu$ V	5 mV	50 mV	145 mV
1 mV	10 mV	100 mV	1.28 V
2 mV	20 mV	200 mV	1.28 V
5 mV	50 mV	500 mV	1.28 V
10 mV	100 mV		1.28 V
20 mV	200 mV		1.28 V
50 mV	500 mV		1.28 V
100 mV			1.28 V
200 mV			1.28 V
500 mV			1.28 V

be used to optimize out of band rejection. However, to recover the signal of interest, no stage in the signal path can be permitted to overload.

Table 3.2 gives the maximum sinewave input (in  $V_{rms}$ ) that can be applied to the signal input without overloading the pre-gain signal chain, which precedes the input filter. For signals passed by the input filter (all signals, when in *Flat* filter type), Table 3.3 gives the maximum sinewave inputs that can be applied to the signal input without overloading any part of the AC signal path including the PSD (mixer).

Table 3.3: Maximum input signals before PSD overload

High Res.	Sensitivity		Maximum input (RMS)
	Normal	Low Noise	
		100 nV	7 $\mu$ V
		200 nV	24 $\mu$ V
		500 nV	63 $\mu$ V
	100 nV	1 $\mu$ V	7 $\mu$ V
	200 nV	2 $\mu$ V	24 $\mu$ V
	500 nV	5 $\mu$ V	63 $\mu$ V
100 nV	1 $\mu$ V	10 $\mu$ V	130 $\mu$ V
200 nV	2 $\mu$ V	20 $\mu$ V	250 $\mu$ V
500 nV	5 $\mu$ V	50 $\mu$ V	650 $\mu$ V
1 $\mu$ V	10 $\mu$ V	100 $\mu$ V	1.3 mV
2 $\mu$ V	20 $\mu$ V	200 $\mu$ V	2.5 mV
5 $\mu$ V	50 $\mu$ V	500 $\mu$ V	6.5 mV
10 $\mu$ V	100 $\mu$ V	1 mV	12.5 mV
20 $\mu$ V	200 $\mu$ V	2 mV	14 mV
50 $\mu$ V	500 $\mu$ V	5 mV	14 mV
100 $\mu$ V	1 mV	10 mV	129 mV
200 $\mu$ V	2 mV	20 mV	160 mV
500 $\mu$ V	5 mV	50 mV	160 mV
1 mV	10 mV	100 mV	1.25 V
2 mV	20 mV	200 mV	1.25 V
5 mV	50 mV	500 mV	1.25 V
10 mV	100 mV		1.25 V
20 mV	200 mV		1.25 V
50 mV	500 mV		1.25 V
100 mV			1.25 V
200 mV			1.25 V
500 mV			1.25 V

### 3.3 Input filter details

The input filter is constructed as a state-variable filter with user-settable cutoff frequency  $f_0$  and Q-factor. In the SR124, the peak gain of the input filter is calibrated to be unity. The nominal transfer functions are shown in the following figures.

Of particular note is that the pass-band portion of the low pass and high pass filters have a gain of  $1/Q$  far from the resonance. For most applications requiring low pass or high pass input filtering, it is effective to leave  $Q=1$ .



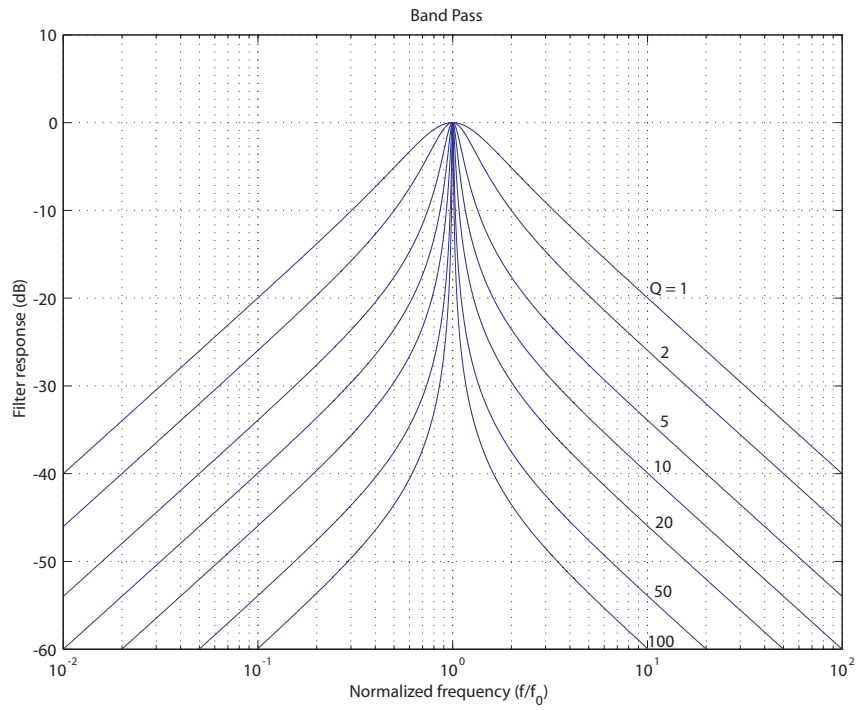

Figure 3.1: The SR124 band pass input filter gain

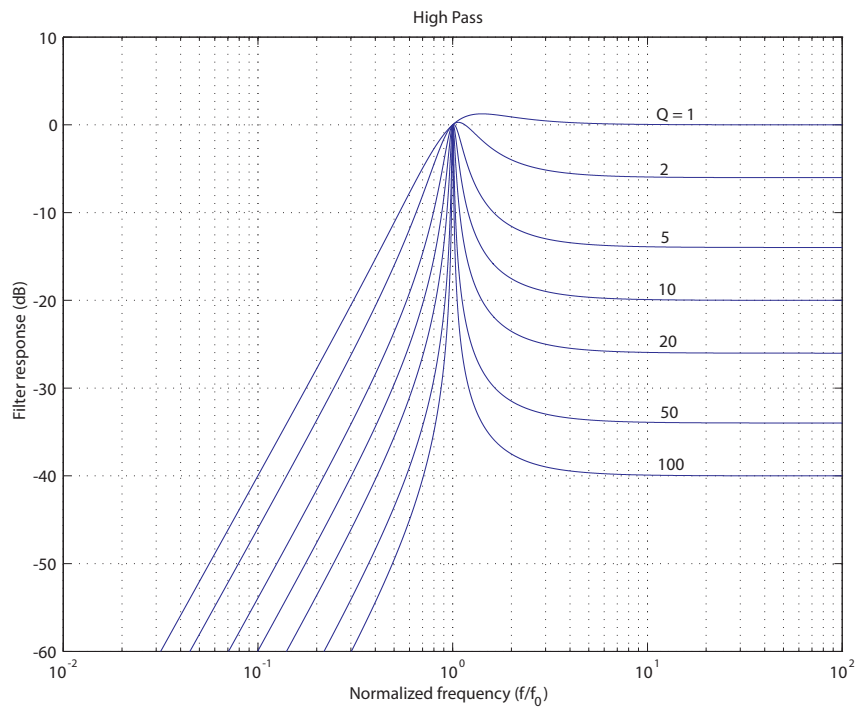

Figure 3.2: The SR124 high pass input filter gain

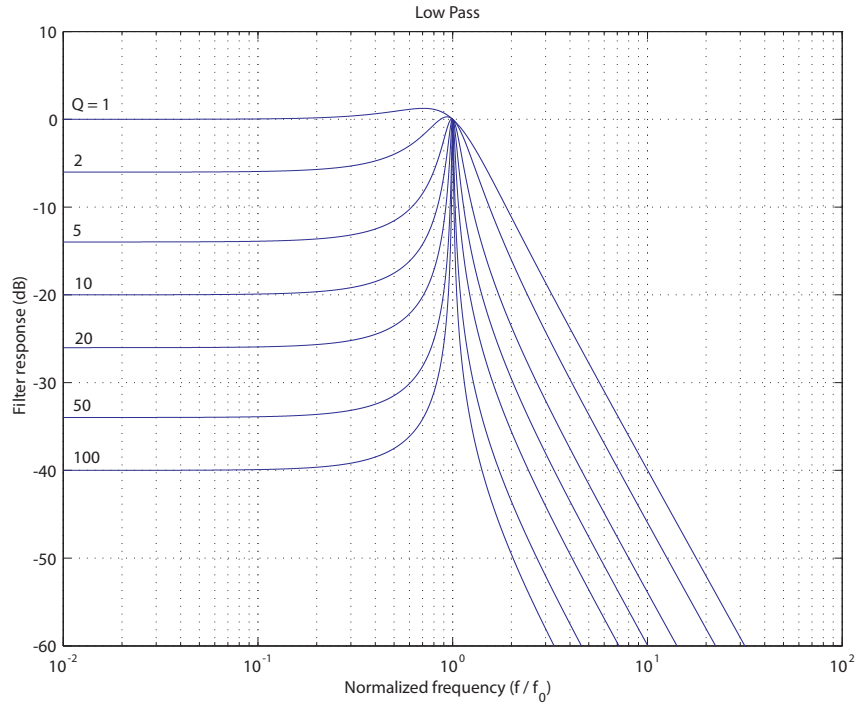

Figure 3.3: The SR124 low pass input filter gain

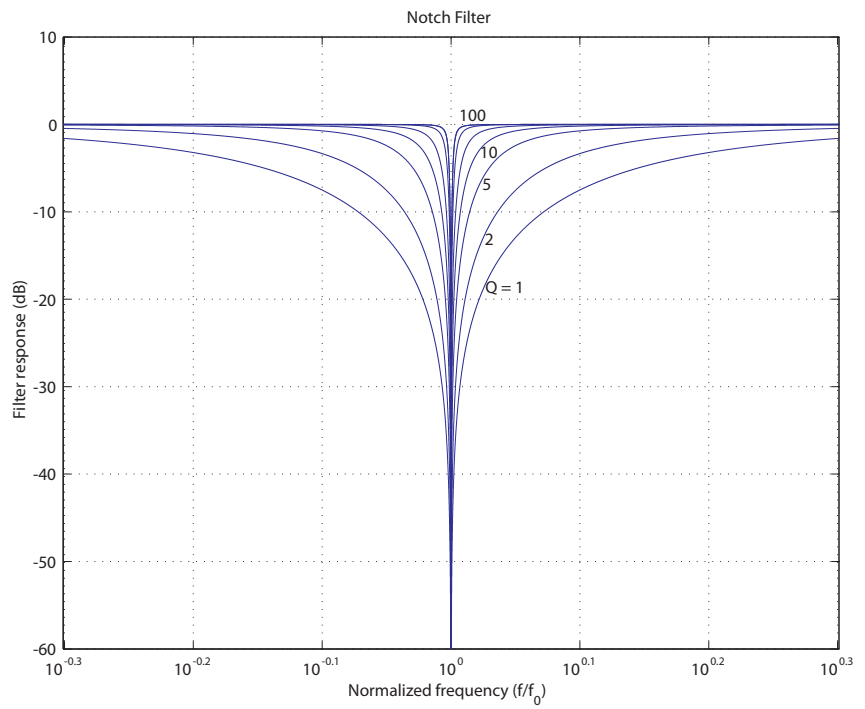

Figure 3.4: The SR124 notch input filter gain

### 3.4 Attenuators and DC bias constraints

The SR124 Reference Output includes several resistive output attenuators to provide low excitations for sensitive experiments. The architecture imposes constraints on the magnitude of DC bias available, depending on the current reference amplitude setting. This constraint is because the DC bias signal is passed through the same resistive attenuator network as the AC reference signal.

Table 3.4 shows the four attenuator ranges, set by the reference output amplitude. Note that any time one of the attenuators is switched in or out (when the amplitude is commanded across one of the boundaries listed in the table), the actual output waveform is zeroed for approximately 20 ms. Also note that, for large values of DC bias and amplitude, the actual output voltage will saturate outside of the range  $\pm 14.5$  V DC.

Table 3.4: Available DC Bias values by Amplitude setting

AC Amplitude (RMS)	DC Bias Range	DC Bias Resolution
10 mV – 10 V	$\pm 10$ V	1 mV
100 $\mu$ V – 9.99 mV	$\pm 100$ mV	10 $\mu$ V
1 $\mu$ V – 99.9 $\mu$ V	$\pm 1$ mV	100 nV
100 nV – 990 nV	$\pm 100$ $\mu$ V	10 nV

### 3.5 Automatic functions

The various automatic functions of the SR124 all involve the instrument performing some internal measurement and then adjusting a parameter as a result. This section discusses the constraints and required time for the functions.

#### 3.5.1 Auto-phase

The automatic phase cycle will adjust the phase setting of the SR124 to maximize the detected signal in Lock-in mode. Three steps occur in an auto-phase cycle:

1. The phase shift is internally set to  $0^\circ$ , and the instrument then pauses for 8 output Time Constant periods (for settling). At the end of the settling time, the voltage at the output is internally measured.
2. The phase shift is then internally set to  $90^\circ$ , and the instrument again waits 8 Time Constants for settling. At the end of this settling time, the output voltage is again measured.

3. From the four-quadrant arctangent of the two preceding measurements, the SR124 determines the nominal phase shift required for the user input signal, and programs the PHAS setting accordingly.

The entire auto-phase cycle requires  $16\times$  the output Time Constant setting to execute. For example, if the Time Constant is set to 3 s, the auto-phase will require 48 seconds.

### 3.5.2 Auto-gain

The automatic gain cycle adjusts the sensitivity setting of the SR124 to maximize the output signal without causing an overload.

If the instrument is not in an overload state when auto-gain is started, then the unit will begin decreasing the sensitivity (increasing the gain), one step at a time, until an overload is detected. At each setting, the SR124 pauses for 5 output Time Constants, or 500 ms (whichever is longer), for settling.

If no overload is ever detected, the instrument stops at 100 nV sensitivity. If an overload is detected, the sensitivity is increased one setting back to the point overload was not firing.

If the SR124 was already in Overload when auto-gain is started, then the sensitivity is increased (gain decreased), one step at a time, until the overload is cleared. The same delay of the longer of 5 time constants or 500 ms is used at each setting.

### 3.5.3 Auto-offset

The automatic offset cycle measures the current output voltage, and adjusts the output offset setting to attempt to null the current output. Since the measurement and offset driver both occur after the output filter time constant is applied, this function always executes promptly. Note that for proper results, the SR124 output should be stable before starting an auto-offset cycle.

### 3.5.4 Lock assist

The lock assist function is only used in external mode and can speed the PLL acquisition of a user's reference signal.

The lock assist first begins a frequency measurement of the Ext. In signal to determine the user input frequency. This step requires the greater of 2 s or 2 periods of the input signal.

The SR124 then determines if the frequency is in-range for the current setting of the reference Range (accounting for  $2\times f$  or  $3\times f$  operation,

if necessary).

If the frequency is valid for the current range, then the reference oscillator is temporarily halted, and the PLL tuning filter is “pre-charged” to the correct voltage for the desired frequency.

The final step in the process is to arm a comparator that waits for the next positive zero-crossing of the external frequency reference. When that comparator fires, the VCO oscillator is un-halted, and the oscillation begins (approximately) in-phase with the external reference.



---

## 4 Remote Operation

---

This chapter describes operating the SR124 over the remote interfaces.

### In This Chapter

<b>4.1</b>	<b>Index of commands</b>	<b>4-2</b>
<b>4.2</b>	<b>Alphabetic list of commands</b>	<b>4-4</b>
<b>4.3</b>	<b>Introduction</b>	<b>4-6</b>
4.3.1	Interface configuration	4-6
4.3.2	Buffers	4-6
4.3.3	Remote / local	4-6
<b>4.4</b>	<b>Commands</b>	<b>4-7</b>
4.4.1	Command syntax	4-7
4.4.2	Notation	4-8
4.4.3	Examples	4-8
4.4.4	Reference and phase commands	4-9
4.4.5	Input commands	4-11
4.4.6	Filter commands	4-12
4.4.7	Gain and time constant commands	4-13
4.4.8	Output commands	4-14
4.4.9	Setup commands	4-15
4.4.10	Auto commands	4-16
4.4.11	Data transfer commands	4-17
4.4.12	Interface commands	4-18
4.4.13	Status commands	4-20
<b>4.5</b>	<b>Status model</b>	<b>4-23</b>
4.5.1	Status byte (SB)	4-23
4.5.2	Service request enable (SRE)	4-24
4.5.3	Standard event status (ESR)	4-24

## 4.1 Index of commands

Symbol	Definition
$f, g$	Floating-point value
$i, j$	Unsigned integer
$z$	Literal token
(?)	Required for queries; illegal for set commands
<i>var</i>	Parameter always required
{ <i>var</i> }	Required parameter for set commands; illegal for queries
[ <i>var</i> ]	Optional parameter for both set and query forms

---

### Reference and phase

PHAS(?) { $f$ }	4 – 9	Reference phase
QUAD(?) { $z$ }	4 – 9	Phase quadrant
FMOD(?) { $z$ }	4 – 9	Reference mode
FREQ(?) { $f$ }	4 – 9	Reference oscillator frequency
SLVL(?) { $g$ }	4 – 10	Reference output amplitude
RSLP(?) { $z$ }	4 – 10	Reference slope shape
FRNG(?) { $z$ }	4 – 10	Reference oscillator range
BION(?) { $z$ }	4 – 11	Reference DC bias enable
BIAS(?) { $g$ }	4 – 11	Reference DC bias magnitude
FORM(?) { $z$ }	4 – 11	Reference output waveform

---

### Input

ISRC(?) { $z$ }	4 – 11	Input source
IGND(?) { $z$ }	4 – 12	Input shield grounding
ICPL(?) { $z$ }	4 – 12	Input coupling

---

### Filter

TYPF(?) { $z$ }	4 – 12	Input filter type
QFCT(?) { $z$ }	4 – 12	Input filter Q-factor
IFFR(?) { $f$ }	4 – 12	Input filter frequency
IFTR(?) { $g$ }	4 – 12	Input filter frequency trim
NCHD(?) { $g$ }	4 – 13	Input filter notch depth trim

---

### Gain and time constant

SENS(?) { $z$ }	4 – 13	Input sensitivity
RMOD(?) { $z$ }	4 – 13	Reserve mode
OFLT(?) { $z$ }	4 – 14	Output filter time constant
OFSL(?) { $z$ }	4 – 14	Output filter slope

---

### Output

OMOD(?) { $z$ }	4 – 14	Output mode
-----------------	--------	-------------



---

OFSE(?) {z}	4-14 Output offset enable
OFST(?) {g}	4-15 Output offset magnitude

---

**Setup**

KCLK(?) {z}	4-15 Key clicks
ALRM(?) {z}	4-15 Audible alarms
SSET(?) {z}	4-15 Save user settings
RSET(?) {z}	4-15 Recall user settings

---

**Auto**

AGAN(?) [z]	4-16 Auto gain
APHS(?) {z}	4-16 Auto phase
AOFF(?) {z}	4-16 Auto offset
AREF(?) {z}	4-17 Measure reference frequency
ASST(?) {z}	4-17 External lock-assist

---

**Data transfer**

OUTR?	4-17 Output
ORTI?	4-17 Output RTI

---

**Interface**

*IDN?	4-18 Identify
TOKN(?) {z}	4-18 Token Mode
*OPC(?)	4-18 Operation complete
LOCL(?) {z}	4-19 Local lockout
*RST	4-19 Reset

---

**Status**

LOCK?	4-20 Lock status
OVLDT?	4-20 Overload
*STB? [i]	4-21 Status byte
*SRE(?) [i,] {j}	4-21 Service request enable
*ESR? [i]	4-21 Standard event status
*ESE(?) [i,] {j}	4-21 Standard event status enable
*CLS	4-21 Clear status
LEXE?	4-21 Last execution error
LCME?	4-22 Last command error

## 4.2 Alphabetic list of commands

---

### ★

*CLS	4 – 21	Clear status
*ESE(?) [i,] {j}	4 – 21	Standard event status enable
*ESR? [i]	4 – 21	Standard event status
*IDN?	4 – 18	Identify
*OPC(?)	4 – 18	Operation complete
*RST	4 – 19	Reset
*SRE(?) [i,] {j}	4 – 21	Service request enable
*STB? [i]	4 – 21	Status byte

---

### A

AGAN(?) [z]	4 – 16	Auto gain
ALRM(?) {z}	4 – 15	Audible alarms
AOFF(?) {z}	4 – 16	Auto offset
APHS(?) {z}	4 – 16	Auto phase
AREF(?) {z}	4 – 17	Measure reference frequency
ASST(?) {z}	4 – 17	External lock-assist

---

### B

BIAS(?) {g}	4 – 11	Reference DC bias magnitude
BION(?) {z}	4 – 11	Reference DC bias enable

---

### F

FMOD(?) {z}	4 – 9	Reference mode
FORM(?) {z}	4 – 11	Reference output waveform
FREQ(?) {f}	4 – 9	Reference oscillator frequency
FRNG(?) {z}	4 – 10	Reference oscillator range

---

### I

ICPL(?) {z}	4 – 12	Input coupling
IFFR(?) {f}	4 – 12	Input filter frequency
IFTR(?) {g}	4 – 12	Input filter frequency trim
IGND(?) {z}	4 – 12	Input shield grounding
ISRC(?) {z}	4 – 11	Input source

---

### K

KCLK(?) {z}	4 – 15	Key clicks
-------------	--------	------------

---

### L

LCME?	4 – 22	Last command error
LEXE?	4 – 21	Last execution error

---

---

LOCK?	4-20	Lock status
LOCL(?) {z}	4-19	Local lockout

---

**N**

NCHD(?) {g}	4-13	Input filter notch depth trim
-------------	------	-------------------------------

---

**O**

OFLT(?) {z}	4-14	Output filter time constant
OFSE(?) {z}	4-14	Output offset enable
OFSL(?) {z}	4-14	Output filter slope
OFST(?) {g}	4-15	Output offset magnitude
OMOD(?) {z}	4-14	Output mode
ORTI?	4-17	Output RTI
OUTR?	4-17	Output
OVLN?	4-20	Overload

---

**P**

PHAS(?) {f}	4-9	Reference phase
-------------	-----	-----------------

---

**Q**

QFCT(?) {z}	4-12	Input filter Q-factor
QUAD(?) {z}	4-9	Phase quadrant

---

**R**

RMOD(?) {z}	4-13	Reserve mode
RSET(?) {z}	4-15	Recall user settings
RSLP(?) {z}	4-10	Reference slope shape

---

**S**

SENS(?) {z}	4-13	Input sensitivity
SLVL(?) {g}	4-10	Reference output amplitude
SSET(?) {z}	4-15	Save user settings

---

**T**

TOKN(?) {z}	4-18	Token Mode
TYPF(?) {z}	4-12	Input filter type

## 4.3 Introduction

Remote operation of the SR124 is through a simple command language documented in this chapter. Both set and query forms of most commands are supported, allowing the user complete control of the lock-in from a remote computer through RS-232, or through the optical fiber and the SX199 interface to GPIB, RS-232, or ethernet interfaces.

Where applicable, the corresponding front-panel interface to each command is also indicated. Most instrument settings are retained in non-volatile memory. Upon power-on, these settings are restored to their values before the power was turned off. Where appropriate, the default value for parameters is listed in **boldface** in the command descriptions.

Note that remote commanding does not function when the “Control Inhibit” toggle switch is in the upper position.

### 4.3.1 Interface configuration

Both RS-232 and optical fiber interfaces are fixed configuration, 9600 baud, 8-bit, with no parity or flow control.

### 4.3.2 Buffers

The SR124 stores incoming bytes from the remote interfaces in separate 128-byte input buffers. Characters accumulate in the input buffer until a command terminator ( $\langle CR \rangle$  or  $\langle LF \rangle$ ) is received, at which point the message is parsed and enqueued for execution. Query responses from the SR124 are buffered in interface-specific 256-byte output queues. Queries are returned to the interface from which they were received (RS-232 or optical).

If an input buffer overflows, then all data in the input buffer are discarded, and an error is recorded in the ESR status register.

### 4.3.3 Remote / local

Any time the SR124 receives a remote command terminator ( $\langle CR \rangle$  or  $\langle LF \rangle$ ), the instrument transitions into the “Remote” state. When in Remote (indicated by the *REM* annunciator in the Reference display block), no keypad input or knob adjustment is allowed. To return to front panel operation, press the [Recall] button (which also functions as the “local” key).

Alternatively, the SR124 can be returned to Local mode by sending the LOCL LOCAL command.

## 4.4 Commands

This section provides syntax and operational descriptions for remote commands.

### 4.4.1 Command syntax

The four letter mnemonic (shown in **CAPS**) in each command sequence specifies the command. The rest of the sequence consists of parameters.

Commands may take either *set* or *query* form, depending on whether the “?” character follows the mnemonic. *Set only* commands are listed without the “?”, *query only* commands show the “?” after the mnemonic, and *optionally query* commands are marked with a “(?)”.

Parameters shown in { } and [ ] are not always required. Parameters in { } are required to set a value, and should be omitted for queries. Parameters in [ ] are optional in both set and query commands. Parameters listed without surrounding characters are always required.

Do *not* send ( ) or { } or [ ] as part of the command.

Multiple parameters are separated by commas. Multiple commands may be sent on one command line by separating them with semicolons (;) so long as the input buffer does not overflow. Commands are terminated by either <CR> or <LF> characters. Null commands and whitespaces are ignored. Execution of the command does not begin until the command terminator is received.

**tokens** *Token* parameters (generically shown as z in the command descriptions) can be specified either as a keyword or as an integer value. Command descriptions list the valid keyword options, with each keyword followed by its corresponding integer value. For example, to set the reference mode to internal, the following two commands are equivalent:

FMOD INTERNAL    —or—    FMOD 1

For queries that return token values, the return format (keyword or integer) is specified with the **TOKN** command.

### 4.4.2 Notation

The following table summarizes the notation used in the command descriptions:

Symbol	Definition
<i>f, g</i>	Floating-point value
<i>i, j</i>	Unsigned integer
<i>z</i>	Literal token
(?)	Required for queries; illegal for set commands
<i>var</i>	Parameter always required
{ <i>var</i> }	Required parameter for set commands; illegal for queries
[ <i>var</i> ]	Optional parameter for both set and query forms

### 4.4.3 Examples

Each command is provided with a simple example illustrating its usage. In these examples, all data sent by the host computer to the SR124 are set as *straight teletype font*, while responses received by the host computer from the SR124 are set as *slanted teletype font*.

The usage examples vary with respect to set/query, optional parameters, and token formats. These examples are not exhaustive, and are intended to provide a convenient starting point for user programming.

#### 4.4.4 Reference and phase commands

---

PHAS(?) {f}	<p>Reference phase</p> <p>Set (query) the reference phase shift {to <math>f</math>}, in degrees. Phase must be in the range <math>0 \leq f &lt; 360</math>. The default value is PHAS 0.00.</p> <p><i>Example:</i> PHAS 30.25</p>
-------------	---

---

QUAD(?) {z}	<p>Phase quadrant</p> <p>Set (query) the phase quadrant {to quadrant <math>z=(I\ 1, II\ 2, III\ 3, IV\ 4)</math>}. Note that quadrants tokens are Roman numerals.</p> <p>The quadrants are defined so that QUAD I corresponding to <math>0^\circ \leq \phi &lt; 90^\circ</math>, QUAD II to <math>90^\circ \leq \phi &lt; 180^\circ</math>, and so on.</p> <p>Commanding a new value of QUAD adds or subtracts multiples of <math>90^\circ</math> to the current PHAS setting to bring the phase into the commanded quadrant.</p> <p><i>Example:</i> PHAS 105.25 QUAD? 2</p>
-------------	--

---

FMOD(?) {z}	<p>Reference mode</p> <p>Set (query) the reference mode {to <math>z=(EXT1F\ 0, INTERNAL\ 1, EXT2F\ 2, EXT3F\ 3, RVCO\ 4)</math>}.  </p> <p><i>Example:</i> FMOD INTERNAL</p>
-------------	--

---

FREQ(?) {f}	<p>Reference oscillator frequency</p> <p>Set (query) the reference oscillator frequency {to <math>f</math>}, in hertz. The default value is FREQ 1000.00.</p> <p>The set form of the command is only allowed when the oscillator mode is FMOD INTERNAL. The parameter <math>f</math> must be in the range defined by the FRNG command. Queries while in FMOD INTERNAL mode return the commanded oscillator frequency.</p> <p>Queries in either external or rear-VCO modes return the most recently measured value of the oscillator frequency. Note that the FREQ? query itself does not initiate a new measurement of the oscillator frequency. That action is performed with the AREF command.</p> <p><i>Example:</i> FREQ? 137.036000000</p>
-------------	---

---

---

**SLVL(?) {g}** Reference output amplitude

Set (query) the reference oscillator output amplitude {to *g*}, in volts RMS. The default value is **SLVL 0.100**.

Allowed values for SLVL may be restricted if the DC Bias is enabled. See section 3.4 for details.

*Example:* SLVL 1.5E-6

---

**RSLP(?) {z}** Reference slope shape

Set (query) the external reference input slope mode {to *z*=(**SINE 0**, **TTL 1**)}

RSLP is used to configure the external reference input trigger circuit. When set to RSLP SINE, the Ext. In BNC input is AC-coupled to a discriminator circuit armed to trigger on positive-going zero crossings. When set to RSLP TTL, the Ext. In connection is DC-coupled, and the discriminator looks for positive-going transitions crossing a +1 V threshold, compatible with TTL and CMOS logic.

*Example:* RSLP SINE

---

**FRNG(?) {z}** Reference oscillator range

Set (query) the reference oscillator range {to *z*=(FRNG.P2 0, FRNG.2 1, **FRNG.20 2**, FRNG.200 3, FRNG.2K 4)}.

In all modes, the oscillator range FRNG must first be set to the correct span for the desired *oscillator* frequency. If operating in one of the harmonic modes (FMOD EXT2F or EXT3F), the FRNG setting must span the harmonic frequency, which may not necessarily include the (lower) external input frequency. For example, if operating in second harmonic mode (FMOD EXT3F) and the external input is 1.5 kHz, the oscillator will lock to 4.5 kHz and the range must be set to FRNG FRNG.200 or FRNG FRNG.2K; it will *not* lock if set to FRNG FRNG.20.

Each range spans 2 decades, and overlaps its adjacent ranges by one decade each:

<i>z</i> Value	Frequency Range (Hz)
FRNG.P2 0	0.2 – 21
FRNG.2 1	2 – 210
FRNG.20 2	20 – 2.1 k
FRNG.200 3	200 – 21 k
FRNG.2K 4	2 k – 210 k

*Example:* FRNG 3.



---

**BION(?) {z}** Reference DC bias enable

Set (query) the reference output DC bias {to z=(**OFF 0**, **ON 1**)}.

Turning the bias on enables DC biasing of the reference output signal.

*Example:* BION 1

---

**BIAS(?) {g}** Reference DC bias magnitude

Set (query) the bias magnitude {to g}, in volts. The default value is **BIAS 0.00**.

Allowed values for **BIAS** may be restricted based on the value of **SLVL**. See section 3.4 for details.

*Example:* BIAS?  
0.001250000

---

**FORM(?) {z}** Reference output waveform

Set (query) the reference output waveform {to z=(**SQUARE 0**, **SINE 1**)}.

*Example:* FORM SINE

---

#### 4.4.5 Input commands

---

**ISRC(?) {z}** Input source

Set (query) the input source configuration {to z=(**A 0**, **AMINUSB 1**, **CUR1E6 2**, **CUR1E8 3**)}.

The first two settings (**ISRC A** and **ISRC AMINUSB**) select the voltage input preamp, configured for single-ended **A** input, or differential **AMINUSB** input.

The last two settings (**ISRC CUR1E6** and **ISRC CUR1E8**) select the current (transimpedance) amplifier. The current amplifier has a selectable gain of either 1 M $\Omega$  (10<sup>6</sup> V/A) or 100 M $\Omega$  (10<sup>8</sup> V/A). In either current configuration, the transimpedance gain is *in addition* to the overall voltage gain set by the **SENS** command.

For example, if **ISRC CUR1E8** and **SENS S50MV**, then the overall sensitivity corresponding to a full-scale (10 V) output is

$$50 \text{ mV} \times \frac{1}{10^8 \text{ V/A}} = 500 \text{ pA.}$$

*Example:* ISRC?  
0

---

---

IGND(?) {z}                      Input shield grounding  
 Set (query) the input shield grounding {to z=(FLOAT 0, **GROUND 1**)}.

*Example:* IGND 1

---

ICPL(?) {z}                      Input coupling  
 Set (query) the input source coupling {to z=(AC 0, **DC 1**)}.

*Example:* ICPL 1

---

#### 4.4.6 Filter commands

---

TYPF(?) {z}                      Input filter type  
 Set (query) the input filter configuration {to z=(BANDPASS 0, HIGHPASS 1, LOWPASS 2, NOTCH 3, **FLAT 4**)}.

*Example:* TYPF FLAT

---

QFCT(?) {z}                      Input filter Q-factor  
 Set (query) the input filter Q-factor {to z=(**Q1 0**, Q2 1, Q5 2, Q10 3, Q20 4, Q50 5, Q100 6, QENBW 7 )}.

The 10%-ENBW filter mode is set by QFCT QENBW.

*Example:* QFCT Q5  
 QFCT?  
 2

---

IFFR(?) {f}                      Input filter frequency  
 Set (query) the input filter frequency {to f}, in Hz. The default value is IFFR **1000.00**.

The allowed range is 2.0 to 110000.0 ( $2 \text{ Hz} \leq f \leq 110 \text{ kHz}$ ).

*Example:* IFFR **1000**

---

IFTR(?) {g}                      Input filter frequency trim  
 Set (query) the input filter frequency trim value {to g}. The default value is IFTR **0**.

The parameter g can range from  $-999 \leq g \leq +999$ , in dimensionless units.

*Example:* IFTR -128

---

---

**NCHD(?) {g}** Input filter notch depth trim

Set (query) the input filter notch depth trim value {to g}. The default value is NCHD **0**.

The parameter g can range from  $-999 \leq g \leq +999$ , in dimensionless units.

*Example:* NCHD?  
125.0000000000

#### 4.4.7 Gain and time constant commands

---

**SENS(?) {z}** Input sensitivity

Set (query) the full-scale input sensitivity setting {to z}. Allowable values are:

z Value	Full-scale sensitivity	z Value	Full-scale sensitivity
S100NV 0	100 nV	S500UV 11	500 $\mu$ V
S200NV 1	200 nV	S1MV 12	1 mV
S500NV 2	500 nV	S2MV 13	2 mV
S1UV 3	1 $\mu$ V	S5MV 14	5 mV
S2UV 4	2 $\mu$ V	S10MV 15	10 mV
S5UV 5	5 $\mu$ V	S20MV 16	20 mV
S10UV 6	10 $\mu$ V	S50MV 17	50 mV
S20UV 7	20 $\mu$ V	S100MV 18	100 mV
S50UV 8	50 $\mu$ V	S200MV 19	200 mV
S100UV 9	100 $\mu$ V	<b>S500MV 20</b>	500 mV
S200UV 10	200 $\mu$ V		

See ISRC command discription for a discussion of sensitivity when configured for current inputs.

*Example:* SENS?  
S100UV

---

**RMOD(?) {z}** Reserve mode

Set (query) the input sensitivity setting {to z=(HIGH 0, NORMAL 1, **LOWNOISE 2**)}.

*Example:* RMOD 1

---

**OFLT(?) {z}**                      Output filter time constant

Set (query) the output filter time constant setting {to z}. Allowable values are:

z Value	Full-scale sensitivity
TCMIN 0	< 500 $\mu$ s
TC1MS 1	1 ms
TC3MS 2	3 ms
TC10MS 3	10 ms
TC30MS 4	30 ms
<b>TC100MS 5</b>	100 ms
TC300MS 6	300 ms
TC1S 7	1 s
TC3S 8	3 s
TC10S 9	10 s
TC30S 10	30 s
TC100S 11	100 s
TC300S 12	300 s

*Example:* OFLT 7

---

**OFSL(?) {z}**                      Output filter slope

Set (query) the output filter slope (rolloff) {to z=(**SLOPE6DB 0**, **SLOPE12DB 1**)}.

*Example:* OFSL SLOPE12DB

#### 4.4.8 Output commands

---

**OMOD(?) {z}**                      Output mode

Set (query) the output mode {to z=(**LOCKIN 0**, **ACVOLT 1**)}.

*Example:* OMOD?  
LOCKIN

---

**OFSE(?) {z}**                      Output offset enable

Set (query) the output offset mode {to z=(**OFF 0**, **ON 1**)}.

*Example:* OFSE 1

---

**OFST(?) {g}**                      Output offset magnitude

Set (query) the output offset magnitude {to *g*}, in percent full scale. The default value is OFST **0.00**.

The allowed range for *g* is  $-1000 \leq g \leq +1000$  ( $\pm 10 \times$  full-scale).

*Example:* OFST 300.253

#### 4.4.9 Setup commands

---

**KCLK(?) {z}**                      Key clicks

Set (query) audible key clicks {to  $z=(\text{OFF } 0, \text{ON } 1)$ }.

Note there is no corresponding front-panel method to access this command; it is exclusive to the remote interface.

---

**ALRM(?) {z}**                      Audible alarms

Set (query) audible alarms {to  $z=(\text{OFF } 0, \text{ON } 1)$ }.

Note that all sounds that are not “key clicks” are considered “alarms” for the purpose of the ALRM command. There is no corresponding front-panel method to access this command; it is exclusive to the remote interface.

---

**SSET(?) {z}**                      Save user settings

Save (query) the user settings {to non-volatile block  $z=(\text{USER0 } 0, \text{USER1 } 1, \dots, \text{USER8 } 8)$ }.

The set version of SSET saves user settings to parameter block *z*. The query version SSET? returns the most block name or number *z* most recently saved into.

---

**RSET(?) {z}**                      Recall user settings

Retrieve (query) the user settings {to non-volatile block  $z=(\text{USER0 } 0, \text{USER1 } 1, \dots, \text{USER8 } 8, \text{DEFAULT } 9)$ }.

The set version of RSET retrieves user settings from non-volatile block *z* and reconfigures the SR124 to those settings. The query form simply returns the name/number of the most-recently retrieved memory block.

Note that RSET DEFAULT is equivalent to \*RST.

#### 4.4.10 Auto commands

The following commands all cause the SR124 to perform a series of internal measurements and adjustments. See section 3.5 for a discussion of how much time these functions may require.

---

##### AGAN(?) [z]

Auto gain

Set (query) the auto gain function {to z=(**OFF 0**, **ON 1**)}. Setting **AGAN** with no parameter will initiate an auto gain cycle, and is equivalent to **AGAN 1**.

The set version of **AGAN** can initiate an auto gain cycle by commanding **AGAN** to **ON (1)**. If a currently-executing auto gain must be cancelled in-progress, send the command **AGAN OFF**.

Querying **AGAN** will respond with one of the following 5 token values:

z value	Definition
<b>OFF 0</b>	Auto gain not running
<b>ON 1</b>	Auto gain adjust in progress
<b>NOTREADY 2</b>	Not currently possible to start
<b>SUCCESS 3</b>	Auto gain cycle concluded successfully
<b>FAILED 4</b>	Auto gain cycle failed

---

##### APHS(?) {z}

Auto phase

Set (query) the auto phase function {to z=(**OFF 0**, **ON 1**)}. Setting **APHS** with no parameter will initiate an auto phase cycle, and is equivalent to **APHS 1**.

The set version of **APHS** can initiate an auto phase cycle by commanding **APHS** to **ON (1)**. If a currently-executing auto phase must be cancelled in-progress, send the command **APHS OFF**.

Querying **APHS** will respond with one of the same 5 tokens as described above, for **AGAN**.

---

##### AOFF(?) {z}

Auto offset

Set (query) the auto offset function {to z=(**OFF 0**, **ON 1**)}. Setting **AOFF** with no parameter will initiate an auto offset cycle, and is equivalent to **AOFF 1**.

The set version of **AOFF** can initiate an auto offset cycle by commanding **AOFF** to **ON (1)**. If a currently-executing auto offset must be cancelled in-progress, send the command **AOFF OFF**.

The **AOFF** command can be executed independent of the **OFFO** state (whether the offset is enabled or not). The command **AOFF 1** measures the current value of the output, and adjusts the **OFST** parameter to best null the output voltage.

---

Querying AOFF will respond with one of the same 5 tokens as described above, for AGAN.

*Example:* AOFF 1

---

**AREF(?) {z}**                      Measure reference frequency

Set (query) the “measure the reference oscillator frequency” function {to z=(OFF 0, ON 1)}. Setting AREF with no parameter will initiate a reference frequency measurement cycle, and is equivalent to AREF 1.

The set version of AREF can initiate an auto measurement cycle by commanding AREF to ON (1). If a currently-executing auto offset must be cancelled in-progress, send the command AREF OFF.

Querying AREF will respond with one of the same 5 tokens as described above, for AGAN.

---

**ASST(?) {z}**                      External lock-assist

Set (query) the reference oscillator lock-assist function {to z=(OFF 0, ON 1)}. Setting ASST with no parameter will initiate an auto lock-assist cycle, and is equivalent to ASST 1.

The set version of ASST can initiate a lock-assist cycle by commanding ASST to ON (1). If a currently-executing auto lock-assist must be cancelled in-progress, send the command ASST OFF.

Querying ASST will respond with one of the same 5 tokens as described above, for AGAN.

#### 4.4.11 Data transfer commands

---

**OUTR?**                              Output

Query the output value, in volts. The range of OUTR? responses is always in the range  $-10 \leq \text{OUTR?} \leq +10$ .

---

**ORTI?**                              Output RTI

Query the output value, in volts, referenced to input.

The relationship between OUTP? and ORTI? is

$$\text{ORTI?} = (\text{OUTP?}/10 \text{ V}) \times V_{\text{FS}}$$

where  $V_{\text{FS}}$  is the full-scale voltage sensitivity, in volts. For example, if SENS=8 (S500V),  $V_{\text{FS}} = 50 \times 10^{-6}$  V. Then if OUTP?=+3.14, then ORTI? returns +0.000015700 (15.7  $\mu$ V input).

---

#### 4.4.12 Interface commands

---

*IDN?	<p>Identify</p> <p>Query the SR124 identification string.</p> <p>The response is formatted as:  Stanford_Research_Systems,SR124,s/n*****,ver#.##  where ***** is the 6-digit serial number, and #.## is the firmware revision level.</p> <p><i>Example:</i> *IDN?  Stanford_Research_Systems,SR124,s/n098023,ver1.00</p>
TOKN(?) {z}	<p>Token Mode</p> <p>Set (query) the token response mode {to z=(OFF 0, ON 1)}.</p> <p>Token response mode controls the formatting of response messages generated by the SR124 to remote queries of token-type values. When TOKN OFF, the SR124 responds with the numeric version of the token quantity. When TOKN ON, the text version is returned.</p> <p><i>Example:</i> TOKN?  ON</p>
*OPC(?)	<p>Operation complete</p> <p>The set form, *OPC, will set the OPC bit in the Standard Event Status register; the query form, *OPC?, will return the value 1.</p> <p>*OPC is useful for pacing streams of remote commands; the *OPC command will not be processed by the command execution of the SR124 until all preceding commands have been executed. This includes “slow” commands such as auto gain (AGAN).</p> <p>Note, however, that commands are considered completed once all hardware settings they require are made; analog settling times are <i>not</i> part of the normal “execution” process. As a result, *OPC should not be used to indicate that new instrument settings have settled; rather, the usefulness of *OPC is in assuring that the remote interface does not overflow or lose synchronization with a user’s application program.</p> <p><i>Example:</i> *OPC?  1</p>

---



---

**LOCL(?) {z}** Local lockout

Set (query) the local lockout {to z=(**LOCAL 0**, **REMOTE 1**, **LOCKOUT 2**)}. The LOCL command provides control over user access to front-panel control of the SR124. When LOCL REMOTE or LOCK LOCKOUT, the REM indicator will be lit; in this state, the user cannot control any instrument functions from the front panel.

When in LOCL REMOTE, the [Recall/Local] button acts as the “local” function, bringing the SR124 back to the LOCL LOCAL state with full front-panel control. Note, however, that in LOCL LOCKOUT, even the [Recall/Local] button is disabled: only a remote command returning the instrument to LOCL LOCAL, or a power cycle, will restore front-panel control.

Note that receipt of aa remote command terminator character places the instrument into the LOCL REMOTE state.

*Example:* LOCL LOCKOUT

---

**\*RST** Reset

Reset the SR124 to its default configuration.

The following commands are internally executed upon receipt of the \*RST command:

- PHAS 0.0
- FMOD
- FREQ 1000.0
- SLVL 0.100
- FRNG FRNG.20
- BION OFF
- BIAS 0.0
- FORM SINE
- ISRC A
- IGND GROUND
- ICPL DC
- TYPF FLAT
- QFCT Q1
- IFFR 1000.0
- IFTR 0
- NCHD 0
- SENS S500MV
- RMOD LOWNOISE
- OFLT TC100MS

- OFSL SLOPE6DB
- OMOD LOCKIN
- OFSE OFF
- OFST 0.0
- KCLK ON
- ALRM ON

#### 4.4.13 Status commands

---

LOCK?	<p>Lock status</p> <p>Reads the current value of the reference oscillator lock status. Returns a token, with values z=(UNLOCKED 0, LOCKED 1, or NOTPLL 2).</p> <p>If the SR124 reference oscillator is operating in one of the external reference modes (FMODEXT1F, FMODEXT2F, or FMODEXT3F), then the query LOCK? will return either UNLOCKED 0 or LOCKED 1 based on the current status.</p> <p>If the SR124 reference oscillator is configured for either FMODEINTERNAL or FMODERVC0, then LOCK? responds with NOTPLL 2.</p> <p><i>Example:</i> LOCK? LOCKED</p>
OVLD?	<p>Overload</p> <p>Reads the current value of the signal overload status. Returns an integer between 1 and 15 if an overload is detected, or 0 if there is no overload.</p> <p>The response integer is binary-weighted based on the four (4) separate signal stages that can generate an overload detect:</p> <ul style="list-style-type: none"> <li>• 1 Preamp overload</li> <li>• 2 Current amp overload</li> <li>• 4 Intermediate (AC) amp overload</li> <li>• 8 Output (DC) amp overload</li> </ul> <p>For example, if the preamp and the intermediate amp are both overloading, OVLD? will respond with 5 (= 1 + 4).</p> <p><i>Example:</i> OVLD? 0</p>

---

---

*STB? [i]	<p>Status byte</p> <p>Reads the Status Byte register [bit i].</p> <p><i>Example:</i> *STB? 0</p>
-----------	--

---

*SRE(?) [i,] {j}	<p>Service request enable</p> <p>Set (query) the Service Request Enable register [bit i] {to j}.</p> <p><i>Example:</i> *SRE 0, 1</p>
------------------	---

---

*ESR? [i]	<p>Standard event status</p> <p>Reads the Standard Event Status Register [bit i].</p> <p>Upon executing *ESR?, the returned bit(s) of the ESR register are cleared.</p> <p><i>Example:</i> *ESR? 64</p>
-----------	---

---

*ESE(?) [i,] {j}	<p>Standard event status enable</p> <p>Set (query) the Standard Event Status Enable Register [bit i] {to j}.</p> <p><i>Example:</i> *ESE 6, 1 ESE? 64</p>
------------------	---

---

*CLS	<p>Clear status</p> <p>*CLS immediately clears the ESR register, and the UNLOCK and OVERLOAD bits in the Status Byte.</p> <p><i>Example:</i> *CLS</p>
------	---

---

LEXE?	<p>Last execution error</p> <p>Query the last execution error code. A query of LEXE? always clears the error code, so a subsequent LEXE? will return 0. Valid codes are:</p> <table border="1" style="margin-left: 40px; border-collapse: collapse;"> <thead> <tr> <th style="text-align: left;">Value</th> <th style="text-align: left;">Definition</th> </tr> </thead> <tbody> <tr> <td>0</td> <td>No execution error since last LEXE?</td> </tr> <tr> <td>1</td> <td>Illegal value</td> </tr> <tr> <td>2</td> <td>Wrong token</td> </tr> <tr> <td>3</td> <td>Invalid bit</td> </tr> <tr> <td>4</td> <td>Queue full</td> </tr> <tr> <td>5</td> <td>Not compatible</td> </tr> </tbody> </table>	Value	Definition	0	No execution error since last LEXE?	1	Illegal value	2	Wrong token	3	Invalid bit	4	Queue full	5	Not compatible
Value	Definition														
0	No execution error since last LEXE?														
1	Illegal value														
2	Wrong token														
3	Invalid bit														
4	Queue full														
5	Not compatible														

---

*Example:* IFFR 1234567; LEXE?; LEXE?  
1;0

The error (1, “Illegal value,”) is because the parameter value (1234567) is too large for IFFR. The second read of LEXE? returns 0.

---

**LCME?**

Last command error

Query the last command error code. A query of LCME? always clears the error code, so a subsequent LCME? will return 0. Valid codes are:

Value	Definition
0	No execution error since last LCME?
1	Illegal command
2	Undefined command
3	Illegal query
4	Illegal set
5	Missing parameter(s)
6	Extra parameter(s)
7	Null parameter(s)
8	Parameter buffer overflow
9	Bad floating-point
10	Bad integer
11	Bad integer token
12	Bad token value
13	Bad hex block
14	Unknown token

*Example:* \*IDN  
LCME?  
4

The error (4, “Illegal set”) is due to the missing “?”.

## 4.5 Status model

status registers The SR124 status registers follow the hierarchical IEEE–488.2 format. A block diagram of the status register array is given in Figure 4.1.

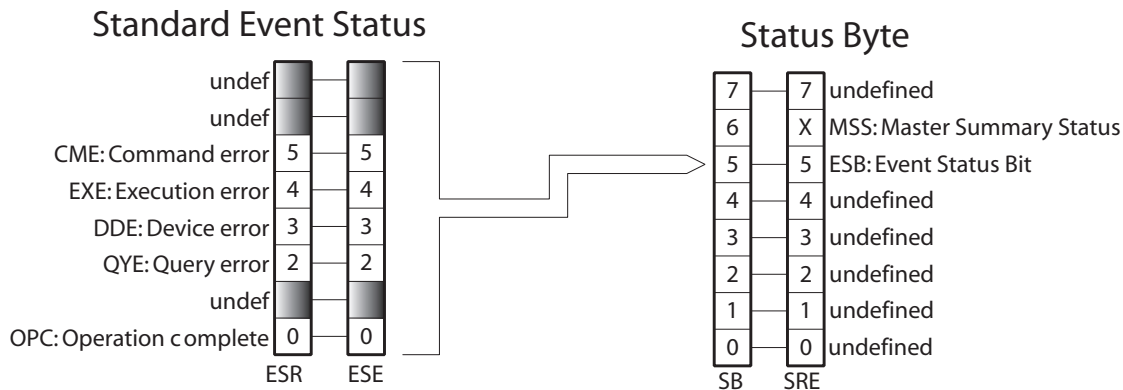

Figure 4.1: Status Model for the SR124 Analog Lock-In Amplifier

There are three categories of registers in the status model of the lock-in:

- Event Registers : These read-only registers record the occurrence of defined events within the lock-in. If the event occurs, the corresponding bit is set to 1. Upon querying an event register, any set bits within it are cleared. These are sometimes known as “sticky bits,” since once set, a bit can only be cleared by reading its value. Event register names end with SR or EV.
- Enable Registers : These read/write registers define a bitwise mask for their corresponding event register. If any bit position is set in an event register while the same bit position is also set in the enable register, then the corresponding summary bit message is set in the Status Byte. Enable register names end with SE or EN.
- Status Byte : This read-only register represents the top of the status model, and is populated with summary bit messages and interface condition bits. Enabled bits within the Status Byte generate the remote Request Service event.

At power-on, all status registers are cleared.

### 4.5.1 Status byte (SB)

The Status Byte is the top-level summary of the SR124 status model. When enabled by the Service Request Enable register, a bit set in the Status Byte causes the MSS (Master Summary Status) bit to be set.

Weight	Bit	Flag
1	0	undef (0)
2	1	undef (0)
4	2	undef (0)
8	3	undef (0)
16	4	undef (0)
32	5	ESB
64	6	MSS
128	7	undef (0)

ESB : Event Status Bit. Indicates whether one or more of the enabled events in the Standard Event Status Register is true.

MSS : Master Summary Status. Indicates whether one or more of the enabled status messages in the Status Byte register is true.

This register is read with the \*STB? query.

#### 4.5.2 Service request enable (SRE)

Each bit in the SRE corresponds one-to-one with a bit in the SB register, and acts as a bitwise AND of the SB flags to generate MSS. Bit 6 of the SRE is undefined—setting it has no effect, and reading it always returns 0. This register is set and queried with the \*SRE(?) command.

At power-on, this register is cleared.

#### 4.5.3 Standard event status (ESR)

The Standard Event Status Register consists of 8 event flags. These event flags are all “sticky bits” that are set by the corresponding events, and cleared only by reading or with the \*CLS command. Reading a single bit (with the \*ESR? *i* query) clears only Bit *i*.

Weight	Bit	Flag
1	0	OPC
2	1	undef (0)
4	2	QYE
8	3	DDE
16	4	EXE
32	5	CME
64	6	undef (0)
128	7	undef (0)

OPC : Operation Complete. Set by the \*OPC command.

QYE : Query Error. Indicates data in the output queue has been lost.

DDE : Device-Dependent Error. Indicates an internal command queue overflow.

EXE : Execution Error. Indicates the error in a command that was successfully parsed. Out-of-range parameters are an example.

CME : Command Error. Indicates a command parser-detected error.

#### 4.5.3.1 Standard event status enable (ESE)

The ESE acts as a bitwise AND with the ESR register to produce the single-bit ESB message in the Status Byte Register (SB). The register can be set and queried with the \*ESE(?) command.

At power-on, this register is cleared.





---

## 5 Circuits

---

This chapter presents a brief description of the SR124 circuit design. A complete parts list and circuit schematics are included.

### In This Chapter

5.1	Overview of circuits . . . . .	5-2
5.2	Power Supply . . . . .	5-2
5.3	CPU . . . . .	5-2
5.4	Front Panel . . . . .	5-2
5.5	Main board . . . . .	5-2
5.6	Oscillator . . . . .	5-4
5.7	Rear outputs . . . . .	5-5
5.8	Communications . . . . .	5-5
5.9	Schematics . . . . .	5-5

## 5.1 Overview of circuits

The following sections correspond to schematic pages at the end of the manual.

## 5.2 Power Supply

The SR124 power supply board uses low-voltage AC power from the shielded transformer to power the instrument. Separate power nets are created for the oscillator, the main signal board, and the CPU / Front-panel boards. A single “star ground” is established on the power supply board, where it is connected to the instrument chassis.

## 5.3 CPU

The CPU board contains the microcontroller that configures all instrument hardware of the SR124. Non-volatile memory on the CPU board stores user settings. The fully stopable CPU oscillator is also on this board.

## 5.4 Front Panel

The front panel board contains the LED indicators and button controls. All numeric displays are driven from static shift registers, whose values are only updated in response to a user command.

## 5.5 Main board

The Main board contains the front-end voltage and current preamplifiers, programmable filters, the PSD (square-wave mixer), the output filters, and the reference output attenuator.

The input JFET, Q1101, is quite sensitive and may be damaged by overvoltage, including overvoltage from a static discharge (ESD). Symptoms of a damaged JFET can be excess noise or signal loss.

Instructions for replacing the input JFET are as follows:

1. Equipment needed:
  - Replacement JFET (obtained from SRS)
  - BNC grounding cap or 50  $\Omega$  terminator
  - Voltmeter capable of showing millivolts
  - Test leads with small clips, to attach to test point loops
  - Small adjusting screwdriver

2. Work should be performed at an ESD-controlled workstation. Be sure the technician is grounded before opening the instrument.
3. Turn off power to the unit, and remove the AC power cord. Disconnect all other cables from the SR124. Remove the top lid of the instrument by removing the 2 large black screws from either side of the lid, and the 6 small black screws from the top of the lid. Slide the lid slightly backwards, and then lift away from the instrument.
4. Locate the input JFET, marked as Q1101 on the main circuit board. You can find Q1101 directly behind the A/I and B inputs, about 5 cm back from the edge of the board. Q1101 is socketed, as shown in Figure 5.1. Using your thumb and forefinger, carefully remove the JFET.

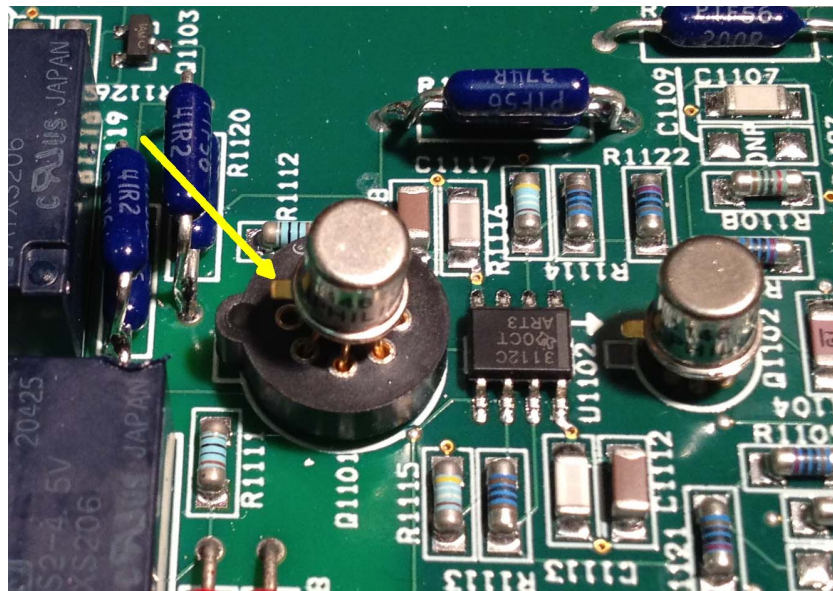

Figure 5.1: The front-end JFET (Q1101), installed.

5. The replacement JFET will be installed in the same socket. Please note that two of the socket positions, aligned with the front and back of the instrument, are left unpopulated. It is important that the pins of the new JFET all be seated correctly in the remaining positions. Refer to Figure 5.2 for the unpopulated positions. When fully seated, the JFET should look like Figure 5.1.
6. After replacing the JFET, the offset voltage must be trimmed to near zero. Power must be applied to the SR124 with the top

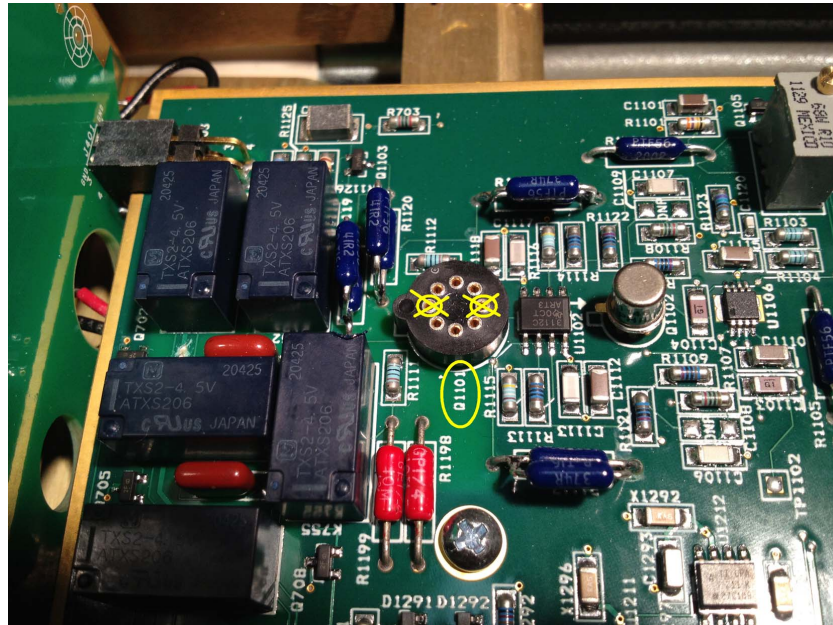

Figure 5.2: The front-end JFET (Q1101) socket, un-installed.

cover removed. Be sure to have a second person nearby for safety, and do not proceed if the metal shroud covering the AC power entry module has been removed.

7. Place a shorting cap or 50  $\Omega$  terminator onto the A/I input, and turn the instrument on. Press [Recall], and turn the **REFERENCE** knob to show “dEFLt”. Press [Recall] a second time to restore defaults. Turn the **SENSITIVITY** knob to 5 mV.
8. Attach the voltmeter test leads to Test Points TP1104 and TP1105 (see Figure 5.3). Slowly adjust trimmer R1102 to null the voltage between TP1104 and TP1105. You should be able to reduce the voltage to < 5 mV.
9. Return the top cover and reinstall all the screws.

## 5.6 Oscillator

The Oscillator board contains the quadrature sinewave voltage-controlled oscillator. This board is mounted vertically, at the right-hand side of the SR124 chassis.

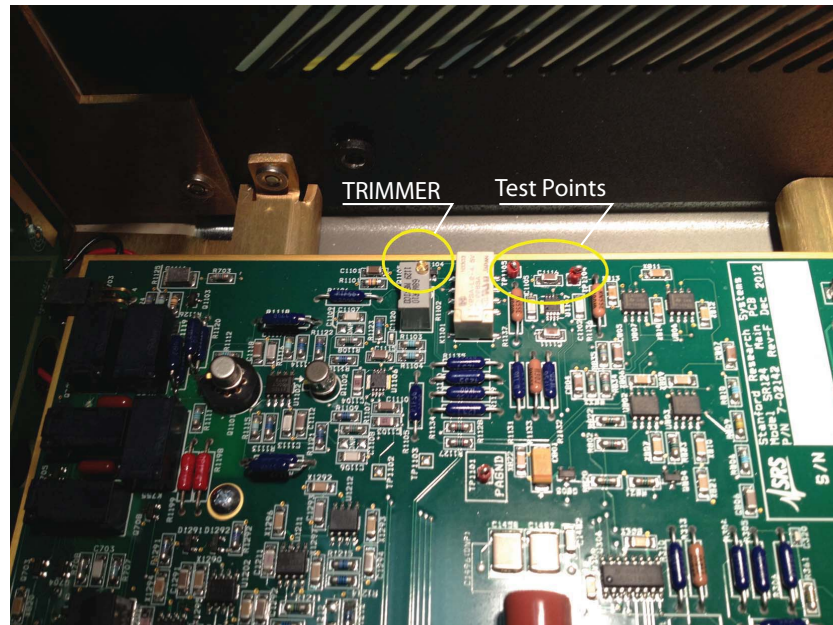

Figure 5.3: Trimming the replacement JFET

## 5.7 Rear outputs

The Rear outputs board contains the fully-differential buffer amplifiers to receive the oscillator quadrant signals and drive them relative to chassis ground.

## 5.8 Communications

The small Communications board, located near the power-entry module, contains the fiber optic transmit and receive components. A simple RS-232 driver circuit is also on this board.

## 5.9 Schematics

Circuit schematic diagrams follow this page.